

ANNEXURE-4

# TECHNICAL SPECIFICATIONS

CONSTRUCTION OF INDIA PAVILION FOR THE WORLD EXPO 2025 TO BE HELD IN OSAKA, JAPAN ON DETAILED DESIGN, ENGINEERING, PROCUREMENT AND CONSTRUCTION BASIS TOGETHER WITH SERVICES FOR INTERIOR DESIGN AND DECORATION, OPERATIONS AND COMPREHENSIVE MAINTENANCE DURING THE EXPO AND SUBSEQUENT DISMANTLING OF THE INDIA PAVILION.



CLIENT

INDIA TRADE PROMOTION  
ORGANISATION



# INDIA TRADE PROMOTION ORGANISATION

CONSTRUCTION OF INDIA PAVILION FOR THE WORLD EXPO 2025 TO BE HELD IN OSAKA, JAPAN ON DETAILED DESIGN, ENGINEERING, PROCUREMENT AND CONSTRUCTION BASIS TOGETHER WITH SERVICES FOR INTERIOR DESIGN AND DECORATION, OPERATIONS AND COMPREHENSIVE MAINTENANCE DURING THE EXPO AND SUBSEQUENT DISMANTLING OF THE INDIA PAVILION.

## TECHNICAL SPECIFICATION (March 2024)

CLIENT

INDIA TRADE PROMOTION  
ORGANISATION



**TECHNICAL SPECIFICATION**  
**CONSTRUCTION OF INDIA PAVILION – WORLD EXPO 2025 AT,**  
**OSAKA (JAPAN)**

<b>Chapter</b>	<b>TITLE</b>	<b>Page No.</b>
1.	General & Architecture	1-11
2.	Roof Structural Timber Specification	12-19
3.	Civil Structures	20-44
4.	Plumbing	45-124
5.	Fire fighting	125-160
6.	Electrical Work	161-279
7.	HVAC	280-322
8.	BMS	323-371
9.	Horticulture	372-380
10.	Audio/Video System	381-402
11.	Makes of Equipment	403-417

# CONSTRUCTION OF INDIA PAVILLION AT WORLD EXPO 2025, OSAKA (JAPAN) TECHNICAL specifications (GENERAL & ARCHITECTURE)

## 1 Chapter A

### BRIEF OF REQUIREMENT OF THE WORK:

#### 1.1 Introduction:

- i. The scope of work relates to Construction of India Pavilion – World Expo 2025, Osaka (Japan). The work is to be executed Design, Engineering, Procurement & Construction (EPC) basis as laid down in the Master Plan, Concept plans, Design Brief Report and tender drawings including Operation & Maintenance of buildings/services after completion and handing over in phases and up to the expiry of the defect liability period of complete project.
- ii. The scope of work shall also include Electrical works, Mechanical works, Electronic works, Plumbing, Sanitary, Sewerage, Storm water drainage, & Fire-Fighting works etc. including maintenance during defect liability period including & preparation of all detailed shop drawings, obtaining approval from all local authorities, electrical inspector, water, sewer, drainage, electricity connection from local bodies, etc. to be executed as integral part of the project.
- iii. The following are the salient features of the Works:
  1. Foundations & other works
  2. Super structure
  3. Water proofing treatment works
  4. Aluminum door and windows, aluminum partition etc.
  5. Jali work, façade work, Structural glazing work.
  6. Anti-termite chemical treatment
  7. Internal and External water supply, Sewerage, Storm water drainage
  8. Infrastructure Development i.e. Roads, Parking, Pathways etc.
  9. Electrical Installation (Internal & External)
  10. Fire Fighting System
  11. HT & LT Installation, Substation, DG Sets
  12. HVAC & BMS
  13. Fire Alarm, PA, CCTV, EPABX/Telephone, LAN Systems etc.
  14. Solar PV, Solar Street Light & Solar Hot Water Systems
  15. Signage
  16. Landscape & Horticulture Works, Hard Landscaping in Courtyards, water bodies etc.
  17. Boundary wall with Entry/Exit gates

## 1.2 General

- i. The work shall in general conform to the Latest Osaka Expo norms and guidelines and all the relevant codes of Japan as applicable to the Scope of Work (corrected up to the last date of submission/uploading of bid) as mentioned in Schedule F of the General Conditions of Contract (GCC). Work under this Contract shall consist of furnishing all labour, materials, equipment, tools & plants and appliances necessary and required.
- ii. These Technical Specifications are to be read with the Technical Specifications mentioned in Schedule –F of the General Conditions of Contract. In case of any discrepancy, these technical specifications shall prevail.
- iii. The Contractor shall conduct his work, so as not to interfere with or hinder the progress or completion of the work being performed by other Contractor(s) or by the Engineer-in-Charge and shall as far as possible arrange his work and shall place and dispose of the materials being used or removed, so as not to interfere with the operations of other Contractor simultaneously working or he shall arrange his work with that of the others in an acceptable and coordinated manner and shall perform it in proper sequence to the complete satisfaction of others,
- iv. Regarding testing of civil & electrical & other materials, the testing of materials shall be conducted in Govt. Laboratory/ Govt. Engineering Colleges/ IITs/ NITs or from the laboratory approved by Engineer-in-charge/approved Laboratories in Japan. The charges of testing of materials in approved laboratory shall be borne by the Contractor.
- v. No payment shall be made for any damage caused by rain, snowfall, flood or any other natural calamity, whatsoever during the execution of the work. The Contractor shall be fully responsible for any damage to the govt. property and work for which the payment has been advanced to him under the contract and he shall make good the same at his risk and cost. The Contractor shall be fully responsible for safety and security of his material, T&P, Machinery brought to the site by him.
- vi. The Contractor shall comply with the safety procedures, norms and guidelines (as applicable in Osaka, Japan). However, if certain codes there are not available, then in that case, National Codes such as Constructional practices and safety- 2016, National Building code of India, Bureau of Indian Standards, NFPA are also shall be applicable. A copy of all pertinent regulations and notices concerning accidents, injury and first-aid shall be prominently exhibited at the work site. Depending upon the scope & nature of work, a person qualified in first-aid shall be available at work site to render and direct first-aid to casualties. A telephone may be provided to first-aid assistant with telephone numbers of the hospitals displayed. Complete reports of all accidents and action taken thereon shall be forwarded to the competent authorities.
- vii. The Contractor shall ensure the following activities for construction workers safety, among other measures:
  - a. Guarding all parts of dangerous machinery.

- b. Precautionary signs for working on machinery
  - c. Maintaining hoists and lifts, lifting machines, chains, ropes, and other lifting tackles in good condition.
  - d. Durable and reusable formwork systems to replace timber formwork and ensure that formwork where used is properly maintained.
  - e. Ensuring that walking surfaces or boards at height are of sound construction and are provided with safety rails or belts.
  - f. Provide protective equipment; helmets etc.
  - g. Provide measures to prevent fires. Fire extinguishers and buckets of sand to be provided in the fire-prone area and elsewhere.
  - h. Provide sufficient and suitable light for working during night time.
- viii. The Contractor shall provide for adequate number of garbage bins around the construction site and the workers facilities and will be responsible for the proper utilization of these bins for any solid waste generated during the construction. The Contractor shall ensure that the site and the workers facilities are kept litter free. Separate bins should be provided for plastic, glass, metal, biological and paper waste and labeled in both Japanese and English with suitable symbols.
- ix. Contractor should spray curing water on concrete structure and shall not allow free flow of water. Concrete structures should be kept covered with thick cloth/gunny bags and water should be sprayed on them. Contractor shall do water ponding on all sunken slabs using cement and sand mortar.
- x. The Contractor shall remove from site all rubbish and debris generated by the Works and keep Works clean and tidy throughout the Contract Period. All the serviceable and non-serviceable (malba) material shall be segregated and stored separately. Malba, rubbish & other waste materials shall be disposed of as directed/ approved by Engineer in Charge and necessary documentations shall be submitted to Engineer-in-charge. In this regard directives of National Green Tribunal or any other authority shall be a binding on Contractor.
- xi. Approved Makes:

Specification/brands names of materials to be used as per the scope of work are listed in the bid documents. The efforts should be made by the Contractor to use indigenous products. The Contractor should also consider the availability of spares parts/ components for maintenance purposes while proposing any brand/ manufacturer. The materials of any other brand/manufacturer may be proposed for use by the Contractor in case the brands specified below are not available in the market and/or Contractor intends to use some other brand better than the brands mentioned in this list. The alternate brand can be used only after the approval of Engineer-in-Charge. The list of approved makes is appended to this document.

xii. Method Statement:

The Contractor shall submit a 'Methods statement' for each important activity for the approval of the Engineer-in-charge soon after the award of work to him. The 'Methods statement' is a statement by which the construction procedures for any activity of construction are formulated and stated in chronological order. The 'Methods statement', should have a description of the item with elaborate procedures in steps to implement the same, the specifications of the materials involved, their testing and acceptance criteria, equipment to be used, Precautions to be taken, etc.

### 1.3 Setting Out

- i. The Contractor shall carry out survey of the whole work area, setting out the layout of building in consultation with the Engineer -in-Charge & proceed further. Any discrepancy between the Engineer-in-charge, architectural drawings and actual layout at site shall be brought to the notice of the Engineer -in-charge. It shall be responsibility of the Contractor to ensure correct setting out of alignment. Total station survey instruments only shall be used for layout, fixing boundaries, and center lines, etc.
- ii. The Contractor shall establish, maintain and assume responsibility for grades, lines, levels and benchmarks. He shall report any errors or inconsistencies regarding grades, lines, levels, dimensions etc. to the Engineer -in-Charge before commencing work. Commencement of work shall be regarded as the Contractor's acceptance of such grades, lines, levels, and dimensions and no claim shall be entertained at a later date for any errors found.
- iii. If at any time, any error appears due to grades, lines, levels and benchmarks during the progress of the work, the Contractor shall, rectify such error, if so required, to the satisfaction of the Engineer -in-Charge.
- iv. Though the site levels are indicated in the drawings the Contractor shall ascertain and confirm the site levels with respect to benchmark from the concerned authorities. The Contractor shall protect and maintain temporary/ permanent benchmarks at the site of work throughout the execution of work. These benchmarks shall be got checked by the Engineer-in-Charge or his authorized representatives. The work at different stages shall be checked with reference to bench marks maintained for the said purpose.
- v. The approval by the Engineer-in-Charge, of the setting out by the Contractor, shall not relieve the Contractor of any of his responsibilities and obligation to rectify the errors/ defects, if any, which may be found at any stage during the progress of the work or after the completion of the work.
- vi. The Contractor shall be entirely and exclusively responsible for the horizontal, vertical and other alignments, the level and correctness of every part of the work and shall rectify effectively any errors or imperfections therein. Such rectifications shall be carried out by the Contractor to the entire satisfaction of the Engineer - in-Charge.
- vii. The contractor(s) shall carry out soil/geotechnical investigation and should satisfy himself about complete characteristics of soil and other parameters at site. The details w.r.t soil strata, bearing capacity etc. given in the DBR are indicative and no claim on the alleged inadequacy or incorrectness of the soil data supplied by the department shall be entertained. The intending Contractor shall conduct soil investigations on their own, and shall be responsible for the adequacy of the design.

## 1.4 Coordinated Drawings

- I. Before taking up the work, the contractor shall prepare shop drawings for the works listed below for various civil and electrical & other services showing details of lay out in plan including sections & elevations & large-scale details and contractor shall plan and mobilize his resources as per these drawings and as per actual site conditions to facilitate convenient execution, installation as well as maintenance of these items.

- II. **Shop Drawings:**

The scope of work, technical specifications and drawings together shall be considered as a tender requirement and the work shall be carried out as per shop drawings, prepared & submitted by the Contractor and duly approved by Engineer-in-charge. The contractor shall study the GFC drawings and taking into account actual site conditions and selected material and requirements, shall prepare shop drawings as fully coordinated drawings. Such drawings shall be prepared for the works, not limited to the following works:

- a. Aluminium work & Structural glazing.
- b. Expansion joint work
- c. Stone cladding work
- d. Suspended ceiling work, coordinated with all ceiling related services.
- e. Marble, granite, vitreous, ceramic, tile work
- f. All Electrical work
- g. All Sanitary work
- h. All HVAC works
- i. Horticulture
- j. Electric Sub-station
- k. DG sets
- l. CCTV & Access Control
- m. Audio Visual
- n. Pumps
- o. Solar panels.
- p. Signages.

The shop drawings shall be prepared and submitted for approval well in advance to achieve the milestones provided.

- III. Within the time frame agreed with the Engineer-in-charge, the contractor shall prepare shop drawings using latest version of Auto CAD. Shop drawings shall show all layouts, details in plans & sections showing all connections, junctions, bends, supports, clearances. Fixing arrangements with dimensions room, etc. shall be prepared by the contractor on Auto-CAD based on the architectural drawings and site measurements. All measurable items quantities shall be mentioned on each shop drawing being submitted for approval by the contractor. 3 sets of shop drawings (soft copy also) shall be submitted for approval and Seven sets of final shop drawings after approval by Engineer-in-charge shall be submitted by the contractor along with the soft copy. The shop drawings shall be prepared as per agreed schedule. Technical



submittals of manufacturer 's catalogues and technical data shall be submitted for approval. The contractor shall designate an Engineer responsible for issue and preparation of shop drawings and control of GFC drawings.



### 1.5 Scale of Amenities: -



- i. The doors and windows/flooring shall be provided as per the requirements indicated in the finishing schedules/tender drawings/ Japanese Norms for residential buildings and technical specifications. In case of variance, the decision of Engineer in charge shall prevail.
- ii. A Chart Listing Various Scale of Amenities to be provided in Various Units shall be as given in the Vol-2, DBR, of tender document.



### 1.6 Bamboo Based Finishing Material: -

Bamboowood is an environmentally friendly substitute for hardwood. It is completely made from bamboo. Bamboowood is natural and stronger than most hardwood in the market. A stunning invention, Bamboowood offers the durability and luxurious finish of hardwood without the ecological damage.

Sr. No.	Nomenclature	Reference Picture
1	<p><b>Bamboowood 14mm thick Tile Flooring including quarter round &amp; door reducers</b></p> <p>Providing &amp; fixing in position Phenol bonded Bamboowood flooring with planks of sizes 14mm thick, 1800mm length (minimum) and 130mm wide (minimum), in approved colour, texture and finish. The flooring shall be fixed with tongue and groove installation system, with an underlayment of 4mm thick expanded poly ethylene foam sheets having density of 18kg/cum, over prepared surface with necessary quarter round planks of size 1900mm x 18mm and door reducer of size 1900mm x 44mm, wherever required. The bamboowood planks are to finished with ultraviolet coating. The Bamboowood products are to adhere to ASTM E 84 Class A standard and shall have a toxicity of less than 5 as per NES 713 standard. The Bamboowood planks shall have minimum density of 1000 kg/cum &amp; minimum Hardness 1000 Kgf.</p>	

<p>2</p>	<p><b>Bamboowood 10mm thick Wall Cladding including Threshold</b></p> <p>Providing &amp; fixing in position Phenol bonded Bamboowood wall cladding at all height with planks of sizes 10mm thick, 1800mm length (minimum) and 130 mm wide (minimum) approved colour, texture and finish. The planks are fixed with customised clips over the cold form galvulium sections anchored to the wall and covered with 2mm thick expanded poly ethylene foam of density 18kg/cum in one layer on wall surface before fixing cold form sections. The Bamboowood products are to adhere to ASTM E 84 Class A standard and shall have a toxicity of less than 5 as per NES 713 standard. The Bamboowood planks shall have minimum density of 1000 kg/cum &amp; minimum Hardness 1000 Kgf. with Eco friendly UV coating.</p>	
<p>3</p>	<p><b>Bamboowood Wainscoting</b></p> <p>Providing &amp; fixing in position Phenol bonded Bamboowood Wainscoting having ply as a backlayment. Bamboowood Wainscoting is to be supplied in approved color, texture, and finish as per the approved design. The C-Channel framing having size of 40mm x 10mm x 1mm and is to be used to support the wainscoting over the wall. Framing is to be done to achieve single plane level keeping minimum overall thickness with necessary concealed hardware and accessories and levelling clips for easy adjustment. Plywood of 8mm thickness shall be laid on top of framework. Modular Wainscoting Panel of minimum height of 950mm completely factory finished in ready to installed condition in combination with 6mm ply and CNC routed Decorating beading to create a pattern. All the open edges are to be covered with the Bamboowood pre-shaped batten. Epoxy solvent-based Polyurethane coating is to be used on all exposed surfaces for protection from weathering effect as per the manufacturer's specification. The Bamboowood products are to adhere to ASTM E 84 Class A standard and shall have a toxicity of less than 5 as per NES 713 standard. The Bamboowood planks shall have minimum density of 1000 kg/cum &amp; minimum Hardness 1000 Kgf. with Eco friendly UV coating.</p> <p>Skirting is to installed over the wainscoting touching the FFL level from the bottom and the measurement and rate for the it to be considered separately.</p>	
<p>4</p>	<p><b>Bamboowood Bespoke Ceiling with 16mm rafter and Centre spacing of 70 mm</b></p> <p>Providing &amp; Fixing in position phenol bonded strand woven compressed Bamboowood, bespoke baffle ceiling of the panel with equal spacing grid for perfect alignment. The panel comprising of customized bamboowood rafter of thickness 16mm with a height of 65mm and a center spacing of 70 mm. Customized bamboowood rafters of Bamboowood, in approved color/texture/finish. The panels are coated with seven layers of UV rays absorbing termite resistance anti-yellowing acrylic-based clear PU coating system having a film formation thickness of nearly 0.55mm to 1.15mm and deposition equals in a range of 95gms to 135gms per sq.mtr. The</p>	

	<p>baffles need to be arranged and fixed in a way to form a panel with a customized C-bracketing channel along with accessories that automatically control the center to center distance and to have the flexibility to match the length as per the site requirements. The entire panel is to be mounted on a steel grid with minimum testing standards and Self-certified for its quality conformity. The Bamboowood products are to adhere to ASTM E 84 Class A standard and shall have a toxicity of less than 5 as per NES 713 standard. The Bamboowood planks shall have minimum density of 1000 kg/cum &amp; minimum Hardness 1000 Kgf. with Eco friendly UV coating.</p>	
<p>5</p>	<p><b>Bamboowood Bespoke Ceiling with 16mm rafter and Centre spacing of 70 mm</b></p> <p>Providing &amp; Fixing in position phenol bonded strand woven compressed Bamboowood, bespoke baffle ceiling of the panel with equal spacing grid for perfect alignment. The panel comprising of customized bamboowood rafter of thickness 16mm with a height of 65mm and a center spacing of 70 mm. Customized bamboowood rafters of Bamboowood, in approved color/texture/finish. The panels are coated with seven layers of UV rays absorbing termite resistance anti-yellowing acrylic-based clear PU coating system having a film formation thickness of nearly 0.55mm to 1.15mm and deposition equals in a range of 95gms to 135gms per sq.mtr. The baffles need to be arranged and fixed in a way to form a panel with a customized C-bracketing channel along with accessories that automatically control the center to center distance and to have the flexibility to match the length as per the site requirements. The entire panel is to be mounted on a steel grid with minimum testing standards and Self-certified for its quality conformity. The Bamboowood products are to adhere to ASTM E 84 Class A standard and shall have a toxicity of less than 5 as per NES 713 standard. The Bamboowood planks shall have minimum density of 1000 kg/cum &amp; minimum Hardness 1000 Kgf. with Eco friendly UV coating.</p>	
<p>6</p>	<p><b>Bamboowood Round Pole Baffle Ceiling of 60mm Dia with 200mm CTC</b></p> <p>Providing &amp; Fixing in position phenol bonded Bamboowood, bespoke round pole of 60mm diameter. Bespoke bamboowood round pole Baffle ceiling is to be installed with equal spacing grid of Poles over Metal structure for perfect alignment. The panel comprising of bespoke bamboowood round poles of diameter 60mm and a center to center (C to C) spacing of 200mm. The bamboowood poles are to be assembled to form a hollow section with sufficient internal strengthening members. The bespoke bamboowood round poles are to be coated with PU coating in approved colour, texture and finish. The round poles need to be arranged and fixed in a way to form a panel with a customized C-bracketing channel along with accessories that automatically control the center to center distance, and to have the flexibility to match the length as per the site requirements. The entire panel is to be mounted on an MS grid having minimum wall thickness to</p>	

	<p>1.0mm, the supporting structure is to suspended using full threaded rod with minimum standards and Self-certified for its quality conformity. The Bamboowood products are to adhere to ASTM E 84 Class A standard and shall have a toxicity of less than 5 as per NES 713 standard. The Bamboowood planks shall have minimum density of 1000 kg/cum &amp; minimum Hardness 1000 Kgf.</p>	
<p>7</p>	<p><b>Bamboowood Ceiling</b></p> <p>Providing &amp; fixing in position Phenol bonded Bamboowood planks of size 10 mm thick,1800 mm length (minimum) and 130 mm wide (minimum) used in False Ceiling Work. The bamboowood planks shall be fixed with necessary profiled edges; placed under covered shed as suspended ceiling on steel open grid system. Frame work made of steel coldform sections running parallel at 900~1200mm centre to centre distance and connected with same intermediate channel at 400~600mm c/c perpendicular and fixed together with screws and also held in position with GI 'L' section on the periphery with screws. Whole frame work held in suspended form with dash fastener 6 mm x 25 mm with GI hanger rod having adjustable butterfly clip for levelling and connected with roof truss/ slab with cleat and rawl plugs at adequate c/c. The Bamboowood products are to adhere to ASTM E 84 Class A standard and shall have a toxicity of less than 5 as per NES 713 standard. The Bamboowood planks shall have minimum density of 1000 kg/cum &amp; minimum Hardness 1000 Kgf.</p>	
<p>8</p>	<p><b>Bamboowood panelling or panelling and glazing in panelled and glazed shutters for doors of 25 to 40mm thick</b></p> <p>Providing &amp; fixing in position Phenol bonded Bamboowood paneling of 10mm thick, in 25 to 40 mm thick shutters for doors, windows, clerestorey windows in approved colours, texture &amp; finishes. Bamboo wood planks shall have minimum density of 1000 kg/cum &amp; minimum Hardness 1000 Kgf. The panels shall have profiled interlocking system locked in place with bamboo pins. The Bamboowood products are to adhere to ASTM E 84 Class A standard and shall have a toxicity of less than 5 as per NES 713 standard. The Bamboowood planks shall have minimum density of 1000 kg/cum &amp; minimum Hardness 1000 Kgf, with polyurethane coating. (Area of opening for panel inserts excluding portion inside grooves or rebates)</p>	

9	<p><b>Bamboowood glazed shutters for doors &amp; windows of 25 to 40mm thick</b></p> <p>Providing of fixing, in position Phenol bonded Bamboowood panelled or paneled and glazed shutters for doors, windows, clerestorey windows with pre-molded 30mm thick planks, in approved colours, texture &amp; finish. It shall have 10mm wide, 25mm deep groove to fit in panels. The Bamboowood products are to adhere to ASTM E 84 Class A standard and shall have a toxicity of less than 5 as per NES 713 standard. The Bamboowood planks shall have minimum density of 1000 kg/cum &amp; minimum Hardness 1000 Kgf, with polyurethane coating. All styles and rails shall have profiled interlocking system locked in place by bamboo pins (The panelling and accessories will be paid for separately)</p>	
---	---	---

Make: Epitome / Eco Green Floor OR Equivalent

**Performance Test result of Bamboowood:** Bamboowood confirms following tests / norms:

Performance Characteristics	Test Method	Criteria
Gloss Value	DIN EN ISO 2813	30 ± 5%
Scratch Resistance	Coin Test	No Scratch
Scratch Resistance	Steel wool Type 2	No Scratch
Cross Cut Test	DIN EN ISO 2409	≤ GT 2
Scratch Resistance	Hamburger test	≥ 20 N
Abrasion Resistance	DIN EN 438-2	> 100cycle
Abrasion Resistance	ASTM D 4060	>6000 cycle
Scratch Resistance	ISO 15184	≥ 1H
Impact Resistance	DIN EN 438 P2-12	≥ 2 Newton
Indentation Resistant	DIN EN 438 P -14	≥ 1 Newton
Chemical Resistance	DIN 68861 Part 1	5
In flammability	DIN 4102 Part 14	B1
Heat Resistance	DIN 68861 Part 6	6A
Slip Resistance	DIN 18032-2	0.4 – 0.6

**Note:** The Code given are indicative however the contractor before procuring & executing the work shall ascertain & determine the applicable Japanese codes, which are required to be complied with Osaka Japan, and only there after the respective material should be used.

**As per Annexure-3a (Finishing Schedule) the specifications of material, application procedure shall be as per the manufacturer’s guidelines.**

## 1.7 Waterproofing: -

- i. The roof & wet areas such as the toilet and kitchen, should be made waterproof for the entire expo period. An appropriate waterproofing strategy should be applied, such as using membrane admixture like FRP (Fiber-Reinforced Plastics, or Fiber-Reinforced Polymers), crystalline coatings over various surfaces such as wood and metal. This ensures there is no ingress of water and it should be made waterproof while considering any seismic measures. The use of FRP (Fiber-Reinforced Plastics or Polymers) in waterproofing strategies provides several advantages.
- ii. FRP materials offer high strength and durability, making them effective for reinforcing vulnerable areas prone to water penetration, such as joints and corners. Additionally, FRP can be molded and applied in various forms to conform to irregular surfaces, ensuring comprehensive coverage and protection against leaks.

## 2 Chapter B

### TECHNICAL specifications FOR ROOF STRUCTURAL TIMBER SPECIFICATION

#### 2.1 GENERAL

##### Section Content

- i. Cross reference: Refer to the General building requirements section for general technical requirements.
- ii. Specifications in this section: Structural timber elements, including Glu-laminated timber (Glulam) and other timber as specified on Structural drawings.
- iii. Cost: All items and associated costs referred to in this Specification and the Structural/Civil drawings shall form part of the Contractor's tender price, unless noted otherwise.

#### 2.2 Cross References

- i. General: Refer to General requirements section for general technical requirements.
- ii. Related Sections: Refer to the following sections: Architectural specification, Architectural finishes specification.

#### 2.3 Standard

- i. Specified in this section: The provision, fabrication, erection and connection of all Structural Timber Elements including Glulam. Any reference documents referred to are for a guide only and the contractor shall source all appropriate codes and the latest editions are to be adopted.
- ii. General Structural Timber Design: To latest applicable JIS, JBSL, AIJ, JAS code.
- iii. Design service life of roof structure to be compliant with applicable Japanese codes.

**Note: All Indian standards codes (IS) will be Replaced with JIS/JAS/AIJ Relevant Applicable Japanese Code along with the respective values.**

#### 2.4 Abbreviations

Glulam: Glu-laminated timber

#### 2.5 Protection

Requirement: Protect timber and timber products stored on site from moisture and weather, to ensure that the moisture content as specified on the drawings is not exceeded. For milled, prefinished, prefabricated and the like elements which are protected in the final structure, provide temporary weather protection until the permanent covering is in place. All materials handling is to be done in accordance with the manufacturer's guidelines. Any exposed timber faces are to be protected during transport. The Sub-contractor shall make reasonable allowance to make good any exposed timber elements that are damaged during transport.

## 2.6 Finishes

The sub-contractor is to coordinate the finishes to the system as documented within the following: Structural Drawings, Architectural Drawings, Architectural Finishes Specification. Where structural timber is exposed in the design, the sub-contractor is to provide a sample to the architects for their approval. The sub-contractor is to submit the appearance grade of the exposed timber in relation to applicable standard to the Client for their approval. All exposed structural timber elements are required to meet the appearance grade to applicable standard. The structural timber is to be protected in accordance to the durability grade required. This protection includes:

- i. Sealant to the end grain of structural timber beams and columns which are external but protected from the weather.
- ii. Physical barriers are to be applied to the end grain of structural timber beams and columns permanently fully exposed to weathering and capping to beams permanently fully exposed to weathering.
- iii. Sealant to the end grain of all structural timber beams and columns which are classified as internal as to prevent moisture ingress during construction due to temporary exposure to weathering.

## 2.7 Adjoining Elements

General: Obtain the requirements for adjoining building elements to be fixed to or supported on the Structural Timber and provide for the required fixings. Where applicable provide for temporary support of the adjoining elements during erection of the Structural Timber.

## 2.8 General Requirements

- i. General: The contractor is to allow for any Structural Timber required as may be necessary to complete the works as documented but not necessarily shown on the architectural and structural drawings.
- ii. Method: Fabricate and erect the Structural Timber in a safe manner, without interfering with or damaging adjacent structures, using methods complying with the requirements of all relevant Japanese Standards, manufacturers specifications, authorities and statutory requirements for materials, construction, fabrication and erection.
- iii. Cost: All items and associated costs referred to in this Specification and the drawings shall form part of the contract price, unless noted otherwise. All materials are to be supplied including wastage and over-supply construction.
- iv. Notice: Should any ambiguity, error, omissions, discrepancy or other faults exist or seem to exist in the contract documents then promptly notify in writing to the Architect.

## 2.9 Approved Subcontractors

- i. Requirement: The proposed fabricator, shop detailer and other specialist subcontractors shall be specified by the contractor and reviewed by the Architect during the tender submission.
- ii. Structural timber connection shop drawings and fabricators shall be specified by the contractor and reviewed by the Architect during the tender submission.



- iii. Sub-Contractor to provide characteristic values for structural timber elements for review prior to fabrication. These characteristic values must be greater than or equal to the minimum characteristic values set out by applicable Japanese Standards and equivalent to the material characteristics indicated on the drawings.

## 2.10 Handling and Storage

- i. General: To relevant Japanese Standards and manufacturers specifications. Handle and store all structural timber elements so as to protect it from damage, including overstress, distortion, damage to surfaces and applied finishes, contamination by foreign matter, and the like. The moisture content of the structural timber as indicated on the drawings is to be maintained at all times.
- ii. Structural timber elements are not to be left exposed to the weather for extended periods of time. Any exposed timber faces are to be protected during transport.

## 2.11 Variations to Structural Drawings

Should the Contractor request changes to the design/drawings, then the Contractor is to liaise with the Architect and allow for all co-ordination and shop drawings to suit this process and shall be at the Contractors expense.

## 2.12 Proprietary Products

- i. Where proprietary products are nominated on the drawings or in the specification, the Contractor shall provide in writing to the Architect, from the proprietary product manufacturer, certification and warranty that the product is suitable for its intended use in the project prior to the product being ordered or used. The manufacturer shall visit the site during construction and at completion of construction to certify in writing that the work has been carried out in accordance with their requirements. It is also the responsibility of the manufacturer to ensure that individual components of the proprietary product have not been substituted with alternative products.
- ii. Alternative to Proprietary Products: An alternative product having the required properties may be offered for review. The Architect may in his absolute discretion approve or rejects the alternative. No claim shall arise from any rejection.
- iii. Unless otherwise agreed, alternatives shall not be grounds for any claim for variation to cost or time. When offering an alternative for review, provide all available technical information, and any other relevant information requested by the Architect. If so requested, the contractor shall obtain and submit reports on relevant tests by an independent testing authority.

## 2.13 Contractors Submissions

- i. General: Where test results and or certificates are required by this specification, the contractor is to supply prior to the issuing of the Post-tender appointed Engineer's structural inspection certificate their own certification that all the Glulam and associated connection items supplied for the project have been tested in accordance with, and meets the requirements of, the specification and

structural drawings. Any non-conformances or elements that have not been tested are to be highlighted and confirmed as soon as the non-conformance has been identified.

- ii. Surface Finishes: Prior to the issuing of the Post-tender appointed Engineer's structural inspection certificate the contractor is to provide their own certification that the surface finishes have been applied, tested and inspected in accordance with the specification including surface preparation and the applied DFT (dry film thicknesses).

#### 2.14 Alternative Structural Timber Supplier

- i. Glulam have been designed using sizes prevalent in the market and material properties. However, if the required size is not available than contractor may substitute with due approval from the PDMA.
- ii. Alternative Glulam manufacturers may be considered provided material properties are similar and can achieve the fire resistance level as nominated on the structural drawings. If alternate manufacturer is proposed, detailed information would be required in a specific format for technical review.
- iii. Should the contractor wish to change the structural timber supplier from the design drawings, this may be subject to additional fees to be borne by the contractor.

#### 2.15 QUALITY CONTROL

##### Quality Assurance

- i. Requirement: A quality management system complying with the appropriate current Japanese Standard is required for a specified product or service, or in any case where the supplier already has in place such a system, provide assurance of quality in terms of that system.
- ii. Program: Submit a copy of the Contractors quality assurance program with the tender. During the construction phase, the Contractor shall provide a written verification to the Architect that they have completed a quality assurance and control procedure on the construction works detailed in the specifications and drawings.
- iii. Quality control: The Contractor shall submit their Construction Method Statement and Inspection Test Plan for each work procedure to the Architect for approval.

#### 2.16 Data Submissions

Requirement: Before installation commences, obtain and submit the following data:

- i. Manufacturer's data: The manufacturer's published product data

- ii. Testing authority's reports: Test reports certified by an independent testing authority showing compliance with the test criteria.
- iii. Product warranties: The manufacturer's written statement certifying that the product complies with the specification and is suitable for the intended use.
- iv. Samples: Exposed timber element with appearance grade nominated on architectural drawings.
- v. Subcontractors: Submit names and contact details of proposed fabricator and installer.
- vi. Shop drawings: Supply shop drawings of the structural timber elements to fully develop and co-ordinate the details that may or may not be included in the design documentation showing the relevant details of each assembly, component and connection, together with information relative to fabrication, surface treatment and erection, and others.
- vii. Fabrication: Commence fabrication only with the Architect's instruction and only with final reviewed shop drawings.
- viii. Work-as-executed drawings: Required for all workshop drawings. Execution
- ix. Survey certificates: For all structural timber elements, provide a survey to ensure that all are within tolerances. These are to be certified by a licensed surveyor.
- x. Erection: If members cannot be properly erected, give notice.
- xi. Identification marks: If members and/or connections are to be exposed to view submit details of proposed marking.
- xii. Distortions: Submit proposals for preventing or minimizing distortion of structural timber elements during transport and handling, submit proposals for intended rectification of distorted panels.

## 2.17 Product Data

Requirement: Before installation commences provide the following information:

The Manufacturer's published product data including:

1. Technical specifications
2. Recommendations for installation
3. Type test or factory test data.

Testing authorities reports: Test reports certified by an independent testing authority showing compliance with the criteria of specified tests.

Product warranties: The Manufacturer's written statement certifying the product complies with the Specification and is suitable for the intended use. The Contractor's written guarantee that the structural timber products installed comply with all relevant Japanese Standards and the Engineer's Specification and drawings.

Wood species: All Glulam elements as per Japanese norms.

All CLT elements

## 2.18 Non-Confirming Work

Where a section of works does not comply with the requirements of the specification and drawings (including requirements for materials, sections sizes, inspection and testing) the Contractor shall submit a non-conformance report detailing the proposed rectification method to the Architect for approval. Where the Architect deems that the proposed

rectification method and work is to be reviewed and/ or inspected by the relevant consultant(s), including but not limited to review, inspection, design and documentation shall be at the contractor's expense.

### Inspection

It is the Contractors responsibility to construct the works in accordance with the specifications and drawings and any inspections by the Architect or their representatives shall not be construed as relieving or relaxing this requirement.

Documents: Keep copy of all specifications, latest drawings and drawing list on site. Drawings stamped/approved by Architect should be held on site.

## 2.19 MATERIALS AND COMPONENTS

Structural Timber type and Strength Grade

Standards

Structural Timber: To latest applicable JIS, JBSL, AIJ, JAS.

## 2.20 Structural Timber Elements

- i. Adhesives: All adhesives product data sheets are to be supplied by the manufacturer, prior to fabrication.
- ii. Preservatives: All details of any preservative treatments are to be supplied for acceptance by the certifier prior to fabrication.
- iii. Moisture Content: All Glulam to be manufactured at moisture content % to be as per Japanese code.
- iv. Fire Resistance: Unless noted on the structural drawings, the contractor is to ensure all timber satisfies statutory Fire Compliance requirements.

## 2.21 Connection Items

- i. General: Alternative connection designs to be submitted to Architect for review.
- ii. Screws, Nails, Bolts, Dowels  
General: Hot dipped galvanized, corrosion free coated in oil and in serviceable condition. Screw and nail edge distances and minimum spacings to be in accordance with applicable Standards and manufacturers specifications.
- iii. Anchor points for installation to also comply with edge distance requirements.
- iv. Brackets  
General: Hot dipped galvanized, corrosion free coated in oil and in serviceable condition. Brackets to be clean, untainted and undamaged when erected in final position.
- v. Final condition to be fire rated according to architect's specifications.

## 2.22 EXECUTION

### Fabrication

- i. Fabricate in a workshop approved by Architect unless otherwise specified or permitted.
- ii. Structural timber elements subject to plastic deformation prior to placement in final condition to be reviewed. Completed members shall be free from twists, bends and local curves.
- iii. Provide structural members in lengths shown on the structural drawings.
- iv. Proposal to correct panels manufactured with a curve to be reviewed.
- v. Other than work shown on the shop drawings as site work do not fabricate or post-process structural timber elements on site without the post-tender appointed Engineer's instruction.
- vi. Fabrication Tolerances: To manufacturers specifications.
- vii. Straightness: To manufacturers specifications.
- viii. Availability: If structural timber elements are not available in the section, grade or length specified, obtain approval before substituting other products.

### 2.23 Erection

- i. The contractor is to provide temporary bracing during erection to maintain stability of the structural timber elements during construction.
- ii. Standard: To manufacturers specifications.
- iii. Erection Tolerances: To manufacturers specifications.
- iv. The contractor is to maintain an erection tolerance of +/- mm to be as per Japanese code, or as specified on the drawings, whichever is lesser.
- v. Do not attach lifting points or brackets without prior approval except as shown on shop drawings. Remove temporary connections on completion and restore the surface.
- vi. Fix temporary members so as not to weaken or deface permanent structural timber elements.
- vii. Erection techniques are the responsibility of the erector. Temporary bracing is to be removed only after completion of the structure.
- viii. Do not over stress or deform members or components.
- ix. Structural timber elements to be stored clear of the ground and protected from the weather, according to manufacturer's specifications.

## 2.24 COMPLETION

- i. Remove temporary connections on completion and restore the surface to match adjacent areas.
- ii. Provide the workshop drawings and survey certificates with all field modifications to the Architect for “as built” drawings.
- iii. Provide all Quality Record sheets.

**Note: The Code given are indicative however the contractor before procuring & executing the work shall ascertain & determine the applicable Japanese codes, which are required to be complied with Osaka Japan, and only there after the respective material should be used.**

## 3 Chapter C

### TECHNICAL specifications FOR CIVIL STRUCTURES

#### 1.0 GENERAL

##### 1.1 Scope

This specification governs the Sub-structure Civil, Structural, and Civil Finishing Works to be undertaken by the Contractor, specifically for compliance with Japanese construction standards. It shall be read in conjunction with the general conditions of the contract, drawings, rate schedule, and other documents forming part of this contract. In cases of ambiguity, guidance should be sought from the Project Manager, and adherence to relevant Japanese building codes and Osaka municipal ordinances is mandatory, following the Project Manager's approval.

##### 1.1 Site Preparations

The Contractor is responsible for clearing the site, including rubbish removal, vegetation clearance, and the extraction of disused foundations or obstructions encountered during excavation. Consultation with the Project Manager is essential to identify vegetation and trees to be preserved.

##### 1.3 Site Levels

The Contractor shall conduct comprehensive site surveys to establish grids and level marks approved by the Project Manager, who will determine the plot's general and plinth levels based on these surveys.

##### 1.4 Benchmarks

In collaboration with the Project Manager, the Contractor shall establish several undisturbed benchmarks across the site, the quantity of which depends on the site's size, before construction begins.

##### 1.5 Site investigation

The Project Manager might have got the soil investigation done and if so, the report will be handed over to the contractor for their scrutiny. The contractor shall however inspect the site and study the findings from the trial pits or bores in order to assess the problems involved in and methods to be adopted for excavation and earthwork. The contractor shall ascertain for himself all information concerning the sub-soil conditions, Ground water table periods and intensity of rainfall, flooding of the site and all data concerning excavation and earthwork. Any extra work required on this account, nothing will be paid extra.

#### **1.6**    **Setting out the work.**

The contractor shall set out the works and during the progress of the building shall amend at his own cost any errors arising from inaccurate setting out.

During the execution of the work contractor must cross check his work with the drawings. The contractor shall be responsible for all the errors in this connection and shall have to rectify all defects and/or errors at his own cost, failing which the Project Manager reserves the right to get the same rectified at the risk and cost of the contractor.

#### **1.7**    **Cleaning up and handing over.**

Upon completion, the site must be thoroughly cleaned to the Project Manager's satisfaction. This includes removing all construction debris and cleaning the immediate surroundings. The Contractor must provide the Project Manager with all relevant warranties, maintenance manuals, and keys upon project completion.

#### **1.8**    **Samples**

Prior to work commencement, the Contractor must obtain approval from the Project Manager for all material samples, including but not limited to precast concrete, masonry units, and finishing materials. The Contractor must submit a detailed materials approval schedule within four weeks of receiving the commencement order, outlining timelines for sample submission, approval, order placements, and mock-up completions.

#### **1.9**    **Tests**

All materials and testing methods must comply with Japanese standards, where applicable. The Project Manager reserves the right to test any materials, rejecting those that fail to meet specifications. The contract rates are deemed to include the cost of these tests.

#### **1.10**    **Mode of Measurements**

Measurements for the work will adhere to standards compatible with Japanese construction practices, ensuring compliance with local regulations and requirements.



## 2.0 SITE DEVELOPMENT AND EARTH WORK FOR FLOATING FOUNDATION

### 2.1 General

This section outlines the site preparation and earthwork strategies specific to the implementation of a floating foundation, emphasizing the importance of meticulous site clearance and preparation to facilitate construction activities. The contractor is responsible for assessing the site conditions and planning excavation work accordingly. No additional compensation will be provided for unforeseen ground conditions.

### 2.2 Excavation for Floating Foundations:

The excavation will be precisely conducted to the dimensions required for the floating foundation, under the direct supervision of the Project Manager. The foundation bed will be prepared to exact specifications, ensuring optimal conditions for the floating foundation. Any adjustments or corrections needed will be addressed with suitable materials at the contractor's expense, maintaining the focus on achieving a stable and effective foundation.

### 2.3 Soil Types and Excavation Strategy

Soil will be categorized as follows confirming to Japanese standard (Recommended Procedures for Planning Soil Investigations for Design of Building Foundations, 2009, AIJ Recommendations for Design of Ground Improvement for Building Foundations, 2006, and Evaluation of foundation soil for design and construction of building foundations, 2015) with methods adapted for a floating foundation. Soil will be categorized as follows, with methods adapted for a floating foundation:

2.3.1 Soft Soil: Includes clay, shale, and other soils that necessitate careful excavation to avoid disturbing the balance needed for a floating foundation.

2.3.2 Decomposed Rock: Easily workable rock or boulders that can be managed with mechanical means without requiring blasting, in line with the delicate nature of preparing for a floating foundation.

2.3.3 Prohibited Blasting: Blasting is strictly prohibited to preserve the integrity of adjacent soils and structures, crucial for the stability of a floating foundation and it is to be noted that construction is being executed on artificial island of Japan. Alternative methods such as non-explosive demolition agents may be employed.

2.3.4 Project Manager's Oversight: The Project Manager will oversee soil classification, ensuring excavation strategies are compatible with the floating foundation requirements.

2.3.5 Slope Stabilization: Slopes and excavation sides will be secured and shaped meticulously to maintain site integrity, with any unstable sections addressed promptly, aligning with the foundational stability requirements of floating foundations.

2.3.6 Shoring for Floating Foundations: Shoring strategies will be designed to safeguard the excavation area without impeding the placement or performance of the floating foundation. Any required modifications due to soil movement will be managed effectively by the contractor.

- 2.3.8 Dewatering with Care: Maintaining a dry excavation site is critical for floating foundation placement. The contractor will implement comprehensive dewatering measures, ensuring no impact on soil conditions or foundation stability.
- 2.3.9 Excavation Maintenance: The contractor is responsible for keeping the excavation area clear of any debris or water accumulation, ensuring a clean and stable environment for foundation work.
- 2.3.10 Backfilling for Stability: Backfilling will be executed with materials approved by the Project Manager, compacted to specifications that support the floating foundation's stability. Any material from excavation deemed suitable will be utilized, ensuring compatibility with foundation requirements.
- 2.3.11 Surplus Management: Excess materials will be removed from the site in an orderly manner, considering environmental and site cleanliness standards. of the Project Manager regarding the location in which each type of excavated material is to be used according to its quality. In case the excavated materials are not approved for backfilling, either totally or in part or if their quantity falls short of the quantity required for filling, suitable materials shall be brought to site from an approved source.

## 3.0 PLAIN AND REINFORCEMENT CEMENT CONCRETE WORKS

### 3.1 General Compliance

All concrete work must adhere to this section's general requirements, superseded only by clauses specific to certain applications, which then take precedence. All the quality and execution must meet Japanese standards:

- i. Recommendation for Detailing and Placing of Concrete Reinforcement – 2010.
- ii. Recommendation for Detailing and Placing of Reinforcement on Steel Reinforced Concrete Structures, 2005.
- iii. Recommendation for Design and Practice of Reinforced Concrete Building with Portland Blast-Furnace Slag Cement or Ground Granulated Blast-Furnace Slag, 2017.
- iv. Recommendations for Practice of Concrete with Eco cement, 2007.

### 3.2 Quality Control and Supervision

A qualified supervisor must oversee all concrete preparation and placement phases, ensuring strict adherence to Japanese standards for materials testing and equipment calibration.

### 3.3 Materials

#### a) Cement

Cement must meet Japanese standards:

- i. Ordinary Portland cement (OPC) complying with JIS R 5210 should be used as a standard practice.
- ii. Cement must be fresh upon delivery, stored properly, and not used if it has formed lumps.
- iii. The source of cement must be pre-approved, and any change requires re-validation through trial mixes.

#### b) Fine & Coarse Aggregates

- i. Should be from reputable sources known for quality suitable for concrete. Must be chemically inert, durable, and free from impurities. Adhere to JIS standards for testing aggregates' suitability.
- ii. Aggregate and sand of quality and grading specified herein above shall be used. Admixture of sand obtained by crushing natural stone may be permitted by the Project Manager, provided the mixture satisfies the requirements for the fine aggregates here in above specified. But not more than one part of the sand obtained by crushing natural stone may be added to two parts of washed sand.
- iii. The maximum size of coarse aggregate shall not exceed one-fifth of the smallest member size, three fourth of the smallest reinforcing bar spacing and three-

forth of the concrete cover. The maximum size of coarse aggregate shall not exceed 20 or 25mm for ordinary members, 40mm for large-cross section members, and 40 mm or one-fourth of the smallest dimensions of the member.

### **c) Reinforcement Steel**

Reinforcement steel is pivotal in providing tensile strength to concrete structures, essential for enduring loads and enhancing durability. Adherence to Japanese Industrial Standards (JIS) is crucial for ensuring the quality and integrity of construction projects. Here's a condensed guide on managing reinforcement steel within these parameters.

Specifications and Sourcing:

- i. Grades: Use deformed bars conforming to JIS G 3112 and mild steel bars per JIS G 3101, selecting grades based on the structural demand.
- ii. Quality Control: Obtain steel from certified sources, ensuring each batch is accompanied by test certificates aligning with JIS requirements for mechanical and chemical properties.

Handling and Fabrication

- i. Storage: Protect steel from corrosion by storing it on elevated platforms and organizing it by size and grade for easy access and contamination prevention.
- ii. Fabrication: Cut and bend reinforcement according to JIS G 3112, ensuring accuracy to design specifications with minimal tolerance.

Placement and Protection

- i. Installation: Securely place and tie reinforcement as per design drawings, maintaining required overlap, cover, and spacing as per JIS standards to safeguard against corrosion and ensure structural integrity.
- ii. Inspection: Conduct thorough pre-placement inspections to confirm alignment with structural designs and standards. Regular testing should be performed to validate the reinforcement's tensile and yield strengths.

**d) Water**

Samples of cement to be used in the works shall be deposited with the Project Manager for his approval together with a certificate stating the name and address of the Manufacturer, the name and address of the supplier from whom it was purchased. The Project Manager may from time to time take samples of the cement being used in the works for testing.

### 3.4 Concrete Grades and Mix Design

- i. **General Composition:** Concrete shall be composed of specified materials, ensuring optimal workability and durability. Mixes must be cohesive to avoid segregation, tailored for efficient placement and compaction.
- ii. **Workability:** Adjustments for concrete's workability, particularly for pumpability, must conform to Japanese construction standards, considering environmental impacts and specific site conditions.
- iii. **Concrete Grades:** Grades shall be determined based on structural requirements, environmental exposure, and specific project needs, ensuring compatibility with Japanese standards for civil and structural engineering.

#### **Mix Design:**

- i. **Materials Selection:** All materials, including cement, aggregates, and admixtures, must meet the quality standards specified in JIS.
- ii. **Water-Cement Ratio:** To be optimized for durability and strength, adhering to JIS recommendations.
- iii. **Admixtures:** Use is subject to approval, ensuring no adverse effects on concrete's durability or reinforcement corrosion potential, adhering to JIS guidelines.
- iv. **Aggregates:** Must be clean, durable, and properly graded to achieve dense concrete with the specified workability and strength, as per JIS standards.
- v. **Trial Mixes:** Necessary to confirm the mix design meets the specified performance criteria, with adjustments made as required for compliance with JIS.
- vi. **Documentation and Approval:** The contractor is responsible for submitting the mix design for approval, demonstrating compliance with Japanese standards and project specifications.

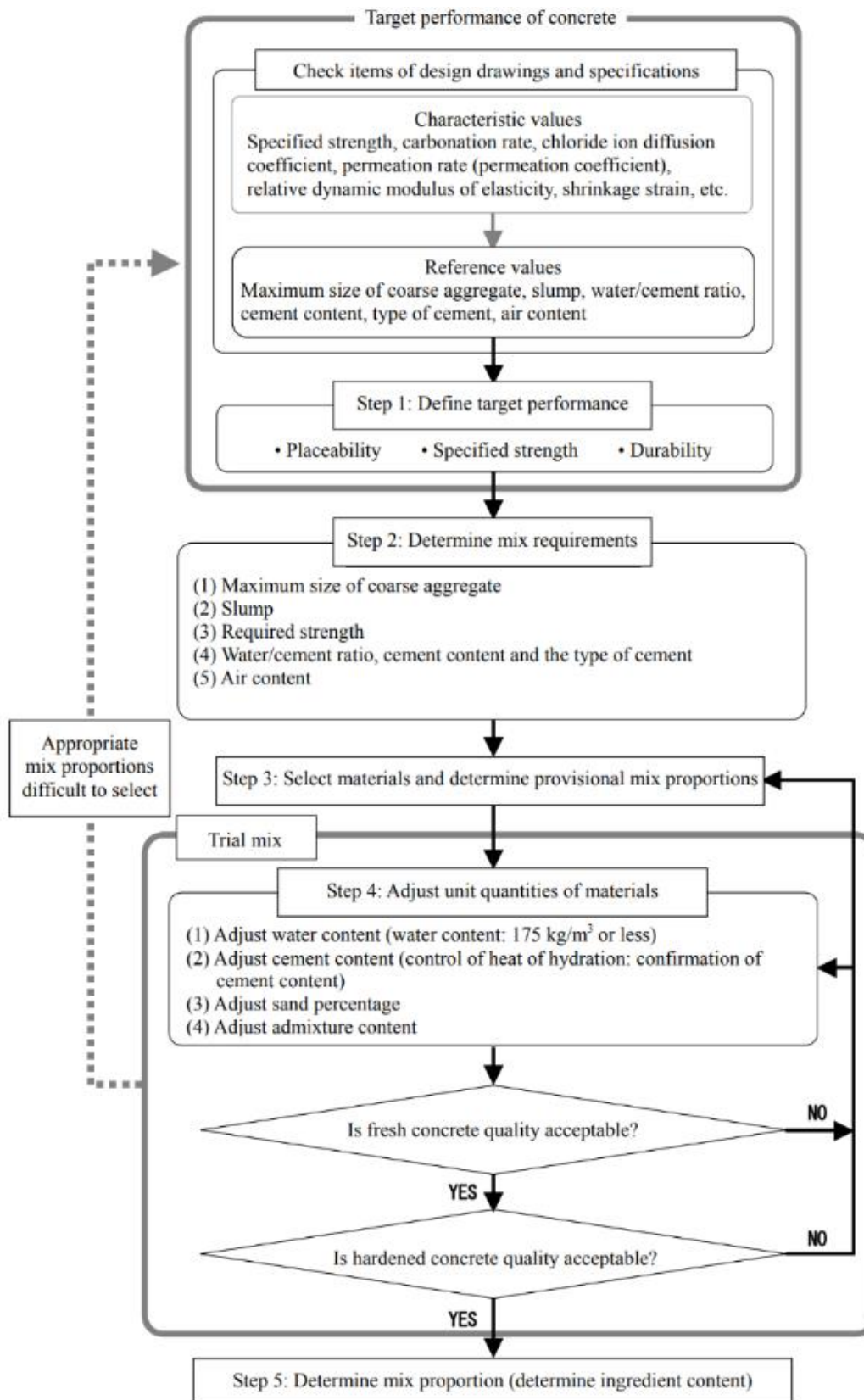

Figure 1: Concrete Mix Design workflow (Ref. JGC16\_Standard\_Specifications\_Materials\_and\_Construction)

Deterioration-causing environment	Maximum water/cement ratio (%)
When in contact with soil or water containing 0.2% or more sulfate (SO <sub>4</sub> )	50
When deicing agent is used	45

Note: If verification can be made by using past project data, research results, etc., a value of 5 to 10 may be added to the values shown above.

Figure 2: Water cement ratio (Ref. JGC16\_Standard\_Specifications\_Materials\_and\_Construction)

### 3.5 Batching and Mixing

- i. Only controlled design mix will be used for concrete. At the mix design stage, the target slump at the unloading location and the target slump upon completion of mixing shall be determined on the basis of the minimum slump for placement, taking into account transportation time, waiting time at the construction site and the decrease in slump due to on-site transportation. In trial mixing conducted in the form of laboratory testing, therefore, it is necessary to make repeated corrections for mix proportions to achieve the target slump at the unloading location or the target slump upon completion of mixing until the required minimum slump for placement can be attained, taking into account the decreases in slump not only immediately after completion of mixing but also after the passage of time. Concerning mix proportion corrections, Japanese standard should be used as a guide. As a rule of thumb, it may be assumed that slump retention time in a mixer test is about 30 minutes longer than that in a laboratory test.
- ii. Mixed concrete and subsequent changes in quality are greatly affected. Mixers used in laboratory testing, therefore, should be of the same type as the mixers used for construction. Trial mixing in a laboratory test should be conducted at constant temperature conditions (20±2°C). If the time of year when trial mixing is conducted differs from the time of year when construction is carried out and a considerable difference in placing temperature is expected, mix proportions need to be determined taking into account that temperature difference. It is also good practice to conduct trial mixing by using mixers and correct mix proportions derived through laboratory testing.
- iii. Concrete shall be provided with workability suitable for construction tasks such as hauling, placing, compacting and finishing according to the construction requirements, structural requirements and the environmental conditions. In concrete mix tests, it is important to check whether the mix proportions specified at the mix design stage have the targeted performance with respect to filling ability, pumpability, setting properties and strength development characteristics.

### 3.6 Transporting Concrete

In cases where ready-mixed concrete is used, the provisions of JIS A 5308 regarding transportation shall be used. JIS A 5308, As a general rule, the process from mixing to unloading be completed within 1.5 hours. it is recommended that the transportation from the plant to the construction site be completed in about one hour.



### 3.7 Concrete placement

- i) Concrete shall be placed carefully so that neither the reinforcing bars nor the formwork move out of position.
- ii) Placed concrete shall not be moved laterally in the formwork.
- iii) If severe segregation is identified during the placement of concrete, the placement shall be stopped, and a method for reducing segregation shall be determined and implemented.
- iv) Except at planned construction joints, the placement of concrete shall be carried out continuously until the placement is completed.
- v) As a rule, concrete should be placed so that the surface of the newly placed concrete becomes nearly horizontal. The standard lift height for concrete placement shall not be greater than 0.4 to 0.5 m in view of the performance of the internal vibrators used.
- vi) If concrete is placed in two or more layers, placement shall be carried out so that an overlying layer becomes integral with an underlying layer. The area of each concreting zone, concrete supply capacity, allowable placement interval, etc., shall be determined so that cold joints do not result. The term "allowable placement interval" is the time after completion of the placement and compaction of the underlying layer of concrete until the overlying layer of concrete is placed after a period of standing time. Standard allowable placement intervals are shown in following image. When a new layer of concrete is placed on a previously placed layer, vibrators shall be inserted into the underlying layer, too, for compaction accordance with Japanese standards.

Temperature in the environment	Allowable time lag between two placing lifts
Over 25°C	2.0 hours
25°C or less	2.5 hours

*Figure 3: Concrete placement time and temperature (Ref. JGC16\_Standard\_Specifications\_Materials\_and\_Construction)*

- vii) When placing concrete into high formwork, the inlet shall be positioned in the formwork, or the discharge location of the vertical chute or pipe shall be lowered close to the surface. In such cases, the distance of the surface of placing from the outlet of the chute, pipe, bucket, hopper, or other devices, should, in principle, not exceed 1.5m.
- viii) In cases when bleeding water appears at the surface during the placement of concrete, the water shall be removed using appropriate methods, before placing more concrete.
- ix) The standard rate of placement under normal conditions is about 1 to 1.5 m per 30 minutes. It is desirable, however, that adjustments should be made according to the size of the cross section, concrete mix proportions, compaction methods, etc.
- x) If the concrete of a slab or beam is continuous with the concrete of a wall or column, it is a standard requirement that the placement of the concrete of the slab or beam should be started after the settlement of the concrete of the wall or column has largely ended in order to prevent settlement cracking.

- xi) In cases when concrete is to be placed directly onto the ground, a layer of levelling concrete should be placed beforehand.

### 3.8 Quality Control

- i. To ensure the integrity and performance of the floating foundation, it's critical to maintain the quality of materials and mix proportions appropriate for the required concrete grade. Regular sampling and testing will be conducted throughout the construction process to uphold these standards.
- ii. The contractor is required to perform daily assessments of the moisture content and mechanical analysis of the fine and coarse aggregates during concreting activities, as stipulated by the project management's representative. These assessments ensure that the materials conform to the defined limits, guaranteeing the foundation's stability and durability in accordance with JASS 5 (Japanese Architectural Standard Specification) for concrete works.
- iii. Workability tests will be administered in compliance with JIS A 1108 (Method of Test for Compressive Strength of Concrete), ensuring that the concrete's workability aligns with the pre-approved mix design. The frequency of these tests will be adjusted to consistently achieve the desired workability levels.
- iv. Concrete sampling will be conducted randomly yet systematically as per JIS A 1108 standards, focusing on the deposition points of the concrete to ascertain uniformity and quality across the entire floating foundation.
- v. In addition to routine tests, the contractor will undertake additional sampling upon the project manager's request. All testing, including the test cube procedure, will adhere to JIS A 1108 requirements to ensure comprehensive quality assurance.
- vi. Standard Curing

Daily mean temperature	Ordinary portland cement	Blended cement B	High-early-strength cement
More than 15°C	5days	7days	3days
More than 10°C	7days	9days	4days
More than 5°C	9days	12days	5days

Figure 4: Standard curing duration (Ref. JGC16\_Standard\_Specifications\_Materials\_and\_Construction)

### 3.9 Construction joints

Construction joints shall be provided in the position described on the drawings or elsewhere and where not so described on the drawings or else shall be in accordance with the following:

- i. Concrete in a haunch or a splay on beam or a brace, and in the head of a column where one or more beams meet, shall be placed without a joint at the same time as that in the beam or beams or brace.
- ii. Concrete in the splay at the junction of a wall and slab shall be placed throughout without a joint, but if the provision of a joint is unavoidable, the joint shall be vertical and the middle of a span.
- iii. A joint in a slab shall be vertical and parallel to the principal reinforcement, where it is unavoidable, at the right angles to the principal reinforcement, the joint shall be vertical and at the middle of the span.
- iv. Expansion joints, hinges or other permanent structural joints shall be provided in the positions and of the form described in the drawings or elsewhere. Before placing new concrete against concrete that has already hardened the face of old concrete shall be cleaned and roughened and scrubbed and loose aggregate removed from the form. Immediately before placing the new concrete the face shall be thoroughly wetted and a coating of neat cement grout applied thereto. The new concrete shall be well rammed against the prepared face before the grout sets.

### 3.10 Form Work and scaffolding / Staging :-

- i) **Submission and Approval of Formwork Plans:** Before initiating concrete placement, the contractor is obligated to submit comprehensive drawings of the formwork (cantering and shuttering) for approval by the Project Manager. This submission must occur well in advance to ensure a methodical and scientific approach is employed in concreting, achieving uniformity in finish with minimal need for plastering. Any work deemed defective must be dismantled, redone, and the site cleared of debris.
- ii) **Construction of Formwork:** Formwork shall be engineered to facilitate the optimal placement and compaction of concrete, designed for robustness and to prevent excessive deflection under the loads of wet concrete, worker movement, and equipment, in compliance with Japanese Standard for Formworks. It must provide adequate support and alignment to maintain precise dimensions and shapes as per the finished concrete requirements.
- iii) **Formwork Rigidity and Watertightness:** To maintain rigidity and shape during concrete casting, formwork must ensure adjacent surfaces are smooth and within a tolerance of  $\pm 5$ mm. It must be sufficiently sealed to prevent loss of concrete mix water. Prior to concrete placement, formwork shall be cleaned and treated with a mold release agent, approved by the Project Manager, to facilitate easy removal without disturbing the reinforcement or concrete.
- iv) **Beam and Scaffold Requirements:** Around the building's perimeter, the contractor shall erect scaffolding at no extra cost, employing structural steel braced to support all anticipated loads. This includes safety measures such as netting and temporary railings for secure access to the building's exterior at all levels, evolving in tandem with construction progress.

- v) Removal of Form work (Striking Time)
  - (a) Formwork and shoring shall not be removed until the concrete has achieved sufficient strength to carry its own weight and any loads superimposed during the course of further construction.
  - (b) The timing and sequence of the removal shall be determined taking the strength of concrete, the structure type and importance, member types and dimensions, loads imposed on all members, temperature, weather and ventilation, etc. into appropriate consideration.
  - (c) In cases when the structure is subjected to loads immediately after the removal of formwork and shoring, the concrete strength, the structure type, and the characteristic and value of imposed loads shall be carefully considered in order to avoid harmful cracks and other damage to the structure.

### 3.11 Reinforcement Fabrication

- i. Reinforcing bars shall be fabricated to the shape and size specified in the design documents using methods that do not cause any damage. As a general rule, bars that have been bent once should not be re-bent.
- ii. Epoxy resin-coated reinforcing bars shall be processed by an appropriate method suitable for their characteristics.
- iii. As a general rule, reinforcing bars shall not be welded. If reinforcing bars are welded for a compelling reason and welded reinforcing bars are bent, the welded portions of the bars shall not be bent. Generally, bending should not be done within a distance calculated as 10 times the bar diameter.
- iv. If the bend radius requirements for reinforcing bars are not indicated in the design drawings and the specifications, reinforcing bars shall not be bent with a radius smaller than the inside bend radius indicated in the Design section of this Specification.
- v. Reinforcing bars should be fabricated at a normal temperature.

## 4.0 WATER PROOFING

### 4.1 General

- i. The objective of these specifications is to achieve a completely watertight environment for basements, toilets, terraces, and related areas, with a warranty period of no less than 5 years from the project's final completion date. This warranty obligation rests solely with the Contractor and not the waterproofing agency. The Contractor is responsible for supplying all necessary materials, labor, equipment, and any incidentals required to ensure a thoroughly waterproofed structure as specified herein.
- ii. Waterproofing efforts must be conducted by specialized contractors who have received approval. Both the installation process and materials should adhere to industry-best practices and manufacturer recommendations to ensure optimal waterproofing efficacy. Preparation is key to successful waterproofing; hence, work shall commence only on surfaces that are smooth, rendered, and cleaned of all dirt, dust, and foreign materials. These surfaces must be inspected and approved before waterproofing begins, with compressed air utilized to achieve effective surface cleaning. Any vents or protrusions through the roof must be fully secured prior to the application of flashing.
- iii. Technical specifications for the waterproofing shall be detailed by the selected specialized vendor. All specifications must receive approval from structural consultants before the initiation of any waterproofing work, ensuring that the methods employed are suitable for the unique requirements of floating foundations and comply with Japanese standards. Moreover, technical supervision by the parent company of the waterproofing contractor is mandatory throughout the entire execution period of the waterproofing system, at all levels, to guarantee the integrity and effectiveness of the waterproofing measures implemented.
- iv. This approach ensures adherence to both the functional requirements and the stringent standards set forth by Japanese regulations like [Guideline for Grass Fiber Reinforced Unsaturated Polyester Waterproofing Membrane Work - 2010, Guideline for Polymer-modified Cement Waterproofing Membrane Work – 2006, Technical Recommendation for Insulation Waterproofing Membrane of Heat Storage Tank – 2013, Japanese Architectural Standard Specification JASS 8 Waterproofing and Sealing - 2014], thereby securing the longevity and durability of the waterproofing system integral to the structure's foundation.

#### **Foundation:** Coal Tar Epoxy Waterproofing Application Method

##### 1. Surface Preparation:

- a. Clean and dry surfaces thoroughly, removing oil, grease, and loose materials.
- b. Use light grit blasting for optimal coating adhesion.
- c. Apply biocide post-blasting for algae and fungi removal.
- d. Repair any damaged concrete and smooth out with polymer-modified mortar.

2. Priming: While optional, a brushed-on coat of coal tar epoxy can enhance surface readiness, filling minor cracks.
  
3. Mixing: Mix three parts hardeners to one part base until uniform. Let stand for 4-5 minutes before application to reduce air entrapment.
  
4. Application: Apply two undiluted coats with a nylon brush, allowing 10-15 hours of drying between coats. Ensure full dryness before applying the second coat to avoid blistering.
  
5. Cleanup:
  - a. Clean tools with mineral turpentine immediately after use.
  - b. Ensure all preparations and applications adhere strictly to the product's technical specifications for the best results.

## 5.0 WATER TANKS (UG/STP)

- i. For the project's duration, water tanks will be either precast concrete or movable polymer models, chosen for their ease of installation, durability, and compliance with Japanese standards [JIS A 5373] for temporary structures. For underground water tank resting over foundation or closer to foundation following parameters needed to be taken care of:
- ii. Soil Assessment: Conduct soil assessments to determine the bearing capacity of the site. This information is crucial for the placement of heavy tanks and for ensuring that the soil can support the additional weight without excessive settlement or compaction.
- iii. Tank Placement: It should be as per pre-decided place only. Placement should be made after project manager's approval on soil assessment.
- iv. Spreader Plates or Beams: Use spreader plates or beams under the tank support points to distribute the load over a larger area of the foundation, reducing pressure on any single point and preventing damage to the floating foundation.
- v. Waterproofing: Ensure that the area around underground tanks is properly waterproofed to prevent water ingress into the foundation, which could weaken the structure or cause uneven settlement
- vi. Emergency Overflow Solutions: Include emergency overflow solutions that direct water away from the foundation in case of overfilling, preventing water accumulation that could undermine the foundation.
- vii. Drainage Considerations: For underground tanks, incorporate adequate drainage around the tank to manage groundwater levels and prevent hydrostatic pressure buildup against the tank walls and foundation.
- viii. Monitoring During Construction: Implement continuous monitoring of the foundation and surrounding structures during the tank installation process. Use instruments to measure any movements or shifts in the foundation, allowing for immediate corrective actions if needed.
- ix. Concrete shall not be mixed, placed, compacted or finished during the hours of darkness, except where necessary to complete a pour. However, concreting in darkness for these exceptions shall be only after obtaining the express permission in writing from the Architect's/Project Manager's representative and in his presence only.

## 6.0 PREAMBLE TO specifications

### 6.1 General

- i. These specifications, along with the contract conditions and drawings, constitute an integral part of the project documentation. They should be read comprehensively and in conjunction with each other, ensuring that all aspects of the project are covered without unnecessary repetition. While these specifications aim to be thorough, they are tailored to meet the specific needs of this project, which employs a floating foundation approach, in adherence to Japanese construction standards and practices.
- ii. In cases of ambiguity among the General Specifications, the Bill of Quantities, and contract drawings, such issues must be promptly referred to the Project Manager for resolution, ideally no later than ten days before the tender submission deadline. Any post-contract ambiguities will also be addressed by the Project Manager, whose decisions will be final. Claims for additional costs based on such ambiguities will not be considered.
- iii. Despite the division of these specifications under various headings, each section is intended to complement and supplement the others, ensuring a holistic approach to project implementation. References to Japanese Industrial Standards (JIS), Japanese Architectural Standard Specifications (JASS), and other relevant Japanese regulations as approved by the Project Manager. These references include the most current editions and all amendments up to the date of the tender invitation.
- iv. The Contractor is required to maintain on-site copies of all referenced standards, codes of practice, and guidelines, ensuring access to the most updated versions throughout the construction period.
- v. **Approved Manufacturers**
  - a) Specifications include a list of approved manufacturers to set a benchmark for quality. The reference to approved manufacturers aims to standardize quality rather than restrict competition. The Contractor is expected to factor in the cost of procuring materials from these approved sources or their approved equivalents into their pricing.
  - b) Materials must be delivered to the site in their original, unopened packaging, with the manufacturer's branding and identification clearly visible. Installation, mixing, application, and integration of these materials into the project must follow the manufacturer's printed instructions to the letter.
  - c) A construction date must be indicated on all relevant items to facilitate the monitoring of curing processes, adhering strictly to Japanese construction practices regarding concrete works and finishing. The Contractor must employ a pour card/checklist for all concrete and finishing tasks, adhering to prescribed formats and ensuring compliance with both the floating foundation approach and Japanese construction standards.

### 6.2 SITE DEVELOPMENT AND EARTH WORK

**The rates for all items under this section to include:**

- i. Excavation Measurement for Payment: Payment will be based solely on the plan dimensions of the bedding concrete (PCC under foundation) as per the structural drawings. Excavation for working space and slopes for soil stability will not be included in the payment scope.
- ii. Handling of Excavated Earth: Includes stacking within the site boundaries, with provisions for handling and rehandling as necessary.



- iii. Site Clearance: Removal of shrubs, brushwood, undergrowth, roots, and small trees with a girth not exceeding 30cm, measured at 1m above the ground level.
- iv. Work Setting Out: Establishment of work outlines, profiles, benchmarks, etc.
- v. Excavation Work: Execution of excavation, regardless of shape or slope, with adherence to specified or directed dimensions.
- vi. Safety Measures: Installation of adequate barriers, signage, lighting, and gangways across excavated areas and open trenches to ensure the safety of both workmen and the public, following guidelines set by the Japanese Association for Safety of Construction Sites.
- vii. Disposal of Excavated Material: Removal and disposal of spoil to prevent obstruction, as directed by the Project Manager.
- viii. Excavation Finishing: Trimming of all sides to achieve plumb and square edges, levelling bottoms, and clearing out slips and falls before concreting.
- ix. All-Conditions Work: Execution of work at varying depths and locations, as specified.
- x. Water Management: Removal of water accumulation in excavations due to any cause, employing methods compliant with Japanese environmental and safety regulations.
- xi. Support Structures: Provision of necessary shoring, strutting, and battening, with the contractor responsible for submitting methodology and design in accordance with JASS or JIS standards.
- xii. Anti-termite Treatment Guarantee: Provision of a signed guarantee for a minimum of ten years from project completion, in compliance with Japanese standards for anti-termite treatments.
- xiii. Soil Compaction Testing: Execution of laboratory or field tests to verify soil compaction, adhering to Japanese engineering practices.
- xiv. Compaction Measurement for Payment: Compacted volume of earth to be measured at the true location of filling/backfilling.
- xv. Ownership of Excavated Material: All excavated material to be considered property of the owner, unless specified otherwise.
- xvi. Mechanization of Basement Work: Utilization of mechanical means and equipment for excavation and disposal in basement areas.
- xvii. Final Levelling: Manual dressing to achieve final levels as directed by the structural engineer, ensuring compliance with JIS standards.
- xviii. Legal and Tax Compliance: Payment of royalties and other applicable taxes as required under Japanese law.
- xix. Structure/Construction Disposal: Dismantling and disposal of any existing structures or constructions within the excavation area.
- xx. Technical Specification Compliance: Adherence to all stipulations outlined in the technical specification, with a focus on integrating Japanese standards for the successful implementation of a floating foundation.

### 6.3 CONCRETE WORKS (PLAIN AND RCC)

The rates for all items under this section to include:

- i. **General Concrete Works Specifications:** All concrete works shall conform to JIS A 5308 (Ready-Mixed Concrete), ensuring characteristic strengths (28 days) at 20 N/mm<sup>2</sup>, 25 N/mm<sup>2</sup>, 30 N/mm<sup>2</sup>, and 35 N/mm<sup>2</sup>, as detailed in the project drawings. Specifications include requirements for mix designs, workability, and routine quality control tests at various construction phases. The rate includes costs for all materials, machinery usage, admixtures (subject to Project Manager approval), placement, compaction, formwork adjustments, embedding services, and curing, following JIS A 8603 (Guidelines for Concrete Curing) and JASS for floating foundation structures.
- ii. **Reinforcement Work Specifications:** In alignment with JIS G 3112 (Steel Bars for Concrete Reinforcement), the reinforcement works will include comprehensive handling, storage, preparation, and placement protocols. The quoted rates shall encompass all processes, including rust removal, bending, fixing, and providing spacers and cover blocks to ensure adequate concrete cover as per JIS standards. Reinforcement will be fabricated and placed according to JIS G 3109 (Steel Bars for Prestressed Concrete).
- iii. **Provisions for Openings and Embeddings:** Detailed protocols for integrating openings, pockets, and service conduits within concrete structures, ensuring seamless integration and functionality without compromising structural performance.
- iv. **Surface Finishes and Joint Work:** Guidelines for achieving desired surface textures on exposed concrete elements, construction joint treatments, and integration with existing structures are detailed, emphasizing aesthetic quality and structural coherence.
- v. **Reinforcement and Formwork Details:** Separate payment protocols for reinforcement by weight, including comprehensive detailing for formwork construction, ensuring precise alignments, levels, and surface finishes in accordance with JIS standards.
- vi. **Specialized Concrete Treatments and Tests:** Incorporation of grooves, molds, expansion joints, and ornamental works as per project requirements. Also includes stipulations for non-destructive testing and remediation of any identified defects, ensuring structural integrity.
- vii. **Mix Design and Quality Control:** Mix designs and material testing are to be conducted as per JIS standards, with additional requirements for pumpable concrete and water-retaining structures, emphasizing durability and performance.
- viii. **Comprehensive Specification Compliance:** The contractor is obliged to adhere to all outlined specifications and standards, ensuring the project's success through meticulous planning, execution, and quality assurance measures.

## 6.4 WATER PROOFING:

Waterproofing work shall be carried out by the specialise agency as approved by Architect/ Project Manager.

The rates for all items under this section to include:

- i. Cleaning, smooth rendering and preparation of surface for laying waterproofing, insulation and other treatments.
- ii. All cutting, trimming, dressing and waste.
- iii. Treatment of down take pipes, and other obstructions as shown.
- iv. Sealing all joints, corners, junctions of pipes and masonry/ concrete with epoxy putty.
- v. Curing/ wetting the surface at least for 10days and gunny bags to be spread wherever required before applicat of subsequent coat.
- vi. Work in narrow widths, junctions and at all locations as shown.
- vii. Work at all heights and depths.

## 7.0 IMPORTANT JAPANESE STANDARDS

*Table 1 - Important Japanese Standards Proposed to be followed*

1. Redundancy and Robustness in Building Structural Design, 2013
2. Introduction to Shock-Resistant Design of Buildings, 2015
3. Architectural Form and Mechanical Kansei, 2014
4. Recommendations for Loads on Buildings (2015), 2015
5. Guidebook of Recommendations for Loads on Buildings 1, 2016
6. Guidebook of Recommendations for Loads on Buildings 2 - Wind-induced response and load estimation/Practical guide of CFD for wind resistant design -, 2017
7. Recommendations for Design of Building Foundations, 2001
8. Recommended Procedures for Planning Soil Investigations for Design of Building Foundations, 2009
9. AIJ Recommendations for Design of Ground Improvement for Building Foundations, 2006
10. Evaluation of foundation soil for design and construction of building foundations, 2015
11. Recommendations for Designing of Small Buildings Foundations, 2008
12. Design Examples of Small Building Foundations, 2011
13. Standard for Structural Design of Timber Structures, 2006
14. Recommendation for Structural Calculation of Traditional Wood Buildings by Calculation of Response and Limit Strength, 2013
15. Design Manual for Engineered Timber Joints, 2009
16. Design Practice for Engineered Timber Joints, 2012
17. Fundamental Theory of Timber Engineering, 2010
18. Q&A for Designing Timber Shear wall Structures, 2011
19. Design Standard for Steel Structures -Based on Allowable Stress Concept-, 2005
20. Recommended Provisions for Seismic Damping Systems applied to Steel Structures, 2014
21. AIJ Recommendations for Plastic Design of Steel Structures, 2017
22. Stability Problems of Steel Structures 2013, 2013
23. AIJ Recommendations for Design of Connections in Steel Structures, 2012
24. AIJ Guidebook on Design and Fabrication of Column Base in Steel Structure, 2017
25. AIJ Guidebook on Design and Fabrication of Welded Connections, 2008
26. AIJ Guidebook on Design and Fabrication of High Strength Bolted Connections, 2016
27. Design Recommendations for Composite Constructions, 2010

28. Recommendations for the Design and Fabrication of Light Weight Steel Structures, 2002
29. AIJ Recommendations for the Design and Fabrication of Tubular Truss Structures in Steel, 2002
30. Recommendation for Limit State Design of Steel Structures, 2010
31. AIJ Recommendations for Fire Resistant Design of Steel Structures, 2017
32. Concept and Framework for the Structural Design of Steel Structures 1999
33. "Recommendations for Sustainable
34. Steel Building Construction (Draft) -Member Reuse-", 2015
35. Standard for Structural Calculation of Reinforced Concrete Structures, 2010
36. AIJ Standard for Lateral Load-carrying Capacity Calculation of Reinforced Concrete Structures (Draft), 2016
37. AIJ Guidelines for Seismic Design of Reinforced Concrete Foundation Members (Draft), 2017
38. Data for Structural Calculation of Reinforced Concrete Building, 2002
39. Guidelines for Performance Evaluation of Earthquake Resistant Reinforced Concrete Buildings (Draft), 2004
40. Behaviours and Design Method on Vertical Joint of Wall Panel Precast Concrete Structures, 1989
41. State-of-the-Art Report on High-Strength Concrete, 2009
42. Guidelines for Design and Fabrication of Diagonally Reinforced Concrete Members, 2010
43. Standard for Structural Design and Construction of Prestressed Concrete Structures, 1998
44. Recommendations for Design and Construction for Partially Prestressed Concrete (Class 3 of Prestressed Concrete) Structures, 2003
45. Guidelines for Structural Design and Construction of Prestressed Concrete Buildings Based on Performance Evaluation Concept (Draft), 2015
46. AIJ Standard for Structural Calculation of Steel Reinforced Concrete Structures - Based on Allowable Stress Concept and Lateral Load Carrying Capacity-, 2014
47. Recommendation for Detailing and Placing of Reinforcement on Steel Reinforced Concrete Structures, 2005
48. Design Standard for Composite Structures, 2014, 95p, 2,400
49. Guidebook on Design of Concrete Filled Steel Tubular Structures, 2012, 177p
50. AIJ Recommendation for Design of Latticed Shell Roof Structures, 2016
51. Damping and Response Control of Shell and Spatial Structures, 2008, 358p
52. Buckling and Strength of Latticed Shells, 2010, 382p

53. Recommendations for Design of Cable Structures, 1994
54. Guidebook for Numerical Analysis of Spatial Structures, 2017
55. DOME STRUCTURES IN JAPAN -RECENT ADVANCES IN STRUCTURAL ENGINEERING, 2004
56. Extreme Ground Motions and Seismic Performance Evaluation of Buildings - How to Prepare for Mega Subduction and Inland Earthquakes -, 2013
57. Seismic Loading-toward Performance-Based Design, 2008
58. Earthquake Ground Motion and Strong Motion Prediction -Key items for learning the basics-, 2016
59. Generation Guide for Seismic Input Motions Based on the Recent Advancement of Ground Motion Studies, 2009
60. Recommendation for the Design of Base Isolated Buildings, 2013
61. An Introduction to Dynamic Soil-Structure Interaction, 1996
62. Active and Seisactive Control for buildings -State of the Art-, 2006
63. Intelligible Guide to Structural Control, 2014
64. AIJ Recommendations for the Design and Construction of Ground Anchorages, 2018
65. Ground Anchorages Questions & Answers for Building Engineers, 2010
66. Recommendation for Design of KIGEN-TSUKI Buildings, 2013
67. Manual for Re-using Structural Members, 2009
68. AIJ Recommendations for of Earth Retaining for Excavation, 2017
69. Guidebook on Excavation Works Considering Neighboring Structures, 2015
70. Recommendation for Design and Construction Practice of Temporary Pier, 2014
71. AIJ Standard for Design and Calculation of Reinforced Concrete Boxed-shaped Wall Structures, 2015
72. AIJ Standards for Structural Design of Masonry Structures, 2006
73. Guideline for Reinforcement of Concrete and Masonry Box-shaped Wall Structures, 2013
74. Guidelines and Commentary to Seismic Evaluation for Concrete Masonry Garden Walls, 2014
75. Guidelines for Maintenance and Management of Structures in Nuclear Facilities, 2015
76. Protecting high-rises against long period motions - Wisdom to share among designers and engineers, 2013,
77. Structural Design Recommendation for Chimneys, 2007

*Note: The above list is suggestive and not exhaustive. Apart from these basic codes, any other related codes shall also be followed wherever required.*

**Note: The Code given are indicative however the contractor before procuring & executing the work shall ascertain & determine the applicable Japanese codes, which are required to be complied with Osaka Japan, and only there after the respective material should be used.**

## 4 Chapter D

### TECHNICAL specifications FOR PLUMBING & FIRE FIGHTING

#### 4.1 TECHNICAL REQUIREMENTS FOR PLUMBING & FIRE FIGHTING (FF) WORKS ABBREVIATIONS AND ACRONYMS

##### ORGANISATIONS

GSI	Geo Special information authority of Japan
AWWA	American Water Works Association
BSI	British Standard Institution
IEC	International Electrotechnical Commission
IEE	Institution of Electrical Engineers (of Great Britain)
ISO	International Standards Organisation
CHA	Central Housing Authority
CWA	Central Water Authority
DC	District Council
MC	Municipal Council
RDA	Road Development Authority
TMRSU	Traffic Management & Road Safety Unit
WMA	Wastewater Management Authority



## UNITS

A	Amp
°C	degrees Celsius
cm <sup>3</sup>	cubic centimetres
cm	centimetre
c/s	cycles per second
DB	decibels
gm	gram
Hz	Hertz
"	inch
in <sup>2</sup>	square inches
KA	kilo Amp
KVA	kilo Volt Amp
Kg	kilograms
Kgf	kilogram me force
Km	kilometer
KN	kilo Newton
Lb	pound (weight)
l/s	liter per second
m	Meter
mm	Millimeter
m <sup>2</sup>	square meter
m <sup>3</sup>	cubic meter
mm <sup>2</sup>	square millimeter
MAD	meters above datum

mg/l	milligram per liter
N	Newton
V	Volt
W	Watt
cm <sup>2</sup>	square centimeter

**OTHERS**

ABS	acrylonitrile butadiene styrene
AMSL	Above Mean Sea Level
AWG	American Wire Gauge
BSW	British Standard Whitworth
CP	Code of Practice (British)
DN	nominal diameter
GMS	galvanized mild steel
GRP	glass reinforced polyester
HV	high voltage
LV	low voltage
MDPE	medium density polyethylene
No	Number
NP	nominal pressure
OD	outside diameter
%	Percentage
PVC	polyvinylchloride (or unplasticized

	polyvinylchloride when applied to pipes)
SWA	single wire armoured
Exc	Exceeding
Ne	not exceeding

#### 4.2 EQUIPMENT & MATERIAL OF PLUMBING & FF SYSTEM

- i. The Plumbing System shall comprise of following Equipment's & Materials as specified in specifications.
  - a) Supplying and Fixing of Sanitary Fixtures and CP fittings.
  - b) Soil, Waste, Rain Water and Vent Pipes.
  - c) Water supply including Hot & Cold (Internal & External).
  - d) Pumps Room & allied works.
  - e) External Sewerage system.
  - f) Storm Water Drainage System.
- ii. The Fire Fighting System shall comprise of following Equipment's & Materials as specified in specifications.
  - a) Wet Riser System
  - b) Sprinklers System
  - c) Fire extinguishers
  - d) Gas Based Fire Suppression System

#### 4.3 GENERAL

- i. The special conditions of contract given below shall be read in conjunction with the other documents forming part of the contract. In case of any variance, these conditions shall supersede any other conditions mentioned in any contract document.
- ii. The materials, design and workmanship shall satisfy the specifications contained herein and codes referred to. Where the technical specifications stipulate the requirement in addition to those contained in the Standard Codes and specifications those additional requirements shall also be satisfied. In the absence of any Standard / Specifications covering any part of the work covered in this tender document, the instructions/directions of engineer-in-charge will be binding on the contractor.
- iii. All Plumbing & Fire Fighting installations shall be of high quality, complete and dully operational including all necessary items and accessories whether or not specified herein. All work shall be completed in accordance with the regulations and standard to the satisfaction of the Engineer-in-charge.

#### 4.4 EXECUTION OF WORK

- i. The work shall be carried out in conformity with the individual services drawings and within the requirements of Architectural, HVAC, Electrical, Structural and Other specialized services drawings.
- ii. The Contractor shall cooperate with all trades and agencies working on the site. He shall make provision for hangers, sleeves, structural openings and other requirements well in advance to prevent hold up of progress of the construction programmed.
- iii. On award of the work, Contractor shall submit a programmed of construction in the form of a PERT Chart or Bar Chart for approval of the Engineer-in- Charge. All dates and time schedule agreed upon should be strictly adhered to, within the stipulated time of completion/commissioning along with the specified phasing, if any.

#### 4.5 DRAWINGS

- i. All the drawings are diagrammatic but shall be followed as closely as actual construction permits. Any deviations made shall be in conformity with the Architectural and other services drawings.
- ii. Architectural drawings shall take precedence over Plumbing or other services drawings as to all dimensions.
- iii. Contractor shall verify all dimensions at site and bring to the notice of the Architects or Engineer-in-Charge all discrepancies or deviations noticed. Architects' decision shall be final.
- iv. Large size details and manufacturers dimensions for materials to be incorporated shall take precedence over small-scale drawings.
- v. All drawings supplied with the Tender shall be returned in good conditions along with the Tender.
- vi. All drawings/sketches issued by the Architects/Consultant for the works are the property of the Architects/Consultant and shall not be lent, reproduced or used on any works other than intended without the written permission of the Architects/Consultant.

#### 4.6 INSPECTION AND TESTING OF MATERIALS

- i. Contractor shall be required, if requested, to produce manufacturers Test Certificate for the particular batch of materials supplied to him. The tests carried out shall be as per the relevant International Standards.
- ii. For examination and testing of materials and works at the site Contractor shall provide all Testing and Gauging Equipment necessary but not limited to the followings: -

- a) Theodolite
  - b) Dumpy level
  - c) Steel tapes
  - d) Weighing machine
  - e) Plumb bobs, Spirit levels, Hammers
  - f) Micrometers
  - g) Thermometers, Stoves
  - h) Hydraulic test machine
  - i) Smoke test machine
- iii. All such equipment shall be tested for calibration at any approved laboratory, if required by the Engineer-in-Charge.
  - iv. All Testing Equipment shall be preferably located in special room meant for the purpose.

#### 4.7 METRIC CONVERSION

- i. All dimensions and sizes of materials and equipment given in the Tender document are commercial metric sizes.
- ii. Any weights, or sizes given in the Tender having changed due to metric conversion, the nearest equivalent sizes accepted by international (BS, ASTM etc.) Standards shall be acceptable without any additional cost.

#### 4.8 REFERENCE POINTS

- i. Contractor shall provide permanent Bench Marks, Flag Tops and other reference points for the proper execution of work and these shall be preserved till the end of the work.
- ii. All such reference points shall be in relation to the levels and locations given in the Architectural and Plumbing drawings.

#### 4.9 SHOP DRAWINGS

- i. The Contractor shall submit to the Engineer-in-Charge six copies of the shop drawings.
- ii. Shop drawings shall be submitted under following conditions: -
  - a. Contractor shall prepare shop drawings of complete scope of work for the entire building within four weeks of the award of work. These drawings shall be submitted to the Engineer-in-Charge for approval and the work shall be executed at site on the basis of these approved drawings.
  - b. Large scale drawings showing typical details for Toilets & Fixtures.
  - c. Equipment layout, piping and wiring diagram.
  - d. Structural supports/hanging/laying and jointing details for all types of pipes as required.

- e. Layout plans as required and for any changes in the layout of Plumbing / firefighting Architectural Drawings.

#### 4.10 AS BUILT DRAWINGS

- i. The Contractor shall maintain one as built copy of all Drawings, Specifications, Addenda variations, approved submittals, correspondence, and transmittals at the site in good order and readily available to the Owner and the Engineer-in-Charge. The As built Drawings shall be clearly and correctly marked and as built specifications annotated by the Contractor to show all changes made during the construction process at the time the changed Work is installed. No such changes shall be made in the Work unless previously authorized by the change order or by specific approval of deviations or revisions in submittals.
- ii. The Contractor shall prepare and furnish to the Architect / services consultant accurate as built drawings. Architect / Services consultant shall approve these drawings after due verification at site. After approval, the contractor shall submit to Engineer-in-Charge, A1 size three (3) black line white paper prints as well as soft copy in form of CD of each drawing as part of close out documents. Project manager shall forward the same to the owner for their records and for maintenance and operation.
- iii. The as built drawings must have the following information:
- iv. The works as executed complete with:
  - a. Run of all piping & diameters on all floors and vertical stacks.
  - b. Ground and invert levels of all drainage pipes together with location of all manholes and connections up to out fall.
  - c. Run of all water supply lines with diameters, locations, of Control Valves, Access Panels.
  - d. Location of all Mechanical equipment with whole plant layout, piping connections and panels as erected.
  - e. Details of supports left in place and locations of all services encountered.
  - f. Complete schematic diagram of the installation, as installed.
  - g. Hot water system layout and Schematic of the system

#### 4.11 CONTRACTORS RATES

- i. Rates quoted in this Tender shall be inclusive of cost of materials, labour, supervision, erection, tools, plant, scaffolding, service connections, transport to site, taxes on works contract and all such expenses as may be necessary and required to completely do all the items of work and put them in a working condition.
- ii. Rates quoted are for all heights and depths required for this work.
- iii. All rates quoted are inclusive of cutting holes and chases in walls and floors and making good the same with cement mortar/concrete of appropriate mix and

strength as directed by Engineer-in-Charge. Contractor shall provide holes, sleeves and recesses in the concrete and masonry work as the work proceeds.

- iv. Rates quoted shall be inclusive of cost incurred in testing, commissioning of works and materials.

#### **4.12 TESTING**

- i. Piping and drainage works shall be tested as specified under the relevant clauses of the specifications.
- ii. Tests shall be performed in the presence of the Engineer-in-Charge/Consultant.
- iii. All materials and equipment found defective shall be replaced and whole work tested to meet the requirements of the specifications.
- iv. Contractor shall perform all such tests as may be necessary and required by the local authorities to meet Municipal or other bye-laws in force.
- v. Contractor shall provide all labour, equipment and materials for the performance of the tests.
- vi. Contractor shall afford all the expenses for the offsite testing of material and equipment's.

#### **4.13 SITE CLEARANCE AND CLEANUP**

- i. The Contractor shall, from time to time clear away all debris and excess materials accumulated at the site.
- ii. After the Fixtures, equipment and appliances have been installed and commissioned, Contractor shall clean-up the same and remove all plaster, paints stains, stickers and other foreign matter of discoloration leaving the same in a ready to use condition.
- iii. On completion of all works, Contractor shall demolish all stores, remove all surplus materials and leave the site in a broom clean condition, failing which the same shall be done at Contractors risk and cost.

#### **4.14 LICENSE AND PERMITS**

- i. Contractor must hold a valid Plumbing license issued by the Municipal Authority or other competent authority under whose jurisdiction the work falls.
- ii. Contractor must keep constant liaison with all relevant authorities and shall be responsible for obtaining all approvals relating to water supply, sewerage, drainage and firefighting system. He shall also be responsible for co-ordination for getting the approval, with other agencies working on the project relating to their scope of work.

- iii. Contractor shall obtain No Objection Certificate before commencement of work, from the local authorities all related to his work as required for the building.
- iv. Contractor shall obtain, from the local authorities all related completion certificates with respect to his work as required for occupation of the building.
- v. All inspection fees or submission fees paid by the Contractor shall be reimbursed by the Owner on production of valid official receipts.

#### **4.15 CUTTING & MAKING GOOD**

No structural member shall be chased or cut without the written permission of the Engineer-in-Charge.

#### **4.16 MATERIALS**

- i. All materials used in the works shall conform to the Tender specifications.
- ii. As far as possible materials bearing B.S. certification marks shall be used with the approval of the Engineer-in-Charge.
- iii. Unless otherwise specified and expressly approved in writing by the Engineer-in-charge, materials of makes and specifications mentioned with Tender shall be used.

#### **4.17 SANITARY FIXTURES & FITTINGS**

##### **SCOPE OF WORK**

- i. Work under this section shall consist of furnishing all labor as necessary and required to completely install all Sanitary Fixtures, Brass and Chromium plated fittings and accessories as required by the drawings and specified hereinafter.
- ii. Without restricting to the generally of the foregoing the Sanitary Fixtures shall include all Sanitary Fixtures, C.P. fittings and Accessories etc. necessary and required for the building.
- iii. Whether specifically mentioned or not all fixtures and appliances shall be provided with all fixing devices, nuts, bolts, screws, hangers as required.
- iv. Testing of all fixture and fittings shall be as per applicable BS codes.

#### **4.18 GENERAL REQUIREMENTS**

- i. All Fixtures and fittings shall be provided with all such accessories as are required to complete the item in working condition whether specifically mentioned or not in the Drawing, Specifications and Drawings.
- ii. All Fixtures and accessories shall be fixed in accordance with a set pattern matching the tiles or interior finish as per Architectural/Interior designer's



requirements. Wherever necessary the fittings shall be centered to dimensions and pattern desired.

- iii. Fixing screws shall be half round head Chromium Plated brass with C.P. washers wherever required as per directions of Engineer-in-Charge.
- iv. All Fittings and Fixtures shall be fixed in a neat workman like manner true to Levels and Heights shows on the drawings and in accordance with the manufacturer's recommendations. Care shall be taken to fix all Inlet and Outlet Pipes at correct positions. Faulty locations shall be made good and any damage to the finished floor, tiling or terrace shall be made good at Contractors cost.
- v. When directed, Contractor shall install Fixtures and accessories in a mock-up room for the approval of the Engineer-in-Charge Sample room Fixtures may be reused on the works if undamaged, but no additional payment for fixing or dismantling shall be admissible.

#### 4.19 Supporting and Fixing Devices

The contractor shall provide all supporting and fixing devices necessary to install the sanitary fixtures and fittings securely in position. The fixing devices shall be rigidly anchored into the building structure. The devices shall be rust resistant and shall be so fixed that they do not present an unsightly look in the final assembly. Where the location demands, the Architects may instruct the contractor to provide chromium plated or other similarly finished fixing devices. In such circumstances the contractor shall arrange to supply fixing devices and install them complete with appropriate vibration isolating pads, washers and gaskets.

#### 4.20 Final Installation

- i. The contractor shall install all sanitary fixtures and fittings in their final position in accordance with approved trial assemblies and as shown on drawings. The installation shall be complete with all supply and waste connections. The connection between building piping system and the sanitary fixtures shall be through proper unions and flanged to facilitate removal/replacement of sanitary fixtures without disturbing the built-in piping system. All unions and flanges shall match in appearance with other exposed fittings.
- ii. Fixtures shall be mounted rigid, plumb and true to alignment. The outlets of water closet pans and similar appliances shall be examined to ensure that outlet ends are butting on the receiving pipes before making the joints. It shall be ensured that the receiving pipes are clear of obstruction. When fixtures are being mounted, attention shall be paid to the possibility of movement and settlement by other causes. Overflows shall be arranged as to give visible warning and discharge. A check shall be made to ensure that necessary anchoring devices have been provided for supporting water closets, wash basins, sinks and other appliances.

- iii. Joints/gaps between all sanitary appliances/fixtures and the floor/walls shall be caulked with an approved mildew resistant sealant, having antifungal properties, of color and shade to match that of the appliances/fixture and the floor/wall to the extent possible.

#### 4.21 Protection against Damage

The contractor shall take every precaution to protect all sanitary fixtures against damage, misuse, crazing, staining breakage and pilferage by providing proper wrapping and locking arrangement till the completion of the installation. At the time of handing over, the contractor shall clean, disinfect and polish all fixtures and fittings. Any fixtures and fittings found damaged, cracked chipped, stained or scratched shall be removed and new fixtures and fittings free from defects shall be installed at his own cost to complete the work.

#### 4.22 EUROPEAN W.C.

- i. European W.C. shall be wash down, single or double siphonic type, wall mounted set, flushed by means of exposed/concealed cistern as per as specified in Drawing. Flush pipe/bend shall be connected to the W.C. by means of suitable rubber adapter. Wall hung W.C. shall be supported by C.I. wall mounted chair.
- ii. Each W.C. seat shall be so fixed that it remains absolutely stationary in vertical position without falling down on the W.C.
- iii. Each W.C. shall be provided with 110mm dia (OD) flexible EVA body connector connecting the ceramic outlet of W.C.

#### 4.23 URINALS

- i. Urinals shall be flat back large white glazed Vitreous China of size as per specifications description.
- ii. Flat back Urinals shall be provided with 15 mm dia C.P. spreader, 32 mm dia C.P. domical waste and C.P. bottle trap with pipe and wall flange, and shall be fixed to wall by one C.I. bracket and two C.I. wall clips as recommended by manufacturers complete and as directed by Engineer-in-Charge.
- iii. Flat back urinals shall be fixed with C.P. screws and shall be provided with 32 mm dia Domical Waste leading to Urinal trap.
- iv. Urinals shall be flushed by means of sensor operated flush system.
- v. Waste pipes for urinals shall be of the following: UPVC Pipes
- vi. Waste pipes may be exposed on wall or concealed in chase as directed by the Engineer-in-Charge. Specifications for waste pipes shall be same as given in Sub Section.

#### 4.24 FLUSHING CISTERN

Flushing cistern shall be concealed type design for low volume dual flushes 3 Ltrs & 6 Ltrs as directed by Engineer-in-Charge or mentioned in the drawing.

#### 4.25 LAVATORY BASIN

- i. Lavatory Basins shall be white glazed vitreous china of size, shape and type as indicated in architectural drawings.
- ii. Each Basin shall be provided with MS. or C.I. brackets and clips and the basin securely fixed to wall. Placing of Basins over the brackets without proper securing and fixing shall not be accepted.
- iii. Each Basin shall be provided with 32mm dia C.P. waste with overflow, pop-up waste or rubber plug and chain, 32mm dia C.P. Brass Bottle Trap with C.P. pipe to wall and flange.
- iv. Each basin shall be provided with CP push type self-closing pillar tap or Single hole Mixing Fitting as mentioned in the drawing.
- v. Basins shall be fixed at proper heights as shown on architecture drawings. If height is not specified, the rim level shall be 79 cms above the floor or as directed by Engineer-in-Charge.

#### 4.26 SINKS

- i. Sinks shall be of stainless steel or any other material as specified in the architectural drawing.
- ii. Hand Wash Sinks and Process Sinks shall be of stainless steel.
- iii. Each sink shall be provided with M.S. or C.I. brackets and clips and securely fixed. Counter top sinks shall be fixed with suitable angle iron clips or brackets as recommended by the manufacturer. Each sink shall be provided with 40 mm dia C.P. waste with chain and plug or P.V.C. waste. Fixing shall be done as directed by Engineer-in-Charge.
- iv. Fittings for sinks shall be mixing fittings or as specified in the architectural drawing.

#### 4.27 ACCESSORIES

Accessories shall be of any of the following types:

##### **Towel rings**

Towel rail shall be C.P of size 150mm dia, and fixing with C.P brass brackets fixed to wooden cleats with C.P. brass screws.

##### **Toilet paper holder**

Toilet paper holder shall be of Satin finish stainless steel AISI 316 grade wall mounted type fixed to wooden cleats with C.P. brass screws.

### **Hand Dryer**

Hand dryer shall be of best quality, to be operated with 208 / 110 volts, single phase, with fully hygienic condition, with all accessories and fixing in the wall as mention in the Architectural drawing or as directed by Engineer-in-Charge.

### **Coat hooks**

Coat hooks shall be of satin finish stainless steel AISI 316 grade wall mounted coat hooks fixed to wooden cleats with C.P. screws or as directed by Engineer-in-Charge.

### **Soap dispensers**

Soap dispensers shall be of satin finish stainless steel AISI 316 grade wall mounted liquid soap dispenser with indicator having bottom trough of soap fixed to wooden cleats with C.P. screws or as directed by Engineer-in-Charge.

- i. Accessories shall be fixed with stainless steel half round head screws and cup washers in wall with rawl plugs or nylon sleeves and shall include cutting and making good.
- ii. Porcelain accessories shall be fixed in walls and set in cement mortar 1:2 (1 cement: 2 coarse sand) and fixed in relation to the tiling work. The flange of the recessed fixture shall cover the recess in the wall fully.
- iii. Contractor shall install all Chromium Plated and porcelain accessories as shown on the drawings or directed by Engineer-in-Charge.
- iv. All C.P. Accessories shall be fixed with C.P. brass half round head screws and cup washers in wall with rawl plugs or nylon sleeves and shall include cutting and making good as required or directed by Engineer-in-Charge.
- v. Porcelain accessories shall be fixed in walls and set in cement mortar 1:2 (1 cement: 2 coarse sand) and fixed in relation to the tiling work.

## **4.28 URINAL PARTITIONS**

- i. Urinal partitions shall be Glass partition suitable as per specifications item description.
- ii. Porcelain partitions shall be fixed at proper heights with C.P. brass bolts, anchor fasteners and M.S. clips as recommended by the manufacturer and directed by Engineer-in-Charge.

## **4.29 TOILET FOR THE DISABLED**

- i. Where specified, in washroom facilities designed to accommodate physically disabled, accessories shall be provided as per the BS Norms for Disable Persons architectural drawing or as directed by the Engineer-in-Charge.
- ii. Stainless steel grab bars of 600mm long suitable for expose mounting and penned non-slip gripping surface shall be provided in washroom for disabled

persons. The flushing cistern shall be provided with chromium plated long handles.

#### **4.30 TESTING AND ACCEPTANCE**

Sanitary fixtures and fitting testing shall be done as per Japan/BS standard guideline.

#### **4.31 INTERNAL DRAINAGE SOIL, WASTE & VENT PIPES**

##### **I. SCOPE OF WORK**

- i. Work under this section shall consist of furnishing all labor, materials, equipments and appliances necessary and required to completely install all soil, waste, vent and rainwater pipes as required by the drawings, specified hereinafter and as directed by the Engineer-in-Charge.
- ii. Without restricting to the generally of the foregoing, the soil, waste, vent and rainwater pipes system shall include the followings: -
  - a. Vertical and horizontal Soil, Waste and Vent Pipes, Rainwater Pipes and Fittings, Joints Clamps and connections to Fixtures.
  - b. Connection of pipes to Gully Traps & Manholes etc.
  - c. Floor and urinal traps, cleanout plugs, inlet fittings and rainwater heads as specified.
  - d. Waste pipes connections from all Fixtures e.g. wash basins, sinks, urinals and kitchen equipments.
  - e. Testing of all pipes.

##### **II. General Description**

In this Section "Goods" refers to pipes, valves and pipe fittings.

All goods to be supplied shall be suitable for sewerage purposes in the conditions prevailing in Japanese and particularly in the location of the works, for the conveyance of wastewater. All sewer pipes and fittings proposed shall be acceptable to the WMA.

##### **III. Scope of Work**

The Work within the scope of this Section comprises manufacture, testing at works as necessary, supply and delivery to a storage yard of pipes, valves and fittings in accordance with these specifications. The Contractor shall make his own arrangement for acquisition of storage area, access, fencing, storage cover, lighting and watching.

##### **IV. Order of Materials**

- i. Prior to placing any order for materials, the Contractor shall submit all relevant information for approval by the Engineer. The information shall include the list of materials, the supplier and origin, technical data on the quality and strength of the materials.

- ii. Notwithstanding the approval of order by the Engineer, any material found defective or unsuitable for incorporation into the Works shall be removed from the site.

#### **V. Periods for Delivery**

- i. In order to comply with the requirements of the installation programmed, the Contractor shall arrange his delivery programmed to meet the stage delivery periods stated in Programmed of Works.
- ii. The Contractor may be required to concentrate his earliest deliveries in order to meet the programmed for installation and due flexibility should therefore be allowed for in manufacturing.

#### **VI. Programme**

- i. The Contractor shall submit within **thirty (30) days** of the Engineer's Letter of Commencement, a programmed showing the various elements of design, manufacture and delivery in sufficient details to demonstrate that the periods of delivery stated above will be met.
- ii. The programmed shall also take due regard of the time required for drawing approval, testing and inspection at the works, freight and delivery to the specified storage area.

#### **VII. Approval of Drawings**

- i. The Contractor shall submit to the Engineer for approval within **thirty (30) days** of the Engineer's Letter of Commencement detailed drawings of the Goods and a general arrangement of a typical installation, including critical dimensions for associated civil works. They shall be accompanied, if required, by calculations and explanations to show that they comply with all requirements of these Specifications.
- ii. **Two (2) weeks** shall be allowed for approval by the Engineer following receipt of drawings.
- iii. Alteration to approved drawings shall only be made with the written consent of the Engineer.

#### **VIII. Operation and Maintenance Manuals**

**One (1) month** before the Goods are subjected to any commissioning tests, the Contractor shall supply to the Engineer a copy of the documents listed below. The copy shall be ring bound between stiff durable suitably titled covers with transparent pockets of adequate size for all the drawings. The information shall cover all

purchased and sub-contracted Goods in addition to the items manufactured by the Contractor.

- (a) Service schedule with fully detailed instructions and diagrams for operating, maintaining and servicing the Goods.
- (b) Fully detailed instructions and diagrams for stripping down the Goods for repairs and for reassembly.
- (c) Comprehensive parts list for all Goods with fully detailed instructions for re-ordering any component.
- (d) Set of record drawings including all amendments to the original approved drawings to show the Goods as finally commissioned.

**IX. Inspection and Testing at Works**

- i. Details of the type of manufacturing process shall be submitted for the Engineer's approval. Independently of the tests to be made on the constituent materials and on the Goods in accordance with the provisions of the Specification, the Engineer shall have the right to ask that factory checks be made concerning either the ways in which materials are used or on the manufacturing processes such as casting, founding, cooling, annealing, burring, welding, riveting, centrifuging, machining, drilling of flanges or any other process.
- ii. In this respect, the Contractor shall authorize the Engineer to carry out the corresponding inspections at the various stages of manufacture.
- iii. The Engineer reserves the right to inspect all or part of the stages of manufacture of components at any Sub-Contractors factory under the same conditions as those applied for inspection at the Contractor's factory.
- iv. All Goods shall be tested at works in accordance with the provisions of these Specifications.
- v. All Goods shall be subject to inspection prior to packing for shipment. Such inspection shall include visual inspection, compliance with the Specification, checking of test results as required by the Specification and appropriate Standard or other superior internationally recognized standard and witness testing as required. An inspection of packing and marking of all items may also be undertaken prior to shipment.
- vi. For all tests and inspections, the Contractor shall also provide the Engineer prior to dispatch with test and inspection certificates from an Independent Inspection Agency approved by the Engineer. The test and inspection certificates shall pertain to actual witness of test and physical inspection by the Agency on the particular consignment. Inspection by the Independent

Inspection Agency shall not, however, relieve the manufacturer of his responsibility to furnish material and perform work in accordance with these Specifications and the relevant Standards.

- vii. For the items tested, inspected and found to be satisfactory, an engineer's approval will be issued allowing the Contractor to proceed with arrangements to deliver the materials.
- viii. The Contractor shall furnish the Engineer with a manufacturer's certificate in respect of every consignment of the goods confirming that all items of goods comprising the consignment comply in all respects with the specified Standard. The original and **one (1) copy** of such manufacturer's certificate shall be delivered to the Engineer not later than **seven (7) days** prior to the intended date of delivery of the Goods to the storage area.

#### **X. Final Pre-Shipment Inspection**

All finished pipes shall be required to be visually examined and shall be free of injurious defects such as cracks, laminations and undercuts. The final pre-shipment inspection shall be attested by a certificate from the same Independent Inspection Agency responsible for carrying the test and inspection at the place of manufacture.

#### **XI. Marking**

Except where expressly agreed between the Contractor and the Engineer all components of the Goods shall be marked in a clear and lasting manner with the following information:

- a. symbol of factory where component was manufactured
- b. date of manufacture
- c. nominal diameter
- d. pressure class

#### **XII. Packing, Transportation and Handling**

- i. All materials shall be properly packed and stored safely. All sensitive materials such as gaskets etc. shall be fully protected by means of a moisture-excluding coating or a drying agent or a plastic sealant or plastic covers and/or wooden crates as appropriate to the approval of the Engineer.
- ii. The Contractor shall provide all necessary means of protecting the Goods during loading, transit, unloading and re-handling and delivery to the storage area. The measures adopted by the supplier at the port of shipment, at the port of unloading and for the transport to the site of work shall be to the approval of the Engineer. Likewise, the methods adopted by the civil works



Contractor on site will be subject to the approval of the Engineer. No unprotected hooks or wire slings will be permitted.

- iii. All packing shall be suitable for unpacking and repacking during inspection and for storing the Goods at the site in the open air or at the Contractor's storage area.
- iv. Transportation shall be affected in accordance with the Manufacturer's instructions. Vehicles used for transporting pipes shall have a body of adequate length so as not to occasion overhang and subsequent breakage of pipes. Nesting of pipes shall be permitted only in cases where there is no risk of damage to the interior lining. The Contractor shall be responsible for providing secure and adequate storage for all materials for use in the Works. Pipes shall be stacked clear of the ground and on timber supports spaced at such interval so as not to induce severe stress to the pipes. uPVC pipes and fittings shall be stored under cover free from direct sunlight.
- v. All spare parts which are ordered shall be delivered with the main order and shall be adequately labelled, protected and packed in a suitable container or containers complete with three (3) copies of a detailed inventory.
- vi. The Contractor shall supply all necessary materials and equipment for making good, where instructed by the Engineer, any damage to coatings of pipes, fittings and valves.
- vii. All materials shall be insured during shipment, delivery to site, storage, erection and the defect liability period.

### **XIII. Design**

- i. The Contractor shall design the Goods to comply with the duties stated in these Specifications, to the Engineer's satisfaction and in accordance with latest practice and it shall be such as will facilitate inspection, cleaning, maintenance and repair and ensure satisfactory operation under all conditions.
- ii. The general mechanical design of the Goods and particularly that of the seals, and other wearing parts, shall be governed by the need for long, trouble-free operation without frequent maintenance or attention being necessary.

### **XIV. Standards of Workmanship**

- i. The standard of workmanship shall be to the satisfaction of the Engineer and shall comply with the requirements of the Standards or Codes of Practice issued by any of the organizations referred to in clause 1.19.
- ii. The Contractor may propose other internationally recognized Codes of Practice or regulations equivalent to those specified for approval by the

Engineer. Such approval to these alternative Standards must be obtained prior to manufacture of and item to be supplied under this Contract. A copy of such alternative Standards shall be supplied in English to the Engineer when required.

**XV. Materials**

- i. All materials used in the manufacture of the Goods shall be approved by the Engineer.
- ii. All materials shall be new and of first-class quality, free from imperfections and selected for long life and minimum maintenance. Particular attention shall be paid to the prevention of corrosion either due to the proximity of dissimilar metals or due to severe ambient conditions. All parts shall be corrosion resistant or adequately protected against corrosion.
- iii. They shall have no modifying effect whatsoever on the physical, chemical, or bacteriological qualities of the raw water normally conveyed in the system under consideration, either by reason of the materials construction or leaching from protective coating and paint lining. All materials shall be such as have been proved under working conditions to be the most suitable for the purpose for which they are used.

**XVI. Reliability of Equipment**

The equipment shall be manufactured so as to ensure the highest standards of operational reliability. All items of equipment shall be long-lasting with a minimum of maintenance, and to meet the following conditions:

- i. They shall be suitable for the conveyance of sewage;
- ii. They shall be capable of withstanding all stresses that will be induced during handling, testing and operation without any damage;
- iii. They shall be watertight under all operating and testing pressures prescribed by the respective Standard;
- iv. They shall have long-term resistance to all external factors of the surrounding environment.

**XVII. Spare Parts and Special Tools**

- i. The Contractor shall submit with his tender a priced list of recommended spare parts and special tools sufficient in his estimation to cover five years operation of the Goods.

- ii. The items shall be considered as optional extras to the tender sum and the Engineer reserves the right to order none, part or the entire recommended list of spare parts and special tools.
- iii. All spare parts which are ordered shall be delivered with the main order and shall be strictly interchangeable with the corresponding parts of the Goods. They shall be packed and protected for storage at Site over long periods without deterioration due to adverse conditions. Sealed heavy gauge polythene packing, with included desiccants where necessary, or other approved methods shall be used. All parts shall bear clear indelible identification on the packing as to the contents, and each part shall be readily identifiable from an indelible label which shall be securely attached to each part.
- iv. The identification labels shall state the part number as well as the description of the item.
- v. A copy of a detailed schedule listing the items supplied together with their respective part numbers shall be submitted to the Engineer, at the same time that each batch of spares is handed over.
- vi. Any special tools necessary for dismantling, alignment, calibration, reassembly or maintenance of the Goods shall be included in the list.

## **XVIII. Pipes General**

### **A. Supply**

- i. Ductile Iron (DI) pipes, steel pipes, unplasticized polyvinyl chloride (uPVC) pipes, vitrified clay (VC) pipes and polyethylene (PE) pipes shall be to the diameters, lengths and classes indicated in the Bill of Quantities and the Specification.
- ii. The Contractor shall supply the following information for each nominal diameter of pipe:
  - a. External diameter
  - b. Internal diameter
  - c. Overall length per unit
  - d. Effective length per unit
  - e. Unit weight
  - f. Thickness
- iii. The Contractor shall state the method and conditions for loading, transportation, unloading and storage of pipes. Restrictions regarding temperature, humidity, orientation and the like shall be stated, if any, together

with the maximum number of pipe diameters that can be stocked vertically, for each diameter.

### **B. Marking**

Except where expressly agreed between the Contractor and the Engineer, all pipes shall be marked with the following information.

- a. symbol of factory
- b. date of manufacture
- c. nominal diameter
- d. pressure class / nominal stiffness class

The information shall be marked in a clear and long-lasting manner

## **XIX. Fittings General**

### **A. Supply**

- i. Pipe fittings shall be to the diameters and classes indicated in the Price Schedules and in accordance with the specified standards.
- ii. The Contractor shall supply the following information for each nominal diameter of fittings:
  - a. External diameter
  - b. Internal diameter
  - c. Overall length per unit, measured along the centre line
  - d. Coating and lining
  - e. Weight
  - f. Thickness
  - g. Type of joint.
- iii. The Contractor's shall state the conditions of storage required for all fittings. Restrictions regarding temperature, humidity, orientation etc. and the like shall be stated, if any.

### **B. Marking**

- i. Except where expressly agreed between the Contractor and the Engineer, all fittings shall be marked with the following information.
  - a. symbol of factory
  - b. date of manufacture
  - c. nominal diameter
  - d. pressure class / nominal stiffness class

- ii. The information shall be marked in a clear and long-lasting manner.

**XX. Ductile Pipes and Fittings for Use in Sewerage**

- i. Ductile iron pipes and fittings shall comply with the latest version of BS EN 598:2007 + A1:2009. Unless otherwise specified, they shall be supplied with flexible joints.
- ii. Rubber gaskets shall comply with the requirements of ISO 4633:2015.
- iii. Pipes and fittings for sewers shall be identified externally by a red color. They shall be supplied in standard lengths of 6m.
- iv. Flanged pipes shall comply with BS EN 545:2010. All flanges shall be supplied with a complete set of nuts, bolts and washers.
- v. The dimensions of socket and spigot pipes shall be as given in Table 11 of BS EN 598:2007.

**XXI. Unplasticized Polyvinyl Chloride (uPVC) Pipes and Fittings**

- i. Unplasticized “Non-Pressure” PVC pipes for sewers shall conform to the requirements of BS EN 13598-1:2010 or BS EN 1401-1:2009/ codes applicable in Japan. The nominal stiffness class of uPVC pipes and fittings to be used for the Works shall not be less than SN8.
- ii. Unplasticized “Pressure” PVC pipes and fittings where specified for sewers shall conform to the requirements of BS EN 1452 and BS EN ISO 1452/codes applicable in Japan respectively.

**XXII. Vitrified Clay Pipes**

- i. Vitrified Clay (VC) pipes shall be suitable for sewerage systems and shall conform to the requirements of BS 65 – “Vitrified Clay pipe fittings and joints, DIN 1230-clayware for drains and sewers or ASTM C 700 - vitrified clay pipe” and shall be provided with sockets or sleeve couplings.
- ii. The joints shall be flexible and of the compression ring push type. The rings shall satisfy the physical property and type test requirements of rings specified in BS EN 681-1:1996 and BS EN 681-2:2000
- iii. The pipes shall have the strength characteristics and shall not deviate from the nominal size beyond the limits of minimum and maximum shown.

**Table I-1: Characteristics of V.C Pipes**

<b>Nominal Diameter</b>	<b>Crushing Strength (KN/m)</b>	<b>Bore Diameter</b>	
		<b>Min</b>	<b>Max</b>
150	22	146	158
200	25	196	210
225	25	221	236
250	29	246	262
300	29	295	313

- iv. The selection of raw materials for the manufacture and manufacturing process shall be such as to achieve a low permeability in the finished pipe of less than 1 liter/mm pipe diameter/km length/day.

**XXIII. Centrifugally cast glass reinforced plastic pipes (cc-grp)**

- i. Non-pressure GRP pipes used under the Contract for the trunk sewers, in all cases, be manufactured using the centrifugally caste system. Filament wound GRP pipes will not be permitted. GRP pipes shall be used on the trunk sewers only and shall comply fully with the provisions of BS EN 14364:2013.
- ii. Non-pressure GRP pipes used in the Works shall have a minimum stiffness of SN10000.
- iii. GRP pipes shall be laid in accordance with the manufacturer’s recommendations. Rocker pipes shall be provided at each manhole position as shown on the drawings. Minimum lengths of rocker pipes shall be 0.5m but shall not be less than the pipe diameter.

**XXIV. High Density Polyethylene Pipes**

- i. High Density Polyethylene (HDPE) pipes if required for the Works shall be manufactured in accordance with BS EN 12201 and shall be able to sustain a nominal working pressure of ten (10) bars. Joints shall be of the quick joint or electrofusion types or through other approved mechanical coupling. Diameters specified are outside dimensions.

- ii. Suitable additives, such as soot shall be incorporated in the molding material to reduce the effect of ultra-violet radiation to the pipe material.
- iii. Each coil or batch of pipes shall be clearly stamped and numbered and the relevant pressure test certificate must accompany delivery. Coils may additionally be subjected to a similar test by the Engineer, and any failure may result in the rejection of the whole consignment.
- iv. The Engineer will require copies of the test certificates of the material from which the pipes are made to be submitted with the first deliveries. If approved, all subsequent deliveries shall be of a similar mixture and texture.

**XXV. manholes and Chambers**

- i. Manholes shall be constructed in accordance with the recommendations of BS EN 752: 2008, BS EN 476:2011 and BS EN 1917:2002. The invert of the manholes shall be of the same material as the sewer pipe. Alternatively, concrete with a granolithic finish shall be used. Sewer pipes shall be built into manholes as construction proceeds. The joints of the sewer pipes with the manholes shall be water-tight.
- ii. The benching shall rise vertically from the springing to at least 50 mm above the crown of the pipe, where it shall turn over with a nosing of about 25mm radius and rise at a gradient of about 1 in 30 to the wall of the chamber.
- iii. All manholes on sewers of diameter 600mm and above shall be provided with polypropylene hooks fixed to either side of the mouth of the outgoing sewer for fixing a safety chain when workers are at work. Handrails shall be provided on the edges of benchings, and at platforms, etc., to prevent falling into the sewer.
- iv. Precast concrete manholes and chambers shall be constructed in accordance with BS 5911.
- v. For deep manhole a corrosion resistant ladder should be provided including a guard cage for the safe entry and exit of the Manhole.

**XXVI. Manhole and Chamber Frames and Covers**

- i. Chamber frames and covers shall be of dimensions given below and approved to **BS EN 124**.
- ii. They shall generally conform to the following applications:

On streets and roads	Non-ventilated Heavy Duty Class D400 frame with water-tight cover, minimum clear opening 600 mm
On sidewalks and driveways	Non ventilated Medium Duty Class C250 frame with water-tight cover, minimum clear opening 600 mm
On washout and air valve chambers	Non-ventilated Medium Duty Class C250 frame with water-tight cover, minimum clear opening 600 mm.

**XXVII. Prefabricated Manholes**

- i. The Contractor may propose the use of pre-fabricated manholes in polyethylene or other approved material, where superimposed loads do not prevent the use of such manholes. The contractor should submit to the Engineer for his consideration details of benching, pipe rocket connections, and details of cover fixing. The Engineer may request for calculations showing structural stability of the finished manhole and cover assembly. Proposed prefabricated manholes should conform to the minimum dimensions as shown on drawings, but the Engineer may accept other dimensions acceptable to the Wastewater Management Authority.
- ii. The contractor may also propose the use of concrete pre-cast manholes, in which case the quality, dimensions and reinforcement etc. should conform to BS EN 1917:2002 and to all other specified details for in-situ concrete manholes. In addition, the contractor should submit for the Engineer’s approval all details of pre-casting, pre-casting yard, transportation and placement.
- iii. The Engineer may reject the use of any prefab or pre-cast manholes without assigning any reason thereto to the Contractor.
- iv. The Contractor may also build the manholes in approved pre-cast concrete rings surrounded by in-situ concrete 150 mm thick on an in-situ concrete upstand into which all incoming pipes have been built.
- v. Where precast concrete sections are used they shall be jointed with a elastomeric joint seal or other approved sealing material, with each joint carefully cleaned and flush pointed with 1:3 cement mortar. The joint configuration shall be “ogee” except for base sections immediately below the



cover slab, in these cases the contact joint shall be square with a key way through the middle of the joint.

- vi. The Contractor may propose manholes constructed with reinforced concrete cast in-situ or in brickwork, in which case he shall submit full design calculations and drawings for the Engineer's approval.
- vii. The invert of the manholes shall be formed in half precast concrete channels for connection into incoming and outgoing pipes and junctions as to obtain as smooth a transition as possible from one to the other. After the setting up of the half round channel sections, the benching of the manhole shall be completed to the details shown on the drawings. The benching shall be finished smooth with a steel float. On completion of all building operations, the channel invert shall be completely cleaned and made free from cement mortar.

**XXVIII. Step Irons**

- i. Steps for use in manholes and inspection chambers shall be plastic encapsulated to BS EN 13101: 2002 and shall be either of the following types:
- ii. Type C: Any shaped thread with patterned surface, without upstand; or
- iii. Type D: Any shaped thread with patterned surface, with upstand.

**XXIX. Gate Valves for Sewerage Works**

- i. Gate valves shall be installed either as pipeline isolating valves or at washouts. Valves will be double flanged with stainless steel or gunmetal spindles mounted vertically. They shall have a pressure rating of (ten) 10 bars, unless otherwise stated.
- ii. Stuffing boxes and glands shall be maintainable, repackable and replaceable without major dismantling of the valve.
- iii. Gate valves shall be designed so that any pockets where deposits could accumulate are self-cleaning.
- iv. Gate valves shall be of the inside non-rising spindle type, and shall be drop tight at design pressures under open and testing.
- v. The valve bodies shall be of cast iron. All bolts, nuts and screws shall be of stainless steel.

**XXX. Sluice Gates**

- i. Sluice gates shall be rectangular faced with a rectangular aperture offering an opening height of not less than the specified width and shall be channel mounted. The gate shall be simple in construction and offers direct operation by a hand wheel.
- ii. The frame and gate shall be constructed in high grade cast iron to BS EN 1561:2011 or in stainless steel to BS EN 10029. Operating stems shall be in stainless steel. Sealing faces shall be of copper alloy or approved polyethylene.
- iii. The unit shall be drop-tight. The contractor shall ensure that the frame does not get distorted during installation. Leakage through the seating shall not exceed 0.15 litre minute/m of seal perimeter (m).

**XXXI. Disc Flushing Valves**

- i. Disc flushing valves shall have circular apertures and be manufactured in high grade cast iron and designed for wall or flange mounting applications. The valves shall include a hooking mechanism to secure them in an open or intermediate position.
- ii. The sealing face shall be manufactured from copper alloy or approved polyethylene and shall be fixed securely into a machined recess.
- iii. The lifting handle and wall hook shall be in electro zinc plated mild steel or other approved resistant material and the pivot pin in stainless steel.

**XXXII. Air Relief Valves**

- i. Air relief valves for sewage applications shall be designed with a large float chamber capacity to isolate the sewage from the orifice and the sealing surfaces and to prevent blockages. Air valves shall be flanged mounted and be double acting or of double orifice pattern, providing bulk air release and inflow capabilities.
- ii. Air valve bodies and covers shall be of cast iron to BS EN1561:2011 or spheroidal graphite cast iron to BS EN 1563:2011 or approved material providing protection against aggressive service conditions.
- iii. All valves shall be flanged and supplied with an independent isolating valve or cock, which will enable overhauling or removal of air valves without disrupting waterflow in the pipeline.

**XXXIII. Flap Valves**

- i. Flap Valves shall be installed at washout outlets. Valves will be one side flanged and faced with horizontally mounted shafts. Valves shall open when flow occurs and close by flap self-weight, when flow stops.
- ii. Flap valve bodies and flaps shall be of high-grade cast iron.
- iii. Hinge pins shall be of chromium-nickel stainless steel and shall be so designed as to allow their replacement without removal of the valve body.
- iv. Sealings shall be of copper alloy or approved polyethylene and shall be maintainable, repackable and replaceable without major dismantling of the valves.
- v. Flap valves shall be designed so that any pockets where deposits could accumulate are self-cleaning, enabling drainage of all the water when washouts are opened.

**XXXIV. Check Valves**

- i. Check valves shall be double flanged free acting type specially designed for use in pumping sewage. The valves shall give rapid non-slam closure and low head characteristics when the door is in the open position. Check valves shall comply with the general requirements of BS EN 16767:2016 and suitable for a working pressure of (ten) 10 bars.
- ii. The valves shall have a cast iron body and door with gunmetal or nickel bronze alloy door seatings, and an access cover of adequate dimensions for removal of the door. The hinge pin shall be of stainless steel carried in non-corrodible bearings.

**XXXV. Pressure Surge Relief Valves**

- i. Pressure surge relief valves shall be installed on the pumping mains to relieve excess surge pressures in the pipeline.
- ii. Pressure relief valves casing shall be of high-grade cast iron or other approved metal coated by a fusion bonded epoxy unless otherwise specified to ensure protection against the aggressive service conditions. Unless otherwise specified, all other metallic parts, including bolts, nuts and screws shall be in stainless steel.

**XXXVI. ANTI-backflow / antiflooding valve**

Anti-backflow / Anti-flooding valve, if instructed by the Engineer, shall be installed just before Inspection Chamber A to prevent backflow from the main sewer and shall comply with the general requirements of BS EN 13564.

**XXXVII. Gullies**

- i. Plastic components in gullies shall comply with BS 4660: 2000 or BS EN 13598-1:2010. Other relevant standards may be applicable depending on the materials used for their construction. A sample gully along with technical specifications shall be submitted for approval prior to their inclusion in the works.
- ii. The gully shall incorporate a trap and a sump to retain detritus and shall be provided with a grating. The gullies should be fixed in such a way as to avoid debris and rain water from roof or floors from entering.

**XXXVIII. Sewer Construction - General**

- i. The requirements of this section shall apply to the construction of sewer lines.
- ii. The Contractor shall, as soon as the Works have commenced, prepare for his own use and guide an exhaustive list of materials needed for each section of the permanent Works so as not to be delayed through shortage of fittings.
- iii. He shall immediately inform the Engineer if he considers any discrepancy in the quantity of fittings between the drawings and the Bill of Quantities.
- iv. The Contractor shall satisfy the Engineer on the competence of the pipelayers prior to, and during pipelaying operations.

**XXXIX. Setting out**

- i. The wayleaves or other rights of way for pipelines will be defined by the Engineer across any private land and by the Engineer' /Representative across any land belonging to the Engineer or to the Government.
- ii. The Contractor shall, where required by the Engineer's Representative, set out the boundaries and shall provide, erect and maintain in position until final completion of the works 1.5-metre-high timbers, stakes or other approved members, indicating the said boundaries. Such stakes shall be provided at each and any change of direction of the boundary and at intervals not exceeding 100m and at such intermediate points as are deemed necessary by the Engineer's Representative.

- iii. The Contractor shall, in the presence of the Engineer's Representative, set out the pipeline alignments in accordance with the Drawings, making any change the Engineer's Representative may deem necessary. He shall also confirm the exact locations of all manholes, valves, air valves, washouts and hydrants, etc. The Contractor shall supply, install and maintain in position until trench excavation, marker posts at each and any change in direction of the pipeline and at intervals not exceeding 100m and at such intermediate points as are deemed necessary by the Engineer's Representative. Such markers shall be in the form of either concrete or steel or timber posts not less than 1.5 m high.
- iv. No work shall commence along any stretch of any pipeline until such time as ground levels and invert levels of existing manholes have been taken by the Contractor in an approved manner and checked and accepted by the Engineer, thereby ensuring that a firm record has been established for measurement and setting out purposes. Should the Contractor fail to comply with this clause, the Engineer shall base the final measurements on any other appropriate survey data.

**XL. Handling and Transport of Pipes and Fittings**

- i. The loading, unloading and handling of pipes and fittings shall be carried out using ropes, cranes, lifting beams and slings of approved design, strictly in accordance with the recommendations of the manufacturer and to the approval of the Engineer. Particular care shall be taken at all times to avoid damage of any kind.
- ii. The protective cover, discs, etc. provided by the manufacturer shall not be removed until immediately prior to installation.
- iii. When pipes are loaded for road transport, they shall be carefully handled to prevent damage. Pillows shall be provided between lashing (ropes, wires or chains, etc.) and the pipes. All cradles and lashings shall be of such widths as to prevent damage to the coating of the pipe, or distortion of the pipes.
- iv. In the event of any damage caused to the pipes and/or fittings, the Contractor shall be liable for the cost of all repairs or replacements and the costs of any delays. The Engineer shall determine whether the damage shall be repaired and in what manner. If repair is not approved by the Engineer, the Contractor shall forthwith replace the damaged unit.

**XLII. Stringing of Pipes**

- i. Pipes shall be placed on suitable pillows or other supports approved by the Engineer. End caps shall not be removed until such time as the pipe is to be inspected and laid.
- ii. At places where the pipeline route crosses roads, tracks or any other access and where approved by the Engineer, the Contractor shall deposit the pipes so that access by the public is in no way restricted.
- iii. The Contractor may be prohibited from using certain roads and tracks for the purpose of stringing on account of adverse weather conditions or restricted access; no extra cost incurred on this account or for any other road restriction, delay, or any other event which increases the cost of his haulage will be allowed.

**XLIII. Examination of Pipes and Fittings Prior to Laying**

Shortly before laying any pipe or fitting, the Contractor shall carefully examine each pipe and fitting to ascertain damage or defect. All damage and all defects revealed by this examination shall be repaired and remedied to the satisfaction of the Engineer's Representative.

**XLIV. Laying and Jointing of Pipes**

- i. Pipelaying shall be carried out only by experienced pipelayers.
- ii. Immediately before any pipe is lowered into the trench the plug shall be removed from the end of the last pipe laid and the new pipe shall be carefully lowered into the trench in an approved manner.
- iii. Each pipe and fitting shall be laid true to alignment and gradient in accordance with the Drawings or as directed by the Engineer's Representative.
- iv. Pipes shall be boned to gradient and sight rails shall be provided for this purpose at intervals not exceeding 20m with a minimum of three (3) sight rails along a pipe length to any one gradient.
- v. Pipes laid in trench shall have the minimum cover stated on the Drawings or as otherwise directed by the Engineer's Representative.
- vi. Pipes shall be laid and firmly bedded on an even and uniform bed. Where pipes are not laid on a granular bed, the bottom of the trench shall be smooth and free from stones or other projections. Pipes shall not be dragged along the trench bottom. Joint holes shall be excavated below the trench bottom and shall be as small as possible and shall be filled in and compacted after the pipes

are laid and before the refilling of the trench is commenced. Survey pegs in the trench bottom shall be removed.

- vii. Each type of joint shall be made in full compliance with the manufacturer's instructions. Pipe jointing shall only be carried out by experienced personnel and with close supervision by the Contractor.
- viii. The Contractor shall take all steps necessary to ensure that no extraneous matter is allowed to enter the pipes during or after laying. In the event of extraneous matter entering the pipes the Contractor shall immediately carry out the necessary cleaning as may be directed by the Engineer's Representative.
- ix. As pipe laying proceeds the Contractor shall ensure that pipelines are free from any obstruction by passing through the pipeline a 'badger' which shall be kept in the pipes at all times during construction of the pipelines. The 'badger' shall be pulled forward and any obstruction or dirt shall be removed immediately after the laying of each pipe and before the next one is placed in position, so that the barrel of the pipe is left perfectly clean at all times.
- x. The 'badger' shall consist of polyurethane foam with dimensions approved by the Engineer, with suitable attachments to allow for pulling through the pipes.
- xi. Except when necessary for jointing, the end of the last pipe laid shall be plugged to the satisfaction of the Engineer's Representative and the Contractor shall provide a sufficient number of plugs for this purpose.
- xii. Pipe trenches shall not be backfilled until permission to do so have been obtained from the Engineer's Representative. Subject to such permission being obtained, trenches shall be backfilled without delay.
- xiii. In case of replacement of an existing sewer pipe, necessary measures shall be taken to cater for all difficulties in removing existing pipes and sewer structures, carting away properly and dealing with incoming flows. The trench shall be kept safe from sewage contamination at all times.

#### **XLIV. Cutting of Pipes**

- i. Pipes shall be cut with an approved mechanical pipe cutter and in conformity with the pipe manufacturer's recommendations. The edges of the cut shall be clean, true and square.
- ii. The cut ends of pipes shall be chamfered and ground smooth or treated as recommended by the manufacturer prior to being jointed. Special tools

needed for this purpose shall be kept on site by the Contractor. Special care shall be taken not to damage the internal lining and the external coating of the pipe during cutting. Any such damage shall be made good according to the manufacturer's repair kit to the satisfaction of the Engineer.

**XLV. Proprietary Joints and Couplings**

- i. Proprietary joints and couplings shall be assembled in accordance with the manufacturer's instructions. The Contractor shall be responsible for obtaining such copies of the manufacturer's instructions at his own expense.
- ii. The Contractor shall be responsible for obtaining all the necessary special tools, lubricants and appliances necessary for making the joints. He shall also ensure the availability of any repair kit which shall be kept on the site of works at all times.

**XLVI. Granular Bedding to Pipes**

Granular bedding to pipes shall be 6mm single size aggregates. The material shall be evenly spread on a formation free of water and loose soil and shall be compacted and levelled to the underside of the pipe. After pipelaying, the material shall be brought up to half barrel of the pipe.

**XLVII. Concrete Surround to Pipes**

- i. Concrete protection to pipes shall consist of plain concrete bed and concrete surround as shown on the drawings and shall be of concrete Class 15 along such lengths as are shown on the Drawings or ordered by the Engineer.
- ii. In carrying out his work, the Contractor shall take care to pack the concrete under and around the pipes to ensure an even bedding and solidity of the concrete.
- iii. The concrete surround or haunching shall NOT be placed until the pipework has been inspected and approved by the Engineer. No backfilling shall commence until the completed concrete surround or haunching has been inspected and approved by the Engineer.
- iv. The concrete protection shall be placed across the full width of the trench and never less than 150mm wider on each side of the pipe barrel.
- v. When support of excavation is provided, building paper shall be placed against that support before concreting to facilitate withdrawal of the support.
- vi. In the case of spigot and socket pipes with flexible joints, the concrete protection at each joint shall be interrupted in a vertical plane at the edge of



the socket by a strip of fibreboard or other material approved by the Engineer and of the following thickness:

- |  |       |
|--|-------|
| a) Up to 300 mm nominal bore               | 13 mm |
| b) Over 300 and up to 600 mm nominal bore  | 25 mm |
| c) Over 600 and up to 1200 mm nominal bore | 38 mm |

**XLVIII. Flotation of Pipeline**

- i. The Contractor shall be solely responsible for ensuring that flotation of the pipeline does not occur during construction. The extent of the backfill placed over each pipe after laying and before testing shall be such as to prevent such flotation of the pipeline.
- ii. Should any section of the pipeline float out of line or level the section of pipeline so affected shall be removed and re-laid in accordance with the Specification to the satisfaction of the Engineer's Representative, and any damaged sections shall be discarded. The cost of the work and any pipe damaged and discarded through causes of flotation shall be borne by the Contractor.

**XLIX. Testing of Non-Pressure Pipeline**

- i. All non-pressure lines shall be subjected to a water test after backfilling. To satisfy himself on proper workmanship, the Contractor may carry out a preliminary test prior to backfilling.
- ii. Tests shall be carried out from one manhole to the other. The pipe length shall be plugged at its downstream end and filled with water. The upper end of the pipeline shall then be plugged with a stopper to which are connected a 90 degree bend through the centre and an outlet pipe fitted with an air release valve near the upper circumference. A length of pipe shall then be jointed to the bend at the centre and extended vertically outside the manhole and to a minimum height of 2.0 m above the pipeline. Water shall then be added through the extension pipe via a funnel until all air has been expelled from the pipeline. The air release valve shall be closed and the water level in the upstand pipe topped up for 30 minutes to compensate for absorption. After the initial 30 minutes, the level of water in the upstand pipe shall be maintained by adding measured quantities of water and noting the elapsed time.
- iii. The test line shall be considered to have passed such water test if the calculated loss of water is less than 1.2 litres per metre diameter per metre length of test line per hour or the amount given in the table below.

**Table I-2: Allowable Water Loss**

<b>Nominal Diameter mm</b>	<b>Pipe</b>	<b>Amount of water lost in 30 mins/100m of test line (litre)</b>
150		9.0
200		12.0
225		13.5
250		15.0
300		18.0

**L. Air Test for Sewer**

- i. Air test for pipes shall be carried out at the discretion of the Engineer and in accordance with BS EN 1610:1998. In such a case, the Contractor shall submit all details of the air test for the Engineer’s approval. Notwithstanding this provision, the Specifications described below shall apply.
- ii. The ends of the pipe run to be tested shall be closed by means of expandable plugs or other suitable type of plug which is air tight.
- iii. One of the plugs shall be provided with an entry pipe controlled by a stopcock. The entry pipe shall be connected to a manually operated air pump provided with a “U” tube manometer capable of reading up to 200 mm head of water.
- iv. Air shall be pumped into the system until the manometer is registering 100 mm head and this pressure shall be maintained for 15 minutes.
- v. The air pressure should not fall by more than 25 mm of water during a period of 5 minutes. If the loss of pressure is more than specified, the Contractor shall search for and repair the leak and then repeat the test. In the event that no source of leakage is discovered the Contractor shall carry out water test with such conditions as the Engineer may instruct. If the pipe run fails this water test the Contractor shall search for and repair the leak and then repeat the test.
- vi. The cost for such test should be borne by the Contractor.

**LI. TESTING OF MANHOLES**

- i. Completed manholes shall be subjected to a leak-proof test. The manhole shall be filled with water to the top of the cover level and left for 24 hours. After this period, the water in the manhole shall be restored to its original level. The manhole shall be considered as having passed the leak-proof test if after 30 minutes the level of water in the manhole has not dropped by more than 10mm.
- ii. The cost for such test should be borne by the Contractor.

**LII. Building of sewer**

The end of sewer lines at manholes shall be neatly cut flush with the inside wall of the manhole; the rubber ring joint shall be adjusted in place and the boxing filled with concrete; the Contractor shall ensure that no ingress of water occurs.

**LIII. Connection to Existing Manholes**

Connections of new sewer lines to existing manholes and chambers shall be carried out with care so as not to interrupt wastewater flow. The contractor shall, if necessary, provide pumping and other equipment to divert flow from the manhole when building in sewers or carrying out modification works.

**LIV. Cleansing of Pipelines**

- i. After the sewer lines have been completed and satisfactorily tested as herein specified, the Contractor shall flush out and cleanse the pipelines.
- ii. Sewer sections shall be cleansed by means of passing polyurethane foam swabs through the pipelines. The swabs shall be to the approval of the Engineer's Representative. Flushing shall be repeated until the discharge runs clean to the approval of the Engineer's Representative.
- iii. Swabs shall be passed through pipelines at speeds of between 0.2 and 0.4 metres per second to obtain the best cleaning results with the minimum number of passes.
- iv. The sewer lines shall then be flushed repeatedly until the discharge runs smoothly to the approval of the Engineer.

**LV. Testing of Outfall Sewer and Pressure Mains**

- i. All pressure lines shall be subjected to a water test after backfilling. The test pressure shall be the static pressure plus **five (5) bars**.
- ii. Before a length of pipeline is tested, each pipe shall be securely anchored. All thrust and anchor blocks shall have been constructed and, when the pipeline

is in trench, at least two thirds of the barrel of each pipe shall be covered with not less than 600mm of backfill material. Normally all joints shall be left exposed until pressure testing has been satisfactorily completed. Should circumstances make it necessary to backfill a pipeline completely before pressure testing is carried out, it shall be the Contractor's responsibility to excavate joint holes during pressure testing in the event that leaks have appeared during the pressure testing, which should require to be located.

- iii. Pressure testing shall be carried out as the work proceeds in such lengths of pipeline as are convenient and to the approval of the Engineer. The ends of the length of pipeline under test shall be closed by means of securely anchored caps or blank flanges. Pipeline sluice or butterfly valves shall not be used for this purpose. All washout valves shall be fitted with blank flanges and the valves opened before the commencement of any pressure test. At each air valve location, a special air release arrangement shall be provided to allow manual release of air during filling operations. Pressure testing shall not be carried out with permanent air valves in place.
- iv. The Contractor shall be solely responsible for the provision of all caps and blank flanges necessary for testing of the pipeline. The section of pipeline to be tested shall be filled slowly with water in such a manner that all air is expelled. Air valves or air vents shall be checked to ensure that no air is trapped at high points.
- v. The pressure in the pipeline shall be slowly raised to the test pressure, the test pump disconnected and the pipeline left charged under pressure with air valves in the operating position for a period of not less than 24 hours to allow air in the pipeline to be expelled. At the end of this period of time, the test pump shall be reconnected and the pressure in the pipeline raised again to the test pressure and this pressure maintained for a period of 4 hours or such other period as directed by the Engineer.
- vi. During the pressure test, all exposed joints shall be inspected and any leaking or seeping joints shall be remedied. Throughout this period, the pressure in the pipeline shall not be allowed to fall or rise by more than 6m head of water below or above the test pressure and this shall be accomplished by pumping water into or releasing water from the pipeline as required. The volume of water pumped into or released from the pipeline shall be carefully measured. At the end of the test period, the pressure in the pipeline shall be adjusted to the test pressure by pumping water into or releasing water from the pipeline as required.

- vii. The apparent leakage from the pipeline shall be ascertained from the net volume of water that has been pumped into the pipeline during the test period. This shall not exceed the volume determined by the following formula:

$$\text{Apparent allowable leakage} = \mathbf{K \cdot d \cdot L} \text{ liters per day}$$

i. **9000**

where,

**d = diameter of pipe in millimeters**

**L = length of pipeline under test in meters**

**K = 3**

- viii. All signs of leakage shall be remedied even though the total apparent leakage from the pipeline under test is less than the apparent allowable leakage.
- ix. Should any length of pipeline fail to pass the pressure test, the Contractor shall, at his own expense, provide all fittings and carry out all work necessary to locate and remedy the faults and to retest the pipeline until it satisfactorily passes the test.
- x. The use of air for testing is not normally acceptable. However, a low-pressure air test (not exceeding 0.3 bar) may be used for the purpose of detecting leakage in waterlogged ground, or as preliminary joint tightness test prior to backfilling.
- xi. The water used for pressure testing shall be provided by the Contractor, and shall be free from impurities and be of such a quality which will not pollute or injure pipelines, all to the satisfaction of the Engineer. The Contractor shall be solely responsible for making all arrangements for obtaining the water and transporting it and for the provision of all equipment labour and other things necessary for the test.

**LVI. Manhole Dimensions**

Manholes shall conform to the following minimum dimensions as indicated

**Table: Minimum Dimensions of Manhole**

<i>Depth to Invert (m)</i>	<i>Minimum Internal Dimensions (mm)</i>		<i>Minimum Cover Size (mm)</i>	
	Rectangular L X W	Circular Diameter	Rectangular L X W	Circular Diameter
1.5 or less	1200 X 750	1050	600 X 600	600
> 1.5	1200 X 750	1200	600 X 600	600

**LVII. Inspection chambers**

Inspection Chambers shall be either prefabricated or constructed in-situ in block work rendered internally, and shall have the minimum dimensions given

**Table: Minimum Dimensions of Inspection Chambers**

<i>Depth to Invert (m)</i>	<i>Minimum Internal Dimensions (mm)</i>		<i>Minimum Cover Size (mm)</i>	
	4.2 Rectangular L X W	4.3 Circular 4.4 Diameter	4.5 Rectangular L X W	4.6 Circular 4.7 Diameter
0.6 or less	450 X 600	450	450 X 600	450
1.0 or less	450 X 600	450	450 X 600	450

**LVIII. connecting new sewers to existing reticulation or structures**

- i. The Contractor shall inspect and determine the extent of work involved in connecting the new sewers to the existing reticulation or structures, and agree with the Engineer the procedure to be adopted for making the new connection in each case.
- ii. The Contractor shall provide all required labor and material for discontinuing flow in manholes and for over pumping as required. Payment thereof should be based on day-works rates.

- iii. When the Contractor has made all preparations in readiness for breaking into the existing reticulation or structures, he shall confirm to the Engineer in writing 24 hours in advance of proceeding with the work his intention to proceed with the connection.
- iv. The Contractor, when carrying out concrete work in such places as benching, backdrops and collars to pipework, shall use rapid hardening cement in all work covered under this clause and shall allow in his rates for any additional cost incurred.
- v. The Contractor shall be responsible for establishing the total flow of sewage to be pumped in order that sufficient pump capacity is made available for pumping the flow. If through any breakdown of pumping equipment, roads or streets become flooded and fouled with raw sewage, the Contractor will be held responsible for clearing and removing all soil and detritus that may have spilled from the manhole and deposited itself on the roads or streets. No surcharging of any manholes will be permitted while pumps are out of service and any blockage caused through such breakdown of pumping equipment will require to be rectified by the Contractor.
- vi. The Contractor must establish the total number of manholes that require to be plugged prior to commencement of interconnecting work.
- vii. The Contractor shall include in his rate for each individual manhole for the supply, laying and testing of all pipework including special fittings required for making the connection.

#### **LIX. REPLACEMENT OF WATER PIPES**

Laying or replacement of water pipes along with all ancillary works attached thereto, shall be carried out in accordance to the specifications and conditions laid by the CWA.

#### **LX. BUILDING AND ASSOCIATED WORKS**

##### **A. CEMENT MORTAR**

- i. Cement used for mortar, rendering, grout, screeding and other construction work shall be in accordance with the Specifications enclosed.
- ii. Cement mortar for blockwork, rendering, tiling and screeding shall consist of ordinary Portland cement and approved natural sand mixed by hand or approved mechanical mixer in the proportions by volume of one part cement to five parts sand unless otherwise specified or shown on the Drawings. The cement and sand shall first be mixed dry until the cement colour can no longer be distinguished from the sand in any part of the mass and the whole shall

then be uniformly wetted by approved means while undergoing further mixing. The water content shall just be sufficient to ensure mixing, and to ensure a dense mortar of stiff consistency and adequate workability to permit trowelling or floating into place. The workability of cement mortar to be used for rendering may be improved by adding an approved plasticizer in the proportions recommended by the supplier of the plasticizer, all to the approval of the Engineer.

- iii. Mortar shall be prepared and used as rapidly as possible after mixing. Under no circumstances shall any mortar be used that has stiffened through setting. Fresh mortar shall not be mixed with mortar prepared earlier and all batches shall be used separately.
- iv. Water used for cement mortar, rendering, screeding and other construction work shall be in accordance.

**B. BLOCKWORK**

- i. Precast concrete blocks for blockwork shall be solid blocks, ventilation blocks or hollow blocks manufactured from ordinary Portland cement and aggregates in accordance with the Specifications given and in accordance with BS EN 771-3:2011+A1:2015 or equivalent. Blocks shall be cured for a period of not less than ten (10) days. After curing, all blocks shall be grouped, carefully stacked and shall not be used for laying before 28 days after casting. All blocks shall be cast in clean molds of accurate shape and dimensions. The minimum compressive strength shall be 3.5N/mm<sup>2</sup>.
- ii. Blocks shall be in three basic sizes as shown

**Table:** Sizes of Blocks

<i>Basic Size</i>	<i>Co-ordinating Size</i>
200mm	400 x 200 x 200
150mm	400 x 200 x 150
100mm	400      200 x 100

- iii. All blocks shall be well soaked in water before use and the tops of walls where work has been left off shall be thoroughly wetted and raked back before work is recommenced. Blockwork shall be bonded in accordance with best constructional practice with vertical joints staggered. Where required for bond, blocks shall be carefully cut to size. No broken block or block of improper quality



shall be used. Blockwork shall be carried up regularly and no portion shall rise more than one (1) metre above adjacent portions, and at such changes in levels, work shall be stepped back. Courses shall be properly levelled and perpendicular joints, quoins, jambs and angles shall be plumbed as the work proceeds. No horizontal or vertical joint shall exceed 12mm thickness.

- iv. Any blockwork to be left unrendered shall be faced with selected blocks, built with a fair face and pointed with a neat flush joint. Any blockwork to be rendered shall have the joints raked out to a depth of 5mm to form an adequate key.
- v. Blockwork and concrete columns shall be bonded by approved galvanized metal ties cast into the concrete spaced at alternate courses and extending not less than 150mm into the block joints.

### C. RENDERING

- i. Rendering shall be carried out in a mix consisting of one part cement and four parts of sand gauged by dry volume unless otherwise directed. Rendering shall be in two coats of 15mm total thickness and shall be finished with a wood float.
- ii. The first coat, which shall have a thickness of 12mm, shall be roughened to provide an adequate key for the second coat.
- iii. Surfaces to receive rendering shall be thoroughly cleaned. Concrete surfaces shall be roughened either by hand or by wire brushing after removing the formwork, whilst the concrete is still green to form an adequate key; alternatively, the concrete surface can be treated with an approved cement bonding agent in accordance with the manufacturer's recommendation. In all cases, the surfaces shall be well hacked to form a good key. The joints of block or stone walls shall be raked. All surfaces shall be dampened as necessary and the rendering applied immediately afterwards.
- iv. The finishing coat shall be applied with a proper skimming float and thereafter trimmed with a feather edge rule to a true and even surface. Any unevenness shall then be thoroughly scoured with a hand float and filled in. Overworking of the surface shall be avoided to reduce the tendency of surface crazing.
- v. All rendering shall be protected from the sun and rain by adequate and suitable coverings and the rendering shall be kept damp while setting. Any cracks or parts which sound hollow when sounded with a light hammer or other defects in the rendering shall be cut out and re-rendered.

#### **D. TIMBER**

All timber for carpenter's and joiner's work shall be approved timber properly seasoned, straight cut, free from sap, warping, twist, shakes, large loose or dead knots etc. and shall be to the approval of the Engineer's Representative.

### **LXI. CATCHMENT AND ROAD DRAINAGE**

#### **A. General**

Section of these Specifications governs the construction of the following catchment and road drainage works:

- (a) Drains
- (b) Pipe and box culverts including head walls, wing walls, and cover slabs
- (c) Gullies and manholes
- (d) Retaining walls, paving slabs
- (e) Masonry works (including retaining walls, stone facing, rainwater downspout etc.
- (f) Riprap
- (g) Concrete channels
- (h) Masonry lined ditches
- (i) Unlined ditches

#### **B. Drainage Excavation**

- i. The Contractor shall excavate all catchment and/or roadside drainage systems to the lines, levels, gradients and dimensions shown on the Drawings or as directed by the Engineer.
- ii. Excavation for drainage systems shall be carried out in accordance with the requirements of Section – Excavations and Earthworks.
- iii. Should excavations be executed to greater depth or widths than necessary through the incidence of boulders or other causes, the Contractor shall backfill and make good, with approved materials thoroughly compacted, to the correct line, level and dimensions and to the approval of the Engineer.
- iv. The material excavated for drainage channels shall be, if suitable, set aside for use as backfill; if found unsuitable or in excess, the excavated material shall be carted away to spoil tips.

*Note: Excavation rates, as specified in the Bill of Quantities, should allow for such carting away.*

### **C. Timbering and Shoring of Excavations**

- i. The sides of excavations in trenches and pits shall, where required, be timbered and shored to the satisfaction of the Engineer. The Contractor shall remain liable for any damage or injury to his workers and the public arising from his failure to provide timbering and shoring in any part of the works, irrespective of whether the Engineer has approved this stretch of the excavations or not. He shall in the same way be liable for premature removal of any shoring or timbering.
- ii. Where directed by the Engineer, the timbering and shoring shall be left in excavations and measured and paid for except if, in the Engineer's opinion, the necessity for leaving the shoring and timbering in the trenches has been the result of carelessness or neglect on the part of the Contractor.

### **D. Trenches and pits Excavation and Backfilling**

- i. The excavations of trenches and pits shall be of adequate and sufficient dimensions to enable the proper compaction of the bottom of the trench, the placing of the bedding material, the laying and placing of thrust concrete and the proper backfilling and ramming operations to be carried out.
- ii. Where deemed necessary, the bottom of such excavations shall be compacted as may be required.
- iii. Where rock is encountered at the formation level of the trench, it shall be cut to a depth of 200 mm below the formation level and replaced with sand, granular material or other material to the approval of the Engineer.
- iv. Trenches shall be kept free from water until any concrete works shall have sufficiently set; the Contractor shall construct any temporary drains for the purpose of keeping the trenches dry.
- v. Where seepage of water occurs in trenches or pits, bedding and backfilling shall be carried out using sand, granular material or crushed stones or other suitable material as directed by the Engineer.
- vi. Material for backfilling shall be deposited in layers not exceeding 150 mm of loose material, compacted with power rammers, the moisture content of the material being adjusted to facilitate thorough compaction. The density of each compacted layer shall not be less than that specified in the relevant British Standard.

#### **E. Masonry Lined Ditches**

Lined ditches whether of trapezoidal, rectangular or square or V-Sections shall be built in masonry to the cross-section as shown on the drawing or as directed by the Engineer, and the invert level shall be finished to a steady longitudinal gradient not less than 0.5% and the fall shall be in all cases towards a culvert. The drain shall be lined with stone facing which shall comply with the relevant sections of these Specifications.

#### **F. Unlined Ditches**

- i. Unlined ditches whether of trapezoidal, rectangular or square or V-Sections shall be constructed to the cross-section as shown on the drawing or as directed by the Engineer.
- ii. The invert level shall be finished to a steady longitudinal gradient of not less than 1 % and the fall shall be in all cases towards a culvert.

#### **G. Pipe Culverts**

- i. Care should be taken to clean the inside of the pipes before any pipe culverts are put in place. Any damaged or cracked pipe shall not be used.
- ii. Pipes shall be embedded in Class 15 concrete to the lines and level shown on the drawings.
- iii. The methodology used for the placing of the pipes, the joints to be used as well as the tools being employed, shall be to the approval of the Engineer.
- iv. A properly fitted plug shall be placed inside the openings at the end of each pipe already laid and shall be removed only when the next pipe line is being laid or on completion of the pipeline or culvert.
- v. Backfilling shall be brought up evenly on both sides of the pipe. Special care shall be taken to compact thoroughly the material under the haunchings of the pipe and to ensure that backfilling material is in intimate contact with the pipe.
- vi. Jointed pipes shall be tested by an appropriate method or as directed by the Engineer.

#### **H. Box Culverts**

- i. Box culverts shall be built to the lines, levels and dimensions shown on the Drawings. The base shall rest on firm soil and if the nature of the soil encountered requires the foundation to be lowered, the extra depth excavated shall be filled up with Class 15 concrete. The bottom of the excavation shall be filled with Class 15 blinding concrete.

- ii. The invert of the box culvert shall be finished smooth to a steady gradient. The base slab and the cut-off walls shall be cast in Class 15 concrete.
- iii. The supporting walls and the wing walls shall be built with Class 15 concrete. All exposed surfaces shall have a smooth off-shutter finish and construction joints shall be rubbed down to a smooth finish. The contractor may consider the construction of the supporting walls and wing walls in masonry, subject to the approval of the Engineer.
- iv. The top of the supporting walls shall be finished smooth to a perfectly level surface (by a layer of concrete in the case of masonry walls) to provide a smooth fixation of the precast apron slabs.
- v. The apron slabs shall be cast in Class 30 Concrete and shall have a smooth off-shutter finish to the dimensions and levels given on the drawings. These slabs may be cast in-situ or precast at the option of the contractor and subject to the Engineer's approval. If they are precast, they shall, in all respects, comply with the requirements for precast concrete given in these Specifications.

#### **I. Gullies and Manholes**

Gullies and manholes shall be built to the lines, levels, dimensions and details given on the drawings. The bottom of the excavation shall be blinded with Class 15 concrete. The base slab and the walls shall be built with Class 25 concrete. The internal surfaces shall be of off-shutter finish with the construction joints rubbed down to produce a uniform and smooth surface. The top edge of the wall shall be carefully finished smooth and level to accommodate the precast cover slabs without any undue rocking movement.

#### **J. Masonry Works**

- i. The stones for masonry works shall be in accordance with the requirements of the relevant clauses of these Specifications.
- ii. The masonry shall be laid to line and in courses roughly levelled up. The bottom courses shall be composed of large selected stones and all courses shall be laid with bearing beds parallel to the natural beds of the material.
- iii. Each stone shall be cleaned and thoroughly saturated with water before being put in place and the receiving bed shall be cleaned and well wetted. All stones shall be well bedded in freshly placed mortar.
- iv. Wherever possible, the face joints shall be properly pointed before the mortar becomes set. Joints which cannot be so pointed shall be prepared for pointing by racking them out to a depth of 50 mm before the mortar has set.

- v. Vertical joints in each course shall be placed out of line relative to those of adjoining courses by at least 150 mm. In no circumstances shall a vertical joint be so located as to occur directly above or below another one.
- vi. In case any stone is moved or the joint broken, the stone shall be taken up, the mortar joint thoroughly cleaned, and the stone reset in fresh mortar.
- vii. Joints not pointed at the time the stone is laid shall be thoroughly wetted with clean water and filled with mortar. The mortar shall be well driven into the joints and finished with an approved pointing tool. The wall shall be kept wet while pointing is being done; in hot or dry weather, the pointed masonry shall be protected from the sun and kept wet for a period of at least four (4) days after completion. After the pointing is completed and the mortar has set, the wall shall be thoroughly cleaned and left in a neat condition.

#### **K. Riprap**

The stones for riprap shall be as specified in the relevant Clauses of these Specifications. They shall be laid with closed joints from the bottom of the slope of the embankment or existing ground, in an upward direction, with the larger stones being laid at the bottom.

#### **L. Rainwater Downspouts**

The stones for rainwater downspouts shall be as specified in the relevant clauses of these Specifications. They shall be laid and bedded in Class 15 concrete to the lines, levels and dimensions given in drawings.

#### **M. Concrete Channels**

- i. Concrete channels shall be constructed to the cross-section as shown on the drawings or as directed by the Engineer and the invert shall be finished smooth to a steady longitudinal gradient of not less than 0.5% and the fall shall in all cases be towards a culvert. The walls shall be of off-shutter quality finish with the construction joints rubbed down to a smooth finish. The top edge of the walls shall be carefully finished smooth and level so that the precast covers do not rock. Expansion joints filled with an approved bituminous compound shall be formed every 20 meters.
- ii. Blinding shall be of class 15 concrete and the base slab and the walls shall be of Class 25 concrete.

#### **N. Concrete Culverts**

- i. The base slab or footings of box culverts shall be placed and allowed to set before the remainder of the culvert is constructed.
- ii. Before concrete is placed in the sidewalls, the culvert footings shall be thoroughly cleaned of all shavings, sticks, sawdust, or other extraneous material and the surface carefully chipped and roughened.
- iii. The concrete in the walls shall be placed and allowed to set before the top slab is placed.
- iv. Each wing wall shall be constructed monolithically. Construction joints, where unavoidable, shall be horizontal and so located that no joint will be visible in the exposed face of the wing wall above the ground line.

#### **O. Concrete in Bridge Decks**

- i. Concrete incorporated in bridge decks shall be as per general requirements given in these Specifications, but it shall also include the following.
- ii. The concrete shall be uniformly levelled and screeded to produce a plain surface. When the concrete has sufficiently hardened to prevent laitance, it shall be floated to produce a uniform surface, free from screed marks and exposed aggregate. Finally, the surface shall be textured by brushing or otherwise to the waterproofing manufacturer's requirements as agreed by the Engineer. The accuracy of the finished surface shall be such that it does not deviate from the required profile by more than 10mm over a 3m gauge length or have any abrupt irregularities more than 3 mm.
- iii. The Contractor is required to submit all technical specifications of the waterproofing material for approval by the Engineer, prior to its inclusion in the Works.

### **LXII. ENVIRONMENTAL CONSIDERATIONS**

#### **A. General**

In addition to Clause 2.4, the following sub-clauses shall be considered among others to ensure that proper design strategies, construction methodologies and mitigation measures are adopted to minimize the environmental impacts.

**B. Community Relation**

The Contractor shall ensure that effective communication and consultation are established with the local community to minimize the likelihood of nuisances and complaints that may hinder the progress of the Works. Typical liaison may include:

- a. local residents and/or resident groups (force vive)
- b. representative of sensitive buildings (e.g. mosque, temple, school, community centre, health centre, etc.)
- c. any other national or local interest groups, etc.

**C. Protection of Surface Receiving Water**

The construction methodology of the Contractor must be established such that rivers and any other surface water features are neither obstructed by the Works nor contaminated by sewage or any other product which are to be used in the Works.

**D. Prevention of Odors and Toxic Gas**

The Contractor shall ensure that odors and toxic gases that may occur due to the septicity of raw sewage or from any of the processes involved in the Works, are catered for appropriately by providing mechanical ventilation or any other mitigation measure as may be required. At all times, the Contractor shall ensure proper safeguard his employees, third parties and the public in general from any hazardous situation that may arise due to the occurrence of toxic gases.

**E. Prevention of Noise and Vibration**

As far as technically possible, the Contractor must properly plan the timing of all works that are deemed to cause nuisance due to noise and vibration to the surrounding environment. The Contractor shall also ensure proper liaison with representative of sensitive buildings and activities (e.g. school, mosque, health centre, etc.) so as to avoid protests and situation arising thereof, that may hinder the Works.

**F. Prevention of Site Contamination**

The Contractor shall ensure in his construction methodology that necessary precautions are taken to deal with live sewer line and the raw sewage that it is conveying. The Contractor must also have a proper contingency plan to deal with



issues that may arise from damage to existing live sewer lines, so as to prevent site contamination as well as ensure safe and continuous operation of the live sewers.

**G. Dust Control**

The Contractor shall take necessary measures to mitigate disturbance due to airborne dust caused by the Works. These shall include, among others, of the following:

- a. All dust producing activities shall be damped down during dry weather and windy conditions.
- b. If possible, stockpiles shall be temporarily covered or properly sprinkled with water.
- c. Long-term stockpiles on site shall be avoided.
- d. Drop heights must be minimized to control the fall of materials.

**H. Environmental monitoring and Mitigation Plan**

The Contractor shall take all necessary measures to mitigate the environmental impact of this construction activities. An Environmental Monitoring and Mitigation Plan (EMMP) shall be put in place and submitted to the Engineer within 28 days of the Contract Start Date, by the Contractor and shall include, but not limited to the measures given in the following table:

**Table 7-3:** Environmental Mitigation Measures

<i>Area of Study</i>	<i>Potential Negative Impact</i>	<i>Mitigation Measures</i>
Construction Materials	Uncertain damage to marine ecology through use of coral sand	<ul style="list-style-type: none"> <li>• Use rocks sand as an alternative to coral sand wherever possible</li> </ul>
Air Quality	Dust Generation	<ul style="list-style-type: none"> <li>• Water sprinkling in dry weather</li> <li>• Cover stock piles of excavated materials</li> <li>• Maintain roads clear of mud and dirt from the site</li> </ul>

		<ul style="list-style-type: none"> <li>• Routine maintenance of construction vehicles</li> <li>• Switch off vehicles when not in use</li> <li>• Routing of vehicles away from major residential areas as much as possible</li> </ul>
Noise	Impact of residential properties	<ul style="list-style-type: none"> <li>• Restrict work to daylight hours and Monday to Saturday only</li> <li>• Use of properly tuned engines, proper mountings and muffing of equipment. Maximum allowable noise to be 65 decibels.</li> <li>• Monitor noise levels daily</li> <li>• Use of equipment fitted with silencers</li> <li>• Place noisy operations away from residences</li> <li>• Switch off equipment when not in use</li> <li>• Avoid rock blasting</li> <li>• Use of hydraulic equipment</li> <li>• Provide noise protection to workers</li> </ul>
Water Quality	River Crossings Waste disposal	<ul style="list-style-type: none"> <li>• Open cut method</li> <li>• Waste handling and disposal procedures</li> <li>• Prohibit unauthorised dumping of waste</li> <li>• Proper disposal of stormwater and excess water from trenches</li> <li>• Good site management practices to be put in place</li> </ul>

Land	Waste disposal	<ul style="list-style-type: none"> <li>• Same as above</li> </ul>
	Visual impacts	<ul style="list-style-type: none"> <li>• Construction work to be undertaken in segments</li> <li>• After completion of Works, areas shall be returned to near original condition</li> </ul>
Traffic	Impact on residents along roads Traffic congestion	<ul style="list-style-type: none"> <li>• Restrict work to daylight hours</li> <li>• Proper planning and coordination of traffic diversion routes</li> <li>• Limit length of open trenches</li> <li>• Inform public in advance of diversions</li> <li>• Avoid work during peak hours in areas of high traffic</li> <li>• Designate routes which minimise disturbance to residential areas</li> </ul>
	Vehicle emissions	<ul style="list-style-type: none"> <li>• Routine maintenance of vehicles</li> <li>• Switch off vehicles when not in use</li> <li>• Route vehicles away from major residential areas.</li> </ul>
Socio-economic	Noise	<ul style="list-style-type: none"> <li>• Same as in noise above</li> </ul>
	Traffic	<ul style="list-style-type: none"> <li>• Same as in traffic above</li> </ul>
	Access to properties	<ul style="list-style-type: none"> <li>• Proper vehicular</li> </ul>
	Damages to properties	<ul style="list-style-type: none"> <li>• Good construction practices to avoid property damage</li> <li>• Adequate compensation or repairs</li> </ul>
Health and safety	Workers Safety	<ul style="list-style-type: none"> <li>• Good site management practices</li> <li>• Trenches to be protected to prevent cave-in</li> </ul>

		<ul style="list-style-type: none"> <li>• Protective clothing to workers</li> <li>• Regular H&amp;S reviews on site</li> </ul>
	Public Safety	<ul style="list-style-type: none"> <li>• Boards indication construction activity shall be displayed</li> <li>• Dewatering of trenches and proper access to properties</li> <li>• Proper site supervision by Contractor</li> <li>• Adequate barriers at work places</li> </ul>

**LXIII. GENERAL REQUIREMENTS**

- i. All materials shall be new of the best quality conforming to specifications and subject to the approval of Engineer-in-Charge.
- ii. Soil, waste and vent pipes in shafts, ducts and in concealed areas i.e. (false ceiling) shall consist of UPVC conforming to BS/ASTM pipe & fittings.
- iii. Pipes and fittings shall be fixed truly vertical, horizontal or in slopes as required in a neat workmanlike manner.
- iv. Pipes shall be fixed in a manner as to provide easy accessibility for repair and maintenance and shall not cause obstruction in shafts, passages etc.
- v. Pipes shall be securely fixed to walls and ceilings by suitable clamps at intervals specified. Pipes shall as far as possible be kept 50mm clear of wall.
- vi. Access doors for fittings and cleanouts shall be so located that they are easily accessible for repair and maintenance.
- vii. Every waste pipe shall discharge above the grating of properly trapped gully. Contractor will ensure that this requirement is adequately met with. Wherever floor traps are provided it shall be ensured that at-least one washbasin/washing trough is connected to such floor traps to avoid drying of water seal in the trap.
- viii. All traps on branch soil and waste pipes shall also be ventilated at a point not less than 75mm or more than 300mm from their highest part and on the side nearest to the soil pipe or waste pipe.
- ix. All works shall be executed as directed by Engineer-in-Charge.

### A. Soil, Waste & Vent Pipes

- i. The Soil & Waste pipe system above ground has been planned as a "two pipe system" as defined in BS, having separate pipes for waste from kitchen sinks, showers, washbasins, AC condensate drains and floor drains. Waste stacks have been provided with a "P" trap at ground floor.
- ii. All waste water from A.C condensate will be provided with a deep seal trap before connecting to the main drain or vertical stack.
- iii. Vertical soil & waste stacks shall be connected to a common horizontal drain pipe at ground floor or to an external manhole directly wherever feasible as shown on the drawings.
- iv. All soil and waste from areas below general ground level (Basements) will be collected in sumps and pumped into sewer lines.
- v. All sprinklers drain from FHC connected to storm water lines.
- vi. Anti-siphonage pipe (ASP) shall be provided for soil fittings on vertical stacks. It may also be provided for waste lines where shown on the drawings.
- vii. Vent pipes shall be provided at all sewer lines at the starting manholes.

### B. Rainwater Pipes

- i. All terraces shall be drained by providing down-takes rainwater pipes.
- ii. A separate piped drainage system for slopping roof with leaders shall be provided.
- iii. Rainwater pipes are separate and independent connected to the external storm water drainage system as shown on the drawings.
- iv. Rainwater in enclosed courtyards shall be collected in catch-basins and connected to storm water drains.
- v. Any dry weather flow from waste appliances, AC condensate shall be connected to the sewerage system only.

### C. Planter drainage

Terraces, planters and formal landscape areas will be drained by a separate pipe connected to external storm water drainage system.

### D. UPVC pipe & fitting for soil, waste & rain water pipe

#### i. Clamps

- a. Holder bat clamps shall be of standard design fabricated from MS dip galvanized flats 40x3mm thick and 12mm dia MS rod and 6mm nuts and bolts; painted with two coats of black bitumen paint before fixing. The clamps shall be fixed in cement concrete 1:2:4 mix (1 cement: 2 sand: 4 stone aggregate 20mm nominal size) blocks 100x100x100mm deep.
- b. Where holder bat clamps are to be fixed in RCC column or slotted angles, walls or beam they shall be fixed with 40x3mm flat iron "U" type clamps with anchor fasteners of approved design.

- c. Structural clamps shall be fabricated from MS structural members e.g. rods, angles, channels, flats as per detailed drawing or as directed. Contractor shall provide all nuts, bolts, welding material and paint the clamps with one coat of red oxide and two or more coats of black enamel paint to give an even shade.
- d. Wherever MS clamps are required to be anchored directly to brick walls, concrete slabs, beams or columns, nothing extra shall be payable for clamping arrangement, RCC block and making good with cement concrete 1:2:4 mix (1 cement: 2 sand: 4 stone aggregate 20mm nominal size) as directed by the Engineer-in-Charge.
- e. For sleeves, anchor fasteners and clamp spacing chart shall be as follows:

**CLAMP AND PIPE SUPPORT SPACING OR AS PER BS STANDARD**

S.No.	Type of Pipes & Position	Commercial Pipe Dia. ( Spacing in m )						
		15/20	20/25	32/40	50	75/80	100/110	150/160
<b>1</b>	<b>Vertical Pipes</b>							
1.1	<b>GI /MS Pipes</b>	<b>2.4</b>	<b>2.4</b>	<b>3</b>		<b>3.6</b>	<b>4.5</b>	<b>5.4</b>
1.2	UPVC Pipes			<----- 1 m ----->				
1.3	UPVC Pipes	x	x					
1.3	uPVC /cPVC Pipes /Pex BS for Water Supply	x	x	x		<-----1 m----->		
	BS for SWR	x	x	0.5		0.7	0.9	0.9
<b>2</b>	<b>Horizontal Pipes</b>							
2.1	GI /MS Pipes	<-----2.0 m ----->		2.4 m	3	3.6	4	4.5
2.2	uPVC pipes							
	SWR Pipes			<----- 1.0 m ----->				
	Water Supply Pipes uPVC IS 4985					<-----1 m----->		
2.3	Fittings	All traps and tees and fittings runing below ceiling shall be supported on both sides						

**ii. Traps**

**a. Floor traps**

Floor traps shall be siphon type full bore P or S type upvc having a minimum 50 mm deep seal. The trap and main waste pipes in toilets having 150 mm sinking shall run below slab and shall be supported from the ceiling below. The trap and waste pipes in sunken area (where required) shall be set in cement concrete blocks firmly supported on the structural floor. The blocks shall be in 1 : 2 : 4 mix (1 cement :2 coarse sand :4 stone aggregate 20 mm nominal size) and extended to 40 mm below finished floor level. Contractor shall provide all necessary shuttering and centering for the blocks. Size of the block shall be 30x30 cms of the required depth.

**b. Urinal traps**

Urinal traps/horn shall be polypropylene P or S traps with or without vent shall be fixed as specified for floor traps.

**c. Floor trap inlet**

Bath room traps and connections shall ensure free and silent flow of discharging water. Where specified, Contractor shall provide a special type inlet fitting fabricated from UPVC pipe without, with one, two or three inlet sockets fixed on side to connect the waste pipe. Joint between waste and hopper inlet socket of the trap shall be joined with recommended by the manufacturer. Inlet shall be connected to a polypropylene P or S trap. Floor trap inlet hoppers and the traps if set in cement concrete blocks as specified in para above without extra charge. Polypropylene multi-inlet trap can be used where ever possible to be decided by the Engineer-in-Charge.

**iii. Trap & Seals**

All traps shall be self cleaning design and the seal depth shall be as specified below wherever the traps are not integral with the appliances:

<b>Appliance or ware</b>	<b>Material</b>	<b>Trap Type</b>	<b>Seal depth(mm)</b>
Lavatory /wash basin	C.P. cast brass	32 mm dia Bottle	75 mm
Sink	C.P. cast brass	40 mm dia Bottle	75 mm
Kitchen floor drain of fabricated drain boxes	uPVC	75/100 mm dia 'P' or 'S'	50 mm
Urinals	uPVC	100 mm dia 'P' or 'S'	50 mm
AC Condensate	uPVC	75 mm dia 'P' or 'S'	50 mm

**iv. Floor Gratings**

Floor and urinal traps shall be provided with 100-150mm square or round C.P./Stainless steel grating, with rim of approved design and shape. Minimum thickness shall be 4 mm.

**v. Jointing**

Pipe to pipe and pipe to fitting (SWR) joint shall be with 'O' rubber ring as recommended by the manufacturer. Jointing with solvent cement shall be applied to uPVC waste pipes (confirming to BS/ASTM) and fittings or as recommended by the manufacturer's.

**vi. Cleanout Plugs (on soil pipes)**

UPVC pipe for soil and waste pipes and UPVC Clean out pipe for Rainwater pipes laid under floors shall be provided near pipe junctions bends, tees, "Ys" and on straight runs at such intervals as required as per site conditions. Cleanout pipe shall terminate flush with the floor levels.

**a. Cleanout on Drainage Pipes**

Cleanout pipe shall be provided on starting point of each drain and in between at locations indicated on plans or directed by the Engineer-in-Charge Cleanout pipe shall be of size matching the full bore of the pipe but not exceeding 160 mm OD.

Cleanouts at ceiling level pipe shall be provided with a bend terminating at floor level above. The cap of the cleanout pipe shall have a cap flush with floor.

**vii. Waste pipe from appliances**

**a. General**

- i. Waste pipe from appliances e.g. wash basins, sinks and urinals shall be of UPVC pipes 40, 50 or 63 mm OD conforming to DIN EN, DIN upvc pipe & fitting confirming to drainage system suitable for above & below ground installation inside and outside the building structure shown on the drawings.
- ii. All pipes shall be fixed in gradient towards the outfalls of drains. Pipes inside a toilet room shall be in chase unless otherwise shown on drawings. Where required pipes may be run at ceiling level in suitable gradient and supported on galvanized structural clamps. Spacing for clamps for such pipes shall be as per the pipe spacing chart given.

**viii. Encasing Pipe in Cement Concrete**

UPVC Pipe confirming to BS/ASTM soil and waste pipes and drainage under floor in sunken slabs and in wall chases (when cut specially for the pipe) shall be encased in cement concrete 1:2:4 mix (1 cement : 2 coarse sand : 4 stone aggregate 12 mm size) 75 mm in bed and all-round. When pipes are running well above the structural slab, the encased pipes shall be supported with suitable cement concrete pillars of required height at intervals of one meter.



ix. **Testing**

- i. Testing procedure specified below apply to all soil, waste and vent pipes above ground including pipes laid along basement ceiling.
- ii. Entire drainage system shall be tested for water tightness during and after completion of the installation. No portion of the system shall remain untested. Contractor must have adequate number of expandable rubber/bellow plugs, manometers, smoke testing machines, pipe and fitting work test benches and any other equipment necessary and required to conduct the tests. All testing equipment/motors etc. shall be certified for its calibration by an approved laboratory.
- iii. All materials obtained and used on site must have manufacturer's Hydraulic Test Certificate for each batch of materials used on the site.

x. **Testing Soil, Waste and Rainwater Pipes**

- i. Apart from factory test all pipes and fittings shall be hydraulically tested for a head of 3 m preferably on a specially set up work bench. After applying pressure, strike the pipe with a wooden pallet and inspect for blow holes and cracks. Pressure may be applied for about 2 minutes. Reject and remove all defective pipes.
- ii. After installation all connections from fixtures, vertical stacks and horizontal drains including pipes along ceiling shall be tested to a hydraulic pressure not exceeding 3 m. Such tests shall be conducted for each floor separately by suitable plugs.
- iii. After the installation is fully complete, it should be tested by flushing the toilets, running at least 20% of all taps simultaneously and ensuring that the entire system is self draining, has no leakages, blockages etc. Rectify and replace where required.
- iv. Contractor shall maintain a test register identifying date and time of each area. All tests shall be conducted in presence of Engineer-in-Charge and signed by both.

**LXIV. EXCAVATION FOR PIPE LINE**

**A. EXCAVATION**

The excavation for pipe works shall be open cutting unless the permission of the Engineer-in-Charge for the ground to be tunneled is obtained in writing. Where sewers have to be constructed along narrow passages, the Engineer-in-Charge may order the excavation to be made partly in tunnel and in such cases the excavated soil shall be brought back later on for refilling the trenches or tunnel.

## **B. Opening out Trenches**

- i. In excavation the trenches, etc. the solid road metal ling, pavement, curbing etc. and turf is to be placed on one side and preserved for reinstatement when the trenches or other excavation shall be filled up. Before any road metal is replaced, it shall be carefully shifted. The surface of all trenches and holes shall be restored and maintained to the satisfaction of the Engineer-in-Charge and of the Owners of the roads or other property traversed and the Contractor shall not cut out or break down any live fence of trees in the line of the proposed works but shall tunnel under them, unless the Engineer-in-Charge shall order to the contrary.
- ii. The Contractor shall grub up and clear the surface over the trenches and other excavations of all trees, stumps roots and all other encumbrances affecting execution of the work and shall remove them from the site to the approval of the Engineer-in-Charge.

## **C. Obstruction of Roads**

The Contractor shall not occupy or obstruct by his operation more than one half of the width of any road or street and sufficient space shall then be left for public and private transit, he shall remove the materials excavated and bring them back again when the trench is required to be refilled. The Contractor shall obtain the consent of the Engineer-in-Charge in writing before closing any road to vehicular traffic and the foot walks must be clear at all times.

## **D. Removal of Filth**

All soil, filth or any other offensive matter met with during the execution of the works, immediately after it is taken out of any trench, sewer shall not be deposited on to the surface of any street or where it is likely to be a nuisance or passed into any sewer or drain but shall be at once put into the carts and removed to a suitable place to be provided by the Contractor.

## **E. Excavation to be taken to Proper Depths**

The trenches shall be excavated to such a depth that the pipes shall rest on concrete or on firm bedding as described in the several clauses relating to these so that the inverts may be at the levels given in the sections. In bad ground, the Engineer-in-Charge may order the Contractor to excavate to a greater depth than that shown on the drawings and to fill up the excavation to the level of the sewers with concrete, broken stone, gravel or other materials. For such extra excavation and concrete, broken stone, gravel or other materials, the Contractor shall be paid extra at rates laid down for such works in the schedule, if the extra work was ordered by the Engineer-in-Charge in writing, but if the Contractor should excavate the trench to a greater depth than is required without a specific order to that effect in writing of the Engineer-

in-Charge the extra depth shall have to be filled up with concrete 1:5:10 mix (1 cement: 5 fine sand: 10 stone aggregate 40mm nominal size) at the Contractor's own costs and charges to the requirements and satisfactions of the Engineer-in-Charge.

**F. Refilling**

After the pipes or other work has been laid and proved to be water tight, the trench or other excavations shall be refilled. Utmost care shall be taken in doing this, so that no damage shall be caused to the sewer and other permanent work. The filling in the haunches and upto 75 cms above the crown of the sewer shall consist of the finest selected materials placed carefully in 15 cms layers and flooded and consolidated. After this has been laid, the trench and other excavation shall be refilled carefully in 15 cms layers with materials taken from the excavation, each layer being watered to assist in the consolidation unless the Engineer-in-Charge shall otherwise direct.

**G. Contractor to Restore Settlement and Damages**

The Contractor shall, at his own costs and charges, make good promptly during the whole period the works are in hand, any settlement that may occur in the surfaces of roads, beams, footpaths, gardens, open spaces etc. Whether public or private caused by his trenches or by his other excavations and he shall be liable for any accidents caused thereby. He shall also, at his own expenses and charges, repair and make good and damage done to buildings and other property. If in the opinion of the Engineer-in-Charge he fails to make good such works with all practicable dispatch, the Engineer-in-Charge shall be at liberty to get the work done by the Contractor or deducted from any money that may be or become due to him or recovered from him in any other manner according to the law of the land.

**H. Disposal of Surplus Soil**

The Contractor shall at his own costs and charges provide places for disposal of all surplus materials not required to be used on the works. As each trench is refilled the surplus soil shall be immediately removed, the surface properly restored and roadways and sides left clear.

**I. Timbering of Sewer and Trenches**

The Contractor shall at all times support efficiently and effectively the sides of the sewer trenches and other excavations by suitable timbering, piling and sheeting and they shall be close, timbered in loose or sandy strata and below the surface of the sub soil water level.

All timbering, sheeting and piling with their waling and supports shall be of adequate dimensions and strength and fully braced and strutted so that no risk of collapse or subsidence of the walls of the trench shall take place.

The Contractor shall be held responsible and will be accountable for the sufficiency of all timbering, branches, sheeting and piling used as also for all damage to persons and property resulting from improper quality, strength, placing, maintaining or removing of the same.

**J. Shoring of Buildings**

The Contractor shall shore up all buildings, walls and other structures, the stability of which is liable to be endangered by the execution of the work and shall be fully responsible for all damages to persons or property resulting from any accident.

**K. Removal of Water from Sewer, Trench etc.**

The Contractor shall at all times during the progress of the work keep the trenches and excavations free from water which shall be disposed off by him in a manner as will neither cause injury to the public health nor to the public or private property nor to the work completed or in progress nor to the surface of any roads or streets, nor cause any interference with the use of the same by the public.

**L. Width and Depth of Trench**

The Engineer-in-Charge shall have power by giving an order in writing to the Contractor to increase the maximum width in respect of which payment will be allowed for excavation in trenches for various classes of sewer, manholes, and other works in certain lengths to be specifically laid down by him, where on account of bad ground or other unusual conditions, he considers that such increased widths are necessary in view of the site conditions.

**LXV. WATER SUPPLY SYSTEM (COLD & HOT)**

**A. SCOPE OF WORK**

- i. Work under this section consists of furnishing all labour, materials equipment and appliances necessary and required to completely install the water supply system as required by the drawings & specified hereinafter.
- ii. Without restricting to the generality of the foregoing, the water supply system shall include the following:-
  - a) Municipal water connection including water meter up to U.G. water tanks.
  - b) Domestic water distribution mains from hydro pneumatic system to all fixtures and appliances for cold water to court building.
  - c) Buildings hot water distribution mains from geyser to all fixtures and appliances for hot water to building.
  - d) Excavation and refilling of pipes trenches.
  - e) Control valves, masonry chambers and other appurtenances.

- f) Pipe protection and painting.
- g) Control valves, masonry chambers and other appurtenances.
- h) Connections to all toilet's kitchen equipments, tanks and appliances.
- i) Excavation and refilling of pipe trenches, wherever necessary.
- j) Trenches for taking pipe lines for these services if required.

## **B. GENERAL REQUIREMENTS**

- i. All materials shall be new of the best quality conforming to specifications. All works executed shall be to the satisfaction of the Engineer-in-Charge.
- ii. Pipes and Fittings shall be fixed truly vertical, horizontal or in slopes as required in a neat workmanlike manner.
- iii. Short or Long bends shall be used on all main pipe lines as far as possible. Use of Elbows shall be restricted for short connections.
- iv. As far as possible all Bends shall be formed by means of a hydraulic pipe bending machine for pipes up to 65mm dia.
- v. Pipes shall be fixed in a manner so as to provide easy accessibility for repair and maintenance and shall not cause obstruction in shafts, passages etc.
- vi. Pipes shall be securely fixed to walls and ceilings by suitable clamps at intervals specified.
- vii. As far as possible, all piping inside the buildings shall run either concealed or embedded. Outside the buildings the piping shall be installed at-least 60cms below finished grade. All galvanized steel piping embedded either in trenches or in concrete and masonry work shall be tightly wrapped 1mm thick fiberglass tissue laid in bitumen.
- viii. Valves and other appurtenances shall be so located as to provide easy accessibility for operations, maintenance and repairs.

## **LXVI. Water Supply System**

- i. Contractor should study the site plan and water supply system diagram for an overview of the system.

### **Source**

- a) Water supply will be acquired from Municipal water mains through a service connection
- b) The water mains will be connected to the main fire static tank and then overflow into the main domestic water tank.
- ii. Water supply piping for garden hydrant and sprinkler and irrigation system will be separate and independently connected to a different pumping system.

**LXVII. POLO-POLYMUTANE ML5**

- i. PP-r PE 80 glass fibre compound upto 5 layer piping system in curry/green color with proprietary Ecosan fittings, with operating conditions as per EN ISO 21003, jointing to be by hot socket fusion method and having linear expansion of 0.038 mm/mK, pipes to be painted with ordinary cement paint for external installation .
- ii. LAYER TECHNOLOGY, having:
  - a. 1st layer of PP-r PE 80.
  - b. 2nd and 4th layer of HPCE glass fibre compound for greater stability and a 75% lower linear expansion as compared to single layer pipes.
  - c. 3rd and 5th layer of PP-RCT provides high temperature stability and improved long term resistance.

**Focusing on span distance:  
stable and economical in all locations**

The special multilayer pipe structure of POLO-POLYMUTAN ML<sup>5</sup> ensures a higher stability level which enables greater span distances and saves on costs and materials. No supports are required when laying POLO-POLYMUTAN ML<sup>5</sup>.

Please ensure that the specified distances are not exceeded with laying pipes horizontally.

POLO-POLYMUTAN ML <sup>5</sup> / SDR 7,4							
Dimensions	Media temperature [°C]						
	10	20	30	40	50	60	70
	Span distances [cm]						
20	110	95	90	85	85	80	70
25	120	105	105	95	95	90	80
32	140	120	120	110	110	105	95
40	160	140	135	125	125	120	110
50	185	155	155	145	145	135	130
63	200	175	175	165	165	155	145
75	215	190	190	175	175	165	155
90	230	210	210	195	195	180	180
110	250	220	220	210	200	200	190

## Focusing on long-term internal pressure: Long-term temperature resistance

Long-term stress behaviour with safety factor 1.25					
Temperature °C	Years of operation				
	1	5	10	25	50
	Maximum service pressure in bar				
20 °C	28,5	26,8	26,1	25,2	24,5
30 °C	24,2	22,7	22,1	21,3	20,7
40 °C	20,8	19,2	18,7	18	17,4
50 °C	17,4	16,2	15,7	15,1	14,7
60 °C	14,7	13,6	13,2	12,7	12,3
70 °C	12,3	11,7	11,1	9,6	8,1
80 °C	10,3	9,1	7,7	6,2	
95 °C	7,3	4,9			

System to be in Food Grade quality.

AVAILABLE IN SIZES: 20MM TO 110MM

### LXVIII. CLAMPS

- i. Stainless steel pipes in shafts and other locations shall be supported by galvanized clamps of design approved by Engineer-in-Charge Pipe in wall chases shall be anchored by iron hooks. Pipes at ceiling level shall be supported on structural clamps fabricated from galvanized structural as described in the sub section. Pipes in typical shafts shall be supported on Slotted Angles/Channels as specified elsewhere.
- ii. Pipe hangers shall be provided at the following maximum spacing:

S. No.	Pipe Dia (mm)	Hanger Rod Dia (mm)	Spacing between Supports (Mtr)
1	Up to 25	6	2
2	32 to 50	10	2
3	65 to 100	12	2.4
4	125 to 150	16	3.6
5	200 to 300	19	5.3

**LXIX. TRENCHES**

- i. The galvanized iron pipes and fittings shall be laid in trenches. The width and depth of the trenches for the different diameters of the pipes shall be as follows:

Dia of Pipe	Width of Trench	Depth of Trench
15mm to 50mm	30 cms	60 cms
65mm to 100mm	45 cms	75 cms

- ii. At joints the trench width shall be widened where necessary. The work of excavation and refilling shall be done true to line and gradient in accordance with general specifications for earth work in trenches.
- iii. When excavation is done in rock, it shall be cut deep enough to permit the pipes to be laid on a cushion of sand minimum 7.5 cm deep.

**LXX. PIPE PROTECTION**

Where specified in the Drawing all pipes below ground shall be protected against corrosion by wrapping 100mm wide and 4mm thick layer of PYPKOTE/MAKPOLYKOTE over the pipe.

**LXXI. Sand Filling**

All PPr pipes in trenches shall be protected with fine sand 150 mm all around before filling in the trenches.

**LXXII. VALVES**

- i. Valves 65mm dia and below shall be heavy Gunmetal Full way Valves or Globe Valves or Ball valves conforming to BS: 5159 of 20 Kg/cm<sup>2</sup> class. Valves shall be tested at manufacturer's works and the same stamped on it.
- ii. All Valves shall be approved by the Engineer-in-Charge before they are allowed to be used on work.

**LXXIII. SLUICE VALVES**

- i. All valves 80mm dia and above shall be C.I. Double Flanged Sluice Valves. Sluice valves shall be Cast Iron double flanged, with rising spindle. Each sluice valve shall be provided with wheel for valves in exposed positions and Cap Top for underground valves. Contractor shall provide suitable operating keys for Sluice Valves with Cap Tops.
- ii. Sluice valves shall be of best quality conforming as per relevant Japanese code of class specified.



- a. Joints for double flanged sluice valves shall be made with suitable Tail/socket pieces on the pipeline and flanges joints made with 3 mm thick insertion rubber gasket with appropriate number of bolts, nuts and washers.
- b. Sluice valves shall be installed at all branches and as shown on the drawings.

#### **LXXIV. Scour Valves:**

Scour valves shall be C.I. sluice valves as specified above. They shall be installed at the lowest level or tail end of the system as shown on drawings and directed by Engineer-in-Charge.

#### **LXXV. Air Release Valves**

- Air release valves shall be single acting type air valves with Gunmetal body and bronze/gunmetal internal parts and plastic float.
- Each air release valve shall be provided with a cast iron isolating sluice valve of specification given above.

#### **LXXVI. INSULATION**

##### **A. For Chased Internal Pipes**

Hot water pipes fixed in chase shall be thermal insulation over hot water pipes with 9mm thick nitrile or approved equivalent thermal insulation tubing, a elastomeric flexible material having hermetic blister closed cell structure of expanded synthetic rubber having a thermal conductivity not exceeding  $0.040\text{w/m}^{\circ}\text{k}$  @ 40deg C over pipes.

##### **B. Anchor Block**

Suitable anchor blocks shall be provided at all bends and tees to encounter the excessive thrust developed due to water hammer.

##### **C. PEX PIPING**

- i. Pex piping system shall be confirming to EN ISO 15875-2003 and in confirmation to ASTM F876, 877 and 1807 and CAN/CSA B 137.5 in compliance with ANSI/NSF standard 61 having basic characteristics as given below.
- ii. Fittings shall be in brass / Gm and shall be lead free; fittings shall be supplied by the pipe manufacturer.
- iii. Jointing shall be by use of copper crimping rings using tools and technique as per manufacturer's specification only.

• 3/8", 1/2", 3/4", 1" pex pipe according to ASTM F876/F877

Table1- pipe dimension

Nominal size	Outside diameter(mm)	Tolerance for outside diameter	Minimum wall-thickness(mm)	Tolerance on wall-thickness(mm)
3/8"	12.70	± 0.08	1.78	+ 0.25
1/2"	15.88	± 0.1	1.78	+ 0.25
3/4"	22.22	± 0.1	2.47	+ 0.25
1"	28.58	± 0.12	3.18	+ 0.33

Table2- maximum pressure

Nominal size	Temperature 23°C	Temperature 82.2°C	Temperature 93.3°C	Temperature 99°C*
3/8"	42.7 bar	19.0 bar	16.2 bar	10.34 bar
1/2"	33.1 bar	14.8 bar	14.8 bar	10.34 bar
3/4"	32.7 bar	14.5 bar	12.4 bar	10.34 bar
1"	32.7 bar	14.5 bar	12.4 bar	10.34 bar

- iv. **PEX** shall be used for inter piping of size (1/2" and 3/4" only). System shall be in Pliable or non-Pliable form as per details given in the specifications.

**D. VALVE CHAMBERS**

Contractor shall provide suitable brick masonry chambers in cement mortar 1:5 (1 cement: 5 coarse sand) on cement concrete foundations 150 mm thick 1:5:10 mix (1 cement: 5 fine sand: 10 graded stone aggregate 40 mm nominal size) 12 mm thick cement plaster inside and outside finished with a floating coat of neat cement inside with cast iron surface box as approved or as specified in Drawing and in drawings including excavation, back filling complete.

**E. WATER METERS**

Water meters of approved make and design shall be supplied for installation at locations as shown in drawing The water meters shall meet with the approval of the CWA. Suitable valves and chambers to house the meters shall also be provided along-with the meters.

All meters shall conform to international/BS (Water meters-domestic type) and water meters-bulk type. Where called for water meters shall be located in masonry chambers of appropriated size.

#### **F. PIPE HANGERS BRACKETS ETC.**

- i. Sturdy hangers, brackets and saddles of approved design shall be installed to support all pipe lengths which are not embedded over their entire run. The hangers and brackets shall be of adjustable heights and primer coated with red-oxide primer clamps. Collars and saddles to hold pipes shall be provided with suitable gaskets. The brackets and hangers shall be of Mild Steel designed to carry the weight of pipes safely and without excessive deflections.
- ii. All pipes and fittings shall be supported near every joint and half-way through every pipe length unless otherwise specified. Where called for, pipe hangers shall also be supplied with proper sound and vibration dampening devices to minimize noise and vibration transmission.

#### **G. TESTING**

- i. All pipes, fittings and valves shall be tested by hydrostatic pressure of min. 1.5 times, the working pressure and subject to minimum of 7 kg/cm<sup>2</sup> in any case and with the consent of Engineer-in-Charge.
- ii. Pressure shall be maintained for a period of at least TWELVE hours without appreciable drop in the pressure after fixing at site. (+10 %). A test register shall be maintained and all entries shall be signed and dated by Contractor(s) and Engineer.
- iii. In addition to the sectional testing carried out during the construction, Contractor shall test the entire installation after connections to the overhead tanks or pumping system or mains. He shall rectify all leakages, and shall replace all defective materials in the system. Any damage done due to carelessness, open or burst pipes or failure of fittings, to the building, furniture and Fixtures shall be made good during the defects liability period without any extra cost.
- iv. After completion of the water supply system, Plumbing Contractor shall test each valve by closing and opening it a number of times to observe if it is working efficiently. Valves which do not effectively operate shall be replaced by new ones at no extra cost and the same shall be tested as above.

#### **H. CONNECTIONS TO WATER TANKS**

- i. The contractor shall provide all inlets, outlets, washouts, vents, ball cocks, overflow, control valves and all such other piping connections including level indicator to water storage tanks as called for.

- ii. Suitable float controls of an approved make, securely fixed to the tank independent of the inlet pipe and set in a position so that water inlet into the tank is cut off when filled up to the water line. The water level in the tanks shall be adjusted to 25mm below the lip of the overflow pipe. Full way gate/ball valves of approved make shall be provided as near the tank as practicable on every outlet pipe from the storage tank except the overflow pipe.
- iii. The overflow pipe shall be so placed as to allow the discharge of water being readily seen. The overflow pipe shall be of size indicated. A stop valve shall also be provided on the inlet water connection to the tank. The outlet pipes shall be fixed approximately 75mm above the bottom of the tank towards which the floor of the tank is sloping to enable the tank to be emptied for cleaning. The ball valves shall conform to Standard BS.

#### **I. CONNECTIONS TO MECHANICAL EQUIPMENT SUPPLIED BY OTHER AGENCIES**

All inlets, outlets, valves, piping and other incidental work connected with installation of all mechanical equipment supplied by other agencies shall be carried out by the Plumbing contractor in accordance with the drawings, requirements for proper performance of equipment, manufacturer's instructions and the directions of the Engineer-in-Charge. The equipment to be supplied by other agencies consists mainly of Air-conditioning, Water Treatment and other similar equipment. The connections to the various equipment shall be affected through proper unions and isolating valves. The work of effecting connections shall be executed in consultation with and according to the requirements of equipment suppliers, under the directions of the Engineer-in-Charge. The various aspects of connection work shall be executed in a manner similar to the work of respective trades mentioned elsewhere in these specifications.

#### **J. DISINFECTION**

- i. After completion of the work Contractor shall flush clean the entire system with the city's filtered water after connection has been made.
- ii. After the first flushing, commercial bleaching powder is to be added to achieve a dosage of 2 to 3 mg/l of water in the system added and flushed. This operation should be performed twice to ensure that the system is fully disinfected and usable. The Commissioning would not be considered complete without performing the Disinfection.

#### **K. PRE-COMMISSIONING:**

- i. Ensure that all pipes are free from debris and obstructions.
- ii. Check all valves and fire hydrant for effective opening and closing action. Defects should be rectified or valves replaced.
- iii. Ensure that all Connections to Branches has been made.

- iv. Ensure that mains have been connected to the respective pumps, underground and Overhead tanks.
- v. Water supply should be available at main Underground tank.
- vi. All main line Valves should be closed.

#### **L. COMMISSIONING**

- i. Fill Underground tank with water. Add 1kg fresh bleaching powder after making a solution to be added near inlet by a separate specialist contractor.
- ii. Main water to fill main Underground tank. Water will first fill the fire tank and then overflow to the Raw Water tanks.
- iii. After filling Overhead Reservoir drain the same to its one fourth capacity through tank scour valve. (This is to ensure removal of all mud, debris etc. from the tank).
- iv. Fill Overhead tank to full.
- v. Release water in the main lines by opening Valves in each circuit. Drain out water in the system through scour valves or fire hydrant in lower regions. Ensure clean water is now coming out of the system.
- vi. Open valves for individual clusters. Observe for leakages or malfunctions, check pressure & flow at end of line by opening Hydrants etc. Remove and rectify defects noticed.
- vii. Check all outlet points for proper operation by opening each valve and allowing water to flow for a few minutes. Also check for effective closure of valve.
- viii. The entire water supply system should be disinfected with bleaching powder and system flush cleaned.
- ix. Send four samples of water drawn from four extreme locations for testing for bacteriological test in sterilized bottles obtained from the concerned laboratory. (Laboratory personal may collect the samples themselves).

#### **M. RESPONSIBILITY**

Responsibility for various activities in pre-commissioning and commissioning procedures will rest with the Contractor.

## **LXXVII. SEWERAGE/DRAINAGE SYSTEM**

### **A. SCOPE OF WORK**

- i. Work under this section shall consist of furnishing all Labor, Materials, Equipments and Appliances necessary and required to completely finish Sewerage/Drainage system as specified hereinafter or given in the Drawing.
- ii. Without restricting to the generality of the foregoing, the sewerage system shall include:
  - a. Internal/External sewer line.
  - b. Excavations including refilling etc.
  - c. Construction of Collection Chambers, Manholes and Drop Connections.
  - d. Construction of Grease Trap etc.
  - e. Connection to municipal sewer line.
  - f. Storm Water Drainage and Disposal.
  - g. Testing of pipe lines

### **B. GENERAL REQUIREMENTS**

- i. All materials shall be new of the best quality conforming to specifications and subject to the approval of the Engineer-in-Charge.
- ii. Drainage lines shall be laid to the required gradients and profiles.
- iii. All piping shall be installed at depth greater than 80cms below finished ground level.
- iv. The piping system shall be vented suitably at the starting point of all branch drains, main drains, and the highest/lowest point of drain and at intervals as shown. All venting arrangement shall be un-obstructive and concealed.
- v. All drainage work shall be done in accordance with the local Municipal by-laws.
- vi. Wherever the sewerage pipes run above water supply lines, same shall be completely encased in cement concrete 1:2:4 all round with the prior approval of the Engineer-in-Charge.
- vii. Location of all manholes, catch basins etc., shall be got confirmed by the Contractor from the Engineer-in-Charge before the actual execution of work at site.
- viii. All works shall be executed as directed by Engineer-in-Charge.

### **C. ALIGNMENT AND GRADE**

1. The sewer pipes shall be laid to alignment and gradient shown on the drawings but subject to such modifications as shall be ordered by the Engineer-in-Charge from time to time to meet the requirements of the works. No deviations from the lines, depths of cutting or gradients of sewers shown on the plans and sections shall be permitted except by the express direction in writing of the Engineer-in-Charge.

#### **i. Sewerage and storm water PIPES**

- a. The sanitation systems shall be installed to comply with the requirements of BS EN 12056-1 and BS EN 12056-2 as well as the specific requirements of this specification.
- b. The completed installation shall ensure compliance with the Local Municipality Regulations and recommendations.
- c. The system shall be installed to effectively convey discharges quickly, quietly and effectively without nuisance or risk to health. It is essential that foul air is prevented from entering the building during operation of the system.
- d. Falls and slopes of branch soil and waste pipes shall be to the requirements of BS EN 12056-2.
- e. Ventilation and anti-siphonage pipework shall be installed to be self-draining in its entirety.
- f. Pipes shall be installed true to line and to a consistent gradient. All vertical drainage pipework shall be perpendicular and branches and changes in direction adequately supported.
- g. Obtain all components for all types of pipework from the same manufacturer unless stated otherwise.
- h. No offsets shall be included in the vertical stacks except where indicated or will occur in the ventilating section of the stack. The requirement for additional offsets shall be agreed with the Engineer-in-charge.
- i. Access for cleaning and rodding pipes shall be provided to ensure that all parts of the systems are accessible for such purposes.
- j. As a minimum, an access point shall be provided on each vertical stack at each storey level (above the highest spill over level of the connected fittings), at changes of direction and junctions on suspended pipework, and at the upstream end of horizontal branch soil and waste pipes.
- k. All branch connections to horizontal runs at high level shall be made using 45 degree branches swept in the direction of flow wherever possible.
- l. Allow for thermal and building movement when jointing and fixing pipework.
- m. Thermal movement shall be accommodated in pipe runs in accordance with the manufacturer's recommendations utilizing the correct joints to incorporate thermal movement.
- n. All metallic pipe systems shall be continuity bonded and tested to ensure continuity in accordance with BS 7671 and as stated elsewhere.

- o. Where plastic pipes with an outside diameter larger than 110mm penetrate fire compartment walls or floors, a proprietary intumescent fire collar shall be installed on the pipe to maintain the integrity of the fire barrier.
  - p. Any damage to manufacturers paint finishes shall be made good to the manufacturer's recommendations and colour specification.
  - q. All floor drains in plant rooms shall have cast iron gratings.
  - r. All drainage piping, unless otherwise indicated, shall be pitched at a minimum rate in direction of flow, in accordance with local Municipality Standards.
  - s. The Contractor shall handle fittings into and out of store to job site and they shall be well protected from damage. After the installation, the fixtures shall be covered by protective crating with carton cardboard and plastic sheets until handover.
  - t. The Contractor shall supply all jointing and fixing materials and seal to structure with polysulphide sealant and make all connections to water supply services, overflows and waste.
  - u. All pipework shall be installed and supported adequately to withstand the pressures experienced on the high rise stacks. Particular attention shall be paid to anchoring of vertical riser's final long radius bends and vertical stack expansion. The Contractor shall be responsible for obtaining the pipework manufacturers guidance and recommendations in this regard and installing accordingly to the Engineer-in-charge approval.
  - v. All testing to be carried out in accordance with the local authority requirements and British Standards
  - w. During the progress of the work, test the waste and storm drainage systems to permit general construction and building in of rough work to proceed.
  - x. Provide all apparatus and temporary work for tests. Take all due precautions to prevent damage to any part of the building.
  - y. No caulking of pipe joints to remedy leaks will be permitted except where lead and oakum joints are used.
  - z. Each sections of drainage and roughing piping tested shall have all openings tightly closed with screw plugs, or equal device, and shall stand without loss of level for a period of four hours when filled with water to produce at least a 3-meter head at the highest point of the section tested.
  - aa. The Contractor shall maintain system until handover and ensure that at handover the systems are clean and free of blockage.
2. The Contractor shall offer the complete system to the local authority for testing and inspection and shall obtain approval from the local authority prior to the handover of the building.
3. All pipework shall be identified in accordance with BS 1710.



4. Soil, waste and ventilation pipework, 75mm. diameter and above shall be installed, using PVC-U pipe and fittings complying with BS EN 1329-1.
5. Waste and anti-syphon pipework, 50mm diameter and below, shall be installed, using PVC-U pipe and fittings complying with BS EN 1329-1.
6. All fittings shall be of compatible materials of the same manufacture, with solvent weld or seal ring joints, and are to be stored, assembled, supported and tested in accordance with the manufacturer' instructions.
7. Where jointing to different materials, the correct transitional fittings shall be used in accordance with the manufacturer's instructions.
8. All drainage pipework run in the ceiling voids of the building above noise sensitive areas (or as required to achieve specified room NC/NR levels for services in Part 2) shall be insulated with acoustic lagging to minimize noise transmission. The acoustic insulation shall be minimum 25mm thick and shall achieve a minimum noise reduction of 20dBA. The surface density of the insulation shall be 4.5kg/m<sup>2</sup> or as required to achieve the necessary sound reduction.
9. The Contractor shall allow for contraction and expansion of pipework and anchoring as required. Particular attention shall be given to the base of main stacks where long radius bends shall be provided and suitably anchored/restrained to cater for the higher pressures experienced. The Contractor shall submit suitable fittings and support system as recommended by the manufacturer for the Engineer-in-charge approval.

**ii. Laying of Sewerage and storm Pipes**

**a. Laying of Pipes**

1. Pipes are liable to be damaged in transit and notwithstanding tests that may have been made before dispatch each pipe shall be examined carefully on arrival at site. Each pipe shall be rung with a wooden hammer or mallet and those that do not ring true and clear shall be rejected. Sound pipes shall be carefully stacked to prevent damage. All defective pipes should be segregated, marked in a conspicuous manner and their use in the works prevented.
2. The pipes shall be laid with sockets leading uphill and should rest on solid and even foundations for the full length of the barrel. Socket holes shall be formed in the foundation sufficiently deep to allow the pipe jointer room to work right round the pipe and as short as practicable to admit the socket and allow the joint to be made.
3. Where pipes are not bedded on concrete the trench bottom shall be left slightly high and carefully bottomed up as pipe laying proceeds so that the pipe barrels rest on firm ground. If excavation has been carried too low it shall be made up with cement concrete 1:5:10 mix at the Contractor's cost and charges.
4. If the bottom of the trench consists of rock or very hard ground that cannot be easily excavated to a smooth surface, the pipes shall be laid on cement concrete bed of 1:5:10 mix to ensure even bearing.

**b. Gully Traps**

Gully traps shall be of the same quality as described in specifications.

Gully traps shall be fixed in cement concrete 1:5:10 mix (1 cement: 5 coarse sand: 10 stone aggregate 40mm nominal size) and a brick masonry chamber 30x30 cms inside in cement mortar 1:3 with 10 x 10 cms grating inside and 30x30 cms C.I. sealed cover and frame weighting not less than 7.2 kg to be constructed as per standard drawing. Where necessary, sealed cover shall be replaced with C.I. grating of the same size.

**c. Grease Trap**

Grease Trap shall be provided on Kitchen waste lines before discharging the waste into the main sewer line. Grease Trap shall be same quality as described in specifications and shall be similar in construction to manholes. The grease trap shall be constructed to size as shown at the location on drawings. The grease trap shall be provided with drop inlet, drop outlet, galvanized wrought iron sediment pan and a baffle wall. Grease trap shall be provided with 2 Nos, double seal manhole cover and frame which shall be identified with lettering `Grease trap" as per the drawing.

**d. Testing of Grease Trap**

All rights of the sewer and drain shall be carefully tested for water tightness by mains of water pressure maintained for not less than 30 minutes. Testing shall be carried out for manhole to manhole. All pipes shall be subject to a test pressure of 1.5-meter head of Water. The test pressure will however, not exceed 6mtr head at any point. The pipes shall be plugged preferably with standard design plugs or with rubber plugs on both sides, the upper end shall, however, be connected to a pipe for filling with water and getting the required head poured at one time.

**e. Encasing (all pipes have to be encased)**

The sewer pipes shall be completely encased or surrounded with concrete where:

- i. The maximum water table level is likely to rise above the top of the barrel.
- ii. The top (overt) of pipe is less than 200 cms under the road surface.

## **LXXVIII. CEMENT CONCRETE AND MASONRY WORKS FOR MANHOLES AND CHAMBERS ETC.**

### **A. Materials**

#### **i. Water**

Water used for all the construction purposes shall be clear and free from Oil, Acid, Alkali, Organic and other harmful matters, which shall deteriorate the strength and/or durability of the structure. In general, the water suitable for drinking purposes shall be considered well enough for construction purpose.

#### **ii. Aggregate for Concrete**

The aggregate for concrete shall be in accordance with BS in general; these shall be free from all impurities that may cause corrosion of the reinforcement. Before actual use these shall be washed in water, if required as per the direction of Engineer-in-Charge. The size of the coarse aggregate shall be done as per BS.

#### **iii. Sand**

Sand for various constructional purposes shall comply in all respects BS. It shall be clean, coarse hard and strong, sharp, durable, uncoated, free from any mixture of clay, dust, vegetable matters, mica, iron impurities soft or flaky and elongated particles, alkali, organic matters, salt, loam and other impurities which may be considered by the Engineer-in-Charge as harmful for the construction.

#### **iv. Cement**

The cement used for all the constructional purposes shall be ordinary Portland cement or rapid hardening Portland cement conforming to BS.

#### **v. Mild Steel Reinforcement**

The mild steel for the reinforcement bars shall be in the form of round bars conforming to all requirements of BS.

#### **vi. Bricks**

Bricks shall have uniform color, thoroughly burnt but not over burnt, shall have plan rectangular faces with parallel sides and sharp right angled edges. They should give ringing sound when struck. Brick shall not absorb more than 20% to 22% of water, when immersed in water for 24 hours. Bricks to be used shall be approved by the Engineer-in-Charge.

#### **vii. Other Materials**

Other materials not fully specified in these specifications and which may be required in the work shall conform to the BS code. All such materials shall be approved by the Engineer-in-Charge before use.

**viii. Cement Concrete (Plain or Reinforced)**

- i. Cement concrete pipes bedding, cradles, foundations and RCC slabs for all works shall be mixed by a Mechanical Mixer where quantities of the concrete poured at one time permit. Hand mixing on properly constructed platforms may be allowed for small quantities by the Engineer-in-Charge. Rate for cement concrete shall be inclusive of all shuttering and centering at all depth and heights.
- ii. All concrete work shall be cured for a period of at least 7 days. Such work shall be kept moist by means of gunny bass at all times. All pipe trenches and foundations shall be kept dry during the curing period.

**ix. Masonry Work**

Masonry work for manholes, chambers, brick masonry pipe trench and such other works as required shall be constructed from 1st class bricks or 2nd class as specified in the Drawing in cement mortar 1:5 mix (1 cement: 5 coarse sand). All joints shall be properly raked to receive plaster.

**x. Cement Concrete for Pipe Support**

- i. Wherever specified or shown on the drawings, all pipes shall be supported in concrete bed all round or in haunches. The thickness and mix of the concrete shall be given in the Drawing. Type of the bedding is as described as follows:
- ii. Unless otherwise directed by the Engineer-in-Charge cement concrete for bed, all round or in haunches shall be laid as follows:-

Description	Upto 3 M depth
Pipes in open ground (No sub soil water)	All round (1:4:8)
Pipes (all) in sub soil water condition	All round (1:4:8)
Pipes under the building or at road crossing or under public places	All round (1:3:6)

(1=1 cement, 3-5=coarse sand, 6-10 stone aggregate 40mm nominal size)

- iii. R.C.C. pipes or PVC-U. Pipes may be supported on brick masonry or precast R.C.C or Cast in-situ cradles. Cradles shall be as shown on the drawings.
- iv. Pipes in loose soil or above ground shall be supported on brick or RCC anchor blocks as shown on the drawings.

**xi. MANHOLES AND CHAMBERS**

- i. All manholes, chambers and other such works as specified shall be constructed in brick masonry in cement mortar 1:5 (1 cement: 5 coarse sand) or as specified in the Drawing.
- ii. All Manholes, Chambers, etc., shall be supported on base of cement concrete of such thickness and mix or shown on the drawings.
- iii. Where not specified, Manholes will be constructed as follows: -

*(All dimensions internal clear in cms)*

Size of Manhole Type	90x80 Rect.	120x90 Rect.	910 dia Circular	1220 dia Circular	1520 dia Circular
Maximum depth	100	245	170	230	Any depth beyond 230
Average thickness of R.C.C slab	15	15	--	--	--
Size of cover and frame (Internal dia)	61x45.5	50 dia	56 dia	56 dia	56 dia
Weight of cover and frame	38 Kg.	116 Kg.	116 Kg.	116 Kg.	116 Kg.
Type of Cover & Frame	SFRC	SFRC	SFRC	SFRC	SFRC

- iv. All manholes shall be provided with cement concrete benching in 1:2:4 mix (1 cement: 2 coarse sand: 4 stone aggregate 20mm nominal size). The benching shall have a slope of 10cm towards the channel. The depth of the channel shall be full diameter of the pipe. Benching shall be finished with a floating coat of neat cement.
- v. All manholes shall be plastered with 12/15mm thick cement mortar 1:3 (1 cement: 3 coarse sand) and finished with a floating coat of neat cement inside. Manhole shall be plastered outside as above but with rough plaster.
- vi. All manholes with depths greater than 1 M. shall be provided with plastic encapsulated 20mm square or 25mm round rods foot rungs set in cement

concrete blocks 25 x 10 x 10cms in 1:2:4 mix 30cms vertically and staggered. Foot rests shall be coated with coal tar before embedding.

- vii. All manholes shall be provided with cast iron covers and frames and embedded in reinforced cement concrete slab or SFRC precast concrete covers as per instructions of the Engineer-in-Charge. Weight of cover, frame and thickness of slab as given above.
- viii. All Rainwater Collection Chamber shall be of the size 50x45x60cm (internal) with horizontal C.I. grating or SFRC precast Gully Grating as per instructions of Engineer-in-Charge. The grating along with frame shall be of size 500x450mm grating having total Wt. of app. 38 Kg and of approved design and quality as per instruction of Engineer-in-Charge. The remaining details of construction shall be same as stated above for the construction of the Manholes etc.

**xii. MAKING CONNECTIONS**

Contractor shall connect the new sewer line to the existing manhole by cutting the walls, benching and restoring them to the original condition. A new channel shall be cut in the benching of the existing manhole for the new connection. Contractor shall remove all sewage and water if encountered in making the connection without additional cost.

**xiii. COMMISSIONING**

After successful testing of the different sewerage and drainage pipes in parts, the Contractor shall provide all facilities including necessary piping's, labors, tools and equipments etc. for carrying out testing and commissioning of the entire external sewerage and drainage system complete as per requirement in the presence of Client representative/Consultant, wherever and as may be required. Generally, the following test/inspection has to be carried out: -

- a. For any Leakages/seepages in the external sewerage and drainage pipes.
- b. For checking the functioning of the entire external sewerage and drainage system including rainwater harvesting system and to ensure that the waste water is continuously flowing towards outfall without any intermediate stagnation.
- c. For the functioning of the valves and accessories etc. by putting ON/OFF the controlling valves of the various diversions in the sewerage and drainage and rain water harvesting system.

**LXXIX. HANDING OVER PROCEDURE**

**i. DOCUMENTS SUBMISSION**

The Contractor shall before finally handing over the completed work in his scope to the Owner, submit the documents as per the Contract and as directed by the Engineer-in-Charge. Given below the checklist for the reference of the Engineer-in-Charge.

<b>Packages/</b>	<b>Sanitary Fixtures</b>	<b>Soil, waste &amp; vent pipes</b>	<b>Water supply system</b>	<b>Sewerage/ drainage system</b>	<b>Water tanks</b>
Final cleaning					
List of inventory					
Training Conducted on					
Operation Manual					
Maint. Manual					
As built P&I Diag/ SLD					
Defects Liability Period/ Warranty					
Commissioning report					
Test reports/ Certificates					
List of essential spares					
Address/ Contact nos. of Vendors					
Remarks					

## 5 Chapter E

### FIRE FIGHTING SYSTEM

#### I. TECHNICAL SPECIFICATION

- i. Work under this sub-head consists of furnishing all Labor, Materials, equipment and accessories necessary and required to completely install the Fire Fighting equipment etc., specified hereinafter and given in the
- ii. Without restricting to the generality of the foregoing the work of Fire Fighting System shall include the followings:
  - a. Providing M.S. black steel (Class C) pressure pipe line main including Valves, Fire Hydrants, Excavation for Pipe, Laying of pipe, Painting of pipe and Making Connection to supply system.
  - b. Black Steel Pipe, Mains Laterals, Branches, Valves, Hangers and Appurtenances.
  - c. Hose Reels, Rubberized fabric lined hose pipes, Hose cabinets, Sprinkler heads and Landing Valves.
  - d. Portable Fire Extinguishers
  - e. Testing Commissioning and giving live demonstrations to the various Inspection Authorities and Obtain their "No Objection Certificate" (NOC) for occupation of the building.

#### II. GENERAL REQUIREMENTS

- i. All materials shall be of the best quality conforming to the Specifications and subject to the approval of the Engineer-in-Charge.
- ii. Pipes and Fittings shall be fixed truly Vertical, Horizontal or in slopes as required in a neat workman like manner.
- iii. Pipes shall be fixed in a manner so as to provide easy accessibility for repair and maintenance and shall not cause any obstruction in shaft, passage etc.
- iv. Pipes shall be securely fixed to walls and ceiling by suitable clamps at intervals specified. Only approved type of anchor fasteners shall be used for RCC ceilings.
- v. Valves and other appurtenance shall be so located that they are easily accessible for operation, repairs and maintenance.

#### III. PIPES

All pipes within and outside the building in exposed locations and shafts including connections buried under floor shall be G.I. Pipes shall be as per BS standard.



#### IV. PIPE FITTINGS

- i. Pipes and fittings mean tees, elbows, couplings, flanges, reducers etc. And all such connecting devices that are needed to complete the piping work in its totality.
- ii. Fabricated fittings shall not be permitted for pipe diameters 50 mm and below.
- iii. When used, they shall be fabricated, welded and inspected in workshops under supervision of Engineer-in-Charge whose welding procedures have been approved by the TAC as per TAC rule 4102 for sprinkler system and applicable to hydrant and sprinkler system. For "T" connections, pipes shall be drilled and reamed. Cutting by gas or electrical welding will not be accepted.

#### V. FITINGS

- i. All pipe work, valves and fittings, unless otherwise specified, shall comply with relevant clauses in the NFPA 13 regulations.
- ii. Supply, deliver and install all pipe work materials and fittings for the standpipe and hose systems.
- iii. Pipe work shall follow the routes and approximate positions indicated on the drawings.
- iv. Pipe work, ancillaries, valves and demountable joints shall be installed for convenient and safe routine maintenance and renewals.
- v. Provide pipe hangers in accordance with NFPA 13.
- vi. All pipe work shall be installed with adequate gradients to facilitate draining and venting.
- vii. Pipe work shall be run in a neat manner and installed plumb, straight, symmetrical and at right angles to or parallel to adjacent walls.
- viii. No joints shall be formed in wall or floor thickness.
- ix. All pipe work, fittings and valves shall be free from corrosion, scale and internal obstruction.
- x. Pipe work ends shall be cut square reamed free from burrs and finished full bore.
- xi. Sufficient unions and flanged joints shall be provided to install and dismantle sections of pipe work, wherever difficulty in dismantling may occur and on straight runs of more than 25m.
- xii. Unions or flanges shall be provided at all valves and equipment for easy dismantling. Connections to coils, pumps, and other equipment shall be made in such a manner as to eliminate undue strains in piping and equipment. Necessary fittings and bends shall be furnished to avoid springing of pipes during assembly.
- xiii. Care shall be taken in placing unions to allow freedom to spring apart. Unions and flanges shall not be placed in inaccessible positions. Where pipe work is installed in inaccessible places, a union or flange shall be installed, prior to the

- pipe passing into the wall or floor. Unions shall have two bronze conical seats ground in. Long screw connections will not be accepted.
- xiv. All black mild steel pipe work in wall chases shall be welded throughout with flanged joints at 16 m maximum intervals if applicable.
  - xv. Manufacturer's standard fittings shall be used and fabricated fittings will not be accepted without approval.
  - xvi. Bends and tees shall be of the easy sweep type, except at air vents, drain points and dead legs where square tees shall be used.
  - xvii. Changes in diameter of horizontal pipe work shall be formed eccentrically.
  - xviii. Prior to any work being "covered up", the Contractor shall request the Engineer's approval to that part of the installation in question.
  - xix. Pre-fabricated pipe work shall be in accordance with the relevant clauses.
  - xx. Take appropriate means to prevent galvanic action where dissimilar metals are connected.
  - xxi. For working pressures below 20 bar the pipe work shall be seamless factory galvanized steel in accordance with ASTM A 53 grade B schedule 40.
  - xxii. Fittings on 50 mm and below shall be galvanized malleable iron fittings conforming to class 250, ANSI B16.4 and shall be UL listed, FM approved.
  - xxiii. Fittings 65mm and above shall be factory galvanized mechanical roll grooved fittings and shall be UL listed, FM approved. These shall be class 250 to ANSI B16.9.
  - xxiv. For working pressures above 20 bar the pipe work shall be seamless factory galvanized steel in accordance with ASTM A 53 grade B schedule 80.
  - xxv. Fittings on 50 mm and below shall be galvanized malleable cast iron fittings conforming to class 300, ANSI B16.3 and shall be UL listed, FM approved.
  - xxvi. Fittings 65mm and above shall be factory galvanized mechanical roll grooved fittings and shall be UL listed, FM approved. These shall be class 300 to class 16.9.
  - xxvii. All valves and fittings used in the pipe work system shall not have a pressure rating less than that of the pipe work.
  - xxviii. Provide sleeves for each pipe passing through walls, partitions, and floors.
  - xxix. Sleeves which are contained in walls, ceilings or floors which are fire barriers shall be additionally packed with a non-combustible material for the entire length to form a fire/smoke stop of the required fire rating.
  - xxx. The material shall be subject to approval and must comply with Japanese authority.
  - xxxi. UL listed expansion joints shall be provided for all pipe work passing through any building expansion joint and where necessary as specified and are designed for use in fire protection piping systems.

- xxxii. All piping shall be thoroughly cleaned of loose scale, dirt, etc., before installation. During the course of the installation, all open ends of pipes shall be plugged or capped to prevent ingress of dirt.
- xxxiii. After installation and sealing of joints all piping shall be thoroughly cleaned with clean water under pressure to the satisfaction of Engineer. Water samples test may be required if the Engineer is considered as necessary. Water used for this purpose shall be discharged as directed.
- xxxiv. Any temporary pipe work and equipment necessary for the above cleaning shall be provided by the Contractor.
- xxxv. Provide a pressure gauge with an isolation cock with inspector's test plug on top of each sprinkler pipe risers.

#### VI. PIPE PROTECTION

- i. All pipes above ground and in exposed locations shall be painted with one coat of Red Oxide Primer and two or more coats of Synthetic Enamel Paint of approved shade.
- ii. All black steel pipes under floors or below ground shall be provided with protection against corrosion by application of 100mm wide and 4mm thick layer of PYPKOTE/ MAKPOLYKOTE over the pipe, as per manufacturers specifications.

#### VII. PIPE SUPPORTS

- i. All pipes shall be adequately supported from ceiling or walls from existing/new inserts by Structural clamps fabricated from M.S. Structural e.g. Rods, Channels, Angles and Flats as per details given in drawings and specifications. All clamps shall be painted with one coat of red lead and two coats of black Enamel paint.
- ii. Where inserts are not provided, the Contractor shall provide anchor fasteners. Anchor fastener shall be fixed to walls and ceilings by drilling holes with Electrical drill in an approved manner as recommended by the manufacturer of the fasteners.

#### VIII. TESTING

- i. Test all Fire Fighting systems in accordance with NFPA 14.
- ii. Carry out any additional tests required by the authorities having jurisdiction.
- iii. Perform tests in the presence of each governing authority's authorized inspector.
- iv. Submit certification that systems have been designed and installed in accordance with NFPA 14 and the requirements of the local Japanese Authority.
- v. Perform tests before piping is concealed.
- vi. Remove all components which will not withstand test pressure, and replace after tests.

- vii. Eliminate leaks, or remove and refit defective parts. Caulking of threaded or welded joints will not be permitted.
- viii. Repeat tests as often as necessary to obtain certification

#### IX. ANCHOR BLOCK

Contractor shall provide suitable cement concrete, anchor blocks of ample dimensions at all bends, tee connection and other places required and necessary for overcoming pressure thrusts in pipes. Anchor blocks shall be of cement concrete 1:2:4 mix (1 cement: 2 coarse sand: 4 stone aggregate 20 mm nominal size).

#### X. VALVES

##### **Valves, Gauge and Orifice Plates**

- i. Unless otherwise indicated all valves controlling connections to water supplies and systems shall be UL listed and indicating valves and shall be in accordance with NFPA 13 & 14.
- ii. All valves shall have the name of the manufacturer and working pressure cast or stamped on body.
- iii. All valves shall be selected for the working pressure and test pressure required.
- iv. All isolating valves and control valves shall be provided with the proper and efficient operation and maintenance of the entire systems.
- v. Furnish all valves and accessory material necessary in the piping whether or not shown on drawings as follows.
- vi. All valves shall be packed with an approved packing and threads shall be coated with oil and graphite. Packing should be replaced when found deteriorated on site.
- vii. Plastic or metal plates (rustles) shall be provided to indicate the open/close status as well as the use of each valve in the pump and tank rooms, and in the town main.

#### XI. EXTERNAL YARD HYDRANTS

- i. The Contractor shall provide External Fire Hydrant in the Ring or on External Fire Line, as per specifications and as shown in drawings. The spacing of the hydrants and the distance from the building shall be maintained as per relevant requirements of latest relevant codes, unless specified herewith.
- ii. Each External Fire Hydrant shall be provided with an External Fire Hose Cabinet of M.S of size as per specifications, as approved by the Architect to equip 2 nos. of 63 mm dia controlled percolating hose and accessories as required. The cabinet shall be installed near the Hydrant as per details, approved by the Engineer-in-Charge / Architect.

**XII. INTERNAL HYDRANTS**

- i. Comply with General Requirements and all documents referred to therein.
- ii. Provide all labor, materials, products, equipment and services to supply and install standpipe and hose systems as indicated on the Drawings and specified in this Section of the Specification in accordance with NFPA 14 and to the requirements of local Japanese Authority.
- iii. The fire protection contractor shall be experienced in the design and installation of fire protection systems to NFPA standards and shall be an approved contractor by local Japanese Authority.
- iv. Standpipe system piping shall be sized by hydraulic calculations in accordance with NFPA 14 and a complete set of calculations shall be submitted with the plans for engineer's review.
- v. Submit system layout drawings, component shop drawings, specifications and hydraulic calculations for consultants review prior to commencing installation.
- vi. Submittal data shall be reviewed and incorporate requirements of the local authorities. Drawings shall be certified correct and bear the contractors engineers certification prior to submission to the consultant.
- vii. Upon completion of the installation, modify the system calculations and submit hydraulic design data based on as-built system.
- viii. Obtain all approvals before proceeding with the work.
- ix. Provide certificate of compliance that components are compatible and, where applicable, certified for intended use by recognized testing agency.
- x. Meet local building and fire regulations, including the most recent issue of the following:
  - a. NFPA 10 - Standard for Portable Fire Extinguishers
  - b. NFPA 13 - Standard for the Installation of Sprinkler Systems
  - c. NFPA 14 - Standard for the Installation of Standpipe and Hose Systems
  - d. NFPA 20 - Standard for the Installation of Stationary Pumps for Fire Protection
  - e. NFPA 22 - Standard for Water tanks for Private Fire Protection
  - f. NFPA 24 - Standard for the Installation of Private Fire Service Mains and Their Appurtenances
- xi. All components of the standpipe and hose systems shall be UL listed and labeled.
- xii. Material shall meet current ASTM and ANSI standards.
- xiii. Perform all tests and provide certification as required by authorities having jurisdiction.
- xiv. Confirm fire hose cabinet locations and quantities from both Architectural and Mechanical Drawings and provide higher count including piping connections. Report any discrepancies to Consultant prior to bid close.

- xv. Standpipe and hose systems shall be provided with all accessories as indicated in the drawings and as per the requirements of the local Japanese Authority and in accordance with NFPA 14.

XIII. **Pipe and fittings**

- i. All pipe work, valves and fittings, unless otherwise specified, shall comply with relevant clauses in the NFPA 14 regulations.
- ii. Underground piping shall be in accordance with NFPA 24.
- iii. Supply, deliver and install all pipe work materials and fittings for the standpipe and hose systems.
- iv. Pipe work shall follow the routes and approximate positions indicated on the drawings.
- v. Pipe work, ancillaries, valves and demountable joints shall be installed for convenient and safe routine maintenance and renewals.
- vi. Provide pipe hangers in accordance with NFPA 14.
- vii. All pipe work shall be installed with adequate gradients to facilitate draining and venting.
- viii. Pipe work shall be run in a neat manner and installed plumb, straight, symmetrical and at right angles to or parallel to adjacent walls.
- ix. No joints shall be formed in wall or floor thickness.
- x. All pipe work, fittings and valves shall be free from corrosion, scale and internal obstruction.
- xi. Pipe work ends shall be cut square reamed free from burrs and finished full bore.
- xii. Sufficient unions and flanged joints shall be provided to install and dismantle sections of pipe work, wherever difficulty in dismantling may occur and on straight runs of more than 25m.
- xiii. Unions or flanges shall be provided at all valves and equipment for easy dismantling. Connections to coils, pumps, and other equipment shall be made in such a manner as to eliminate undue strains in piping and equipment. Necessary fittings and bends shall be furnished to avoid springing of pipes during assembly.
- xiv. Care shall be taken in placing unions to allow freedom to spring apart. Unions and flanges shall not be placed in inaccessible positions. Where pipe work is installed in inaccessible places, a union or flange shall be installed, prior to the pipe passing into the wall or floor. Unions shall have two bronze conical seats ground in. Long screw connections will not be accepted.
- xv. All black mild steel pipe work in wall chases shall be welded throughout with flanged joints at 16 m maximum intervals if applicable.
- xvi. Manufacturer's standard fittings shall be used and fabricated fittings will not be accepted without approval.

- xvii. Bends and tees shall be of the easy sweep type, except at air vents, drain points and dead legs where square tees shall be used.
- xviii. Changes in diameter of horizontal pipe work shall be formed eccentrically.
- xix. Prior to any work being "covered up", the Contractor shall request the Engineer's approval to that part of the installation in question.
- xx. Pre-fabricated pipe work shall be in accordance with the relevant clauses.
- xxi. Take appropriate means to prevent galvanic action where dissimilar metals are connected.
- xxii. For working pressures below 20 bar the pipe work shall be seamless factory galvanized steel in accordance with ASTM A 53 grade B schedule 40.
- xxiii. Fittings on 50 mm and below shall be galvanized malleable iron fittings conforming to class 250, ANSI B16.4 and shall be UL listed, FM approved.
- xxiv. Fittings 65mm and above shall be factory galvanized mechanical roll grooved fittings and shall be UL listed, FM approved. These shall be class 250 to ANSI B16.9.
- xxv. For working pressures above 20 bar the pipe work shall be seamless factory galvanized steel in accordance with ASTM A 53 grade B schedule 80.
- xxvi. Fittings on 50 mm and below shall be galvanized malleable cast iron fittings conforming to class 300, ANSI B16.3 and shall be UL listed, FM approved.
- xxvii. Fittings 65mm and above shall be factory galvanized mechanical roll grooved fittings and shall be UL listed, FM approved. These shall be class 300 to class 16.9.
- xxviii. All valves and fittings used in the pipe work system shall not have a pressure rating less than that of the pipe work.
- xxix. Provide sleeves for each pipe passing through walls, partitions, and floors.
- xxx. Sleeves which are contained in walls, ceilings or floors which are fire barriers shall be additionally packed with a non-combustible material for the entire length to form a fire/smoke stop of the required fire rating.
- xxxi. The material shall be subject to approval and must comply with local Japanese Authority.
- xxxii. UL listed expansion joints shall be provided for all pipe work passing through any building expansion joint and where necessary as specified and are designed for use in fire protection piping systems.
- xxxiii. All piping shall be thoroughly cleaned of loose scale, dirt, etc., before installation. During the course of the installation, all open ends of pipes shall be plugged or capped to prevent ingress of dirt.
- xxxiv. After installation and sealing of joints all piping shall be thoroughly cleaned with clean water under pressure to the satisfaction of Engineer. Water samples test may be required if the Engineer is considered as necessary. Water used for this purpose shall be discharged as directed.

- xxxv. Underground piping supplying the system shall be flushed in accordance with NFPA 24.
- xxxvi. Any temporary pipe work and equipment necessary for the above cleaning shall be provided by the Contractor.

#### XIV. FIRST-AID HOSE REEL EQUIPMENT

- i. The Fire Hose Reel is designed for easy operation by one person and is ideal for ports, harbors and marinas. Constructed using a marine grade aluminum powder coated mounting stand, the reel can be easily installed on either a pontoon system or bolted directly to a secure foundation.
- ii. The reel itself is should be from stainless steel to BS-3169-Type-A/AS/NZS 1221 and contains 30M of 25mm textile braided reinforced UV stable thermoplastic hose. All valves and fittings are manufactured from brass and the twist to operate on/off jet nozzle delivers a smooth water jet of 6 metres, with an inlet pressure at the stop valve of 220kPa meeting all standard requirements of BS-3169-Type-A/AS/NZS 1221. A stainless-steel interlock mechanism is also provided for the retention of the hose nozzle which prevents the hose being run out without first opening the valve.
- iii. 1300mm marine grade aluminum powder coated mounting stand
- iv. Hose reel mounting plate Stainless steel pipe assembly
- v. Stop valve and connecting union
- vi. Stainless steel hose reel, red powder coated, BS-3169-Type-A/AS/NZS 1221
- vii. 30 meters of 25mm reinforced UV stable hose
- viii. Brass valves and fittings
- ix. Twist to operate on/off jet nozzle
- x. Interlock mechanism for hose nozzle
- xi. Operation instruction manual
- xii. Optional life buoy/floating throwing rope
- xiii. Optional manual call points
- xiv. Optional audio/visual alarm system
- xv. Optional hose reel covers.
- xvi. Where a fire hose reel pipe branch from a hydrant supply serves two or more fire hose reels or is larger than 25mm, it will be fitted with an isolating valve at the connection point into the fire hydrant service.
- xvii. Each fire hose reel main supply isolating valve will be secured in the open position by a padlocked metal strip or device and have attached an engraved non-ferrous metal tag with 8mm upper case letters:



**XV. FIRE HOSE REEL SERVICE – LOCK OPEN.**

Where practical, fire hose reel main supply valves will be located either external to the building or within a fire isolated stairway, passage or ramp.

**XVI. HOSE PIPES, BRANCH PIPES AND NOZZLES**

**i. Hose Pipes**

- a. Two numbers Hose Pipes shall be rubber lined woven jacketed and 63mm in dia. 15m long. They shall conform to type A (Reinforced rubber lined) of NFPA-14. The hose shall be sufficiently flexible and capable of being rolled.
- b. Each run of hose shall be complete with necessary coupling at the ends to match with the landing valve or with another run of hose pipe or with branch pipe. The couplings shall be of instantaneous spring lock type. This shall be conforming to BS.

**ii. Branch Pipes**

Branch pipe shall be of Gunmetal 63 mm dia and be complete with male instantaneous spring lock type coupling for connection to the hose pipe. The branch pipe shall be externally threaded to receive the nozzle.

**iii. Nozzle**

- a. The nozzle shall be of Gunmetal 20 mm in (internal) diameter. The screw threads at the inlet connection shall match with the threading on the branch pipe. The inlet end shall have a hexagonal head to facilitate screwing of the nozzle on to the branch pipe with nozzle spanner.
- b. End Couplings, Branch pipe, and Nozzles shall conform to BS.
- c. Two C.P hoses of 15m length with couplings shall be provided with each External (Yard) Hydrant. Two RRL hoses of length as per NFPA-14, as specified, with couplings shall be provided with each Internal Hydrant. One nozzle and one branch pipe with coupling shall be provided with each Yard Hydrant and Internal Hydrant.

**XVII. HOSE CABINET**

- a. The internal hose cabinet shall accommodate the Hose pipes, branch pipe, Nozzle First aid Hose Reel and Hydrant Outlets and shall be fabricated from 2 mm thick or 14 mm gauge MS/aluminum sheet. The overall size shall be 2100x900x715 mm, or as specified in the Architectural details. This shall have lockable centre opening glazed doors as per the requirement and as per Architectural details. Where the niche for wet riser is provided with shutters, separate hose cabinet as above may be dispensed with.
- b. The hose cabinet shall be painted red and stove enameled and words FIRE written in front glazed portion.

**XVIII. FIRE BRIGADE INLET CONNECTIONS**

- a. Fire Brigade Inlet connection shall be provided near the pump house and to the wet riser system as specified, for the following purposes:
  - i. Fire Brigade suction connection for fire static tank with provision of foot valve.
  - ii. Fire brigade inlet connection to fire static tank.
  - iii. Fire brigade inlet connection to the wet riser system. Each connection shall be provided with similar dia of Sluice valve and Non return valve.
  
- b. The locations of this Fire brigade connection shall be suitably decided with the approval of Consultant/Landscape Architect and with a view that these are easily accessible to the fire brigade, without any possible Hindrance.

**XIX. HYDRAULIC SIREN**

A siren shall be provided in the system, to indicate the flow of water in the wet riser system. Alternative arrangements may also be adopted. This shall be turbine type.

**XX. VALVE CHAMBERS**

- i. Contractor shall provide suitable Brick Masonry Chamber in cement mortar 1:5 (1 cement: 5 coarse sand) on cement concrete foundations 150 mm thick in 1:5:10 mix (1 cement: 5 fine sand: 10 graded stone aggregate 40 mm nominal size) 15 mm thick plaster inside and outside finished with a floating coat of neat cement inside with cast iron surface box approved by fire brigade including excavation, back filling complete.
- ii. Valve chambers shall be of following size:  
For depths 100 cm and beyond 90x90x100 cm

**XXI. PORTABLE FIRE EXTINGUISHER**

- i. Provide portable fire extinguishers in all areas in accordance with NFPA 10 and in compliance with local authorities having jurisdiction. Provide the following types of extinguishers in accordance with the schedule below.
- ii. Type 1: Provide in the Mechanical Rooms, UL listed, 5 kg multipurpose dry chemical extinguishers, stored pressure type having ammonium phosphate base with hose and shutoff nozzle integral shutoff nozzle labeled by Underwriters Laboratories.
- iii. Type 2: Provide in Transformer rooms and all electrical and telephone rooms, UL listed, chemical dry powder as shown on drawing, insulated handle, hose and horn discharge assembly, self-closing level squeeze grip operation, fully charged, labeled by Underwriters Laboratories with mounting brackets where required.

- iv. Type 3: Provide for other floor areas, UL listed, 5 kg multipurpose dry chemical extinguishers, complete with wall brackets for future mounting.
- v. Type 4: Provide for Parking areas, UL listed, 5 kg standard dry chemical type, fire extinguishers complete with mounting bracket.
- vi. Type 5: Provide for external plant areas UL listed, 2.5 kg CO2 fire extinguishers complete with insulated handle, hose and horn discharge assembly, self-closing lever squeeze grip operation and mounting brackets.
- vii. Provide extinguisher wall brackets type as recommended by extinguisher manufacturer for non-cabinet mounted fire extinguishers.
- viii. Provide recessed steel, extinguisher cabinets with lacquer finished doors, outside lettering and concealed hinges. Finish to be approved by architect. Exact size of cabinet shall be to suit extinguisher. Provide lettering on cabinet door to read Extinguisher.
- ix. Install portable fire extinguishers in cabinets for finished occupied areas or on brackets.
- x. Provide certification that each extinguisher has been properly charged, including:
  - xi. Date extinguisher was charged.
  - xii. Name of person who charged extinguisher and the name of his organization
  - xiii. Signature of person giving certification, and the name of his organization
  - xiv. Affix certification to each extinguisher tag provided in this Contract. Provide space for future service data entry.

## XXII. SPRINKLER HEADS

- i. Comply with General Requirements and all documents referred to therein.
- ii. Provide all labor, materials, products, equipment and services to supply and install sprinkler systems as indicated on the Drawings and specified in this Section of the Specification in accordance with NFPA 13 and to the requirements of local Japanese Authority.
- iii. The fire protection contractor shall be experienced in the design and installation of fire protection systems to NFPA standards and shall be an approved contractor local Japanese Authority.
- iv. Provide all necessary sprinkler heads in accordance with NFPA 13 to achieve a fully sprinkle red building.
- v. Sprinkler system piping shall be sized by hydraulic calculations in accordance with NFPA 13 and a complete set of calculations shall be submitted with the plans for engineer's review.
- vi. Submit system layout drawings, component shop drawings, specifications and hydraulic calculations for Consultants review prior to commencing installation.
- vii. Submittal data shall be reviewed and incorporate requirements of the local authorities. Drawings shall be certified correct and bear the contractors engineers certification prior to submission to the consultant.

- viii. Upon completion of the installation, modify the system calculations and submit hydraulic design data based on as-built system.
  - ix. Obtain all approvals before proceeding with the work.
  - x. Provide certificate of compliance that components are compatible and, where applicable, certified for intended use by recognized testing agency.
  - xi. Meet local building and fire regulations, including the most recent issue of the following:
    - xii. NFPA 13 - Standard for the Installation of Sprinkler Systems
    - xiii. NFPA 14 - Standard for the Installation of Standpipe and Hose Systems
    - xiv. NFPA 20 - Standard for the Installation of Stationary Pumps for Fire Protection
    - xv. NFPA 22 - Standard for Water tanks for Private Fire Protection
    - xvi. NFPA 24 - Standard for the Installation of Private Fire Service Mains and Their Appurtenances
  - xvii. All components of the sprinkler systems shall be UL listed and labelled.
  - xviii. Perform all tests and provide certification as required by authorities having jurisdiction.
  - xix. Refer final Architectural and Interior Designer Reflected Ceiling Plans and co-ordinate locations of sprinkler head with lighting and other ceiling mounted components. Co-ordinate sprinkler piping to avoid interference with all other services.
- XXIII. ALARM VALVE & AUTOMATIC WATER MOTOR GONG VALVE**
- i. Provide UL listed alarm check valve for sprinkler systems in accordance with NFPA 13 and with retarding device of approved design to obviate false alarms due to mains pressure variations where required and as shown on Drawings.
  - ii. Alarm check valves shall be complete with Water Motor Alarm Gong, all required auxiliary valves and drains and with pressure switch for wiring into the building fire alarm system.
  - iii. Alarm check valves shall be iron body bronze trim for minimum 175psig(12bar) working pressure complete with electric pressure switches, test and alarm bell connections. Pressure gauges and all other ancillaries
  - iv. Provide wiring from alarm check valves to fire alarm panel in accordance with NFPA 72.
  - v. **Water Motor Alarm**
    - a. The sprinkler system shall be fitted with an approved water motor alarm, which shall be located at a distance not exceeding 25m from the alarm valve, and at a height not to exceed 6m above the alarm valve.
    - b. The pipe work and fittings used shall be galvanized and in accordance with NFPA-13.

- c. The pipe work shall be arranged to drain through a fitting having an orifice not exceeding 3 mm in diameter. The orifice plate may form an integral part of the fitting but shall be manufactured from a non-ferrous material to prevent the hole from becoming blocked by corrosion or foreign matter.
  - d. A 15 mm test valve shall be installed on the installation side of each alarm valve.
- vi. Electric Alarm Pressure Switch**
- a. Provide UL listed electric alarm pressure switch in accordance with NFPA 13 and they shall be mounted on a vertical branch pipe at least 300 mm long.
  - b. The pressure switch shall be of the diaphragm bellows operated type, and shall be sufficiently sensitive to operate when only one sprinkler is discharging. The pressure switch shall be provided with volt free contacts to facilitate monitoring by a Building Management System, and wired to the main fire alarm panel.
- vii. Automatic Zone Check (Zone Control Valve) Assembly**
- a. Provide UL listed/FM approved automatic zone check (zone control valve) assembly for each sprinkler system zone as required and shown on the drawings in accordance with NFPA 13 and as per the requirements of local Japanese Authority.
  - b. Automatic zone check assembly shall have the followings components;
    - i. UL listed and FM approved butterfly valve shall be fitted with factory installed UL listed/FM approved tamper switch.
    - ii. UL listed and FM approved check valve.
    - iii. UL listed and FM approved water flow alarm switch for the size of the pipe in which it is installed as a paddle type water flow indicator and shall be fixed after the butterfly valve, on the main supply pipe and before any connection is taken off.
  - c. Inspector test and drain connections.
  - d. Dial pressure gauges suitable for the water pressures shall be fitted so arranged that it can be easily removed for testing and checking without shutting down the water supply.
  - e. Re-circulating Pump
- viii. Vane-type water flow monitoring switch (WFMS).**
- a. Electrical box enabling control of motor and monitor of WFMS, local / remote as required.
  - b. Wiring from butterfly valve temper switch and water flow alarm switch to the fire alarm panel shall be in accordance with NFPA 72.
  - c. When actuated they shall perform the following:
    - i. Test mode actuation: When activated in test mode, the pump shall circulate the water, within the sprinkler riser, around WFMS to stimulate

the flow of one sprinkler head in operation. The electrical box shall control and monitor, motor and WFMS respectively, as required.

- ii. Fire mode actuation: When fire occurs, the sprinkler burst and water starts flowing to control / extinguish the fire. This leads to flow equal to or more than one sprinkler through the WFMS actuating it. The fire alarm panel / flow monitoring panel performs monitors / controls required in the fire condition when the WFMS actuation signal reach them.
- d. They shall have following features in the system:
  - i. Insure the testing of WFMS as per the requirements NFPA 25 without activating the fire pump and opening of test/drain valve.
  - ii. Installed in such a way that the test shall be conducted from a central control room, through single push button and the individual WFMS status can be read from main fire alarm panel or separate flow monitoring panel.
  - iii. Have the future (contacts and relays) facilitating the connection to BMS, for automatic actuation, once in 3 months which records the status as required.
- ix. Drain Pipe**
  - a. All drain pipe from test valves and drain down points shall discharge over suitable and proper drain point and shall be discharged over a suitable gully.
  - b. Provide drain pipe and fittings in accordance with NFPA 13.
  - c. Pipe backflow preventer relief and drain connections to nearest floor drain.

#### **XXIV. SHOP DRAWINGS & specifications**

- i. The Contractor shall submit to the Consultant two copies of Shop Drawings for Fire Fighting works as an Advance Copy to the Engineer-in-Charge for approval before start of work. Subsequent to the approval of the shop drawings, the Contractor shall submit six copies of Shop Drawings for execution to the Engineer-in-Charge. Also the Contractor shall submit four copies of the Technical Specifications and Catalogues.
- ii. Shop drawings shall be submitted for the following conditions:
  - a. Structural supports/hanging/laying and jointing details for all types of pipes as required.
  - b. Fire Fighting layout plans as required and for any changes in the layout of Fire Fighting/Architectural drawings.
  - c. The Contractor can only commence the work after the approval of above documents by Consultant.

**XXV. WATER SUPPLY and FIRE FIGHTING PUMPS & EQUIPMENTS ETC. PUMPS AND WATER SUPPLY EQUIPMENT**

- i. Work under this sub-head consists of furnishing all labor, materials, equipment and accessories necessary and required to completely install pumping system for various water supply services and water treatment as per drawings, specified hereinafter.
- ii. Without restricting to the generality of the foregoing, the work of pumps and water treatment equipment shall include the followings:
  - a. Hydro pumps for Domestic water.
  - b. Hydro pumps for Irrigation water
  - c. Sump pumps for disposal of drainage.
  - d. Fire pumps.
  - e. Motor control panels, power and control cabling and allied electrical works.
  - f. Pipes, valves, accessories, hangers, supports, delivery and suction feeders and connection to proposed pipe work.

**XXVI. PUMP SET**

**Hydro Pneumatic System (Domestic Water Supply and Irrigation Pumps)**

- i. Domestic /irrigation water supply pumps shall be packaged type skid mounted hydro pneumatic system with fixed speed system. Complete system to be mounted on a common base frame.
- ii. Pumps shall be multistage, Monoblock vertical centrifugal pumps with stainless steel body and stainless steel impeller, stainless steel shaft and coupled to a TEFC electric motor by means of a flexible coupling. Each pump should operate a curve 10m below specified head.
- iii. Pressure vessel of non-corrosive FRP composite construction lined with NSF and/or FDA listed material, like high density polyethylene with fully replaceable polyurethane. Air cell burst pressure of minimum of 5 times the vessel operating pressure and cycle tested for 2,50,000 cycles. No. and capacity of Pressure Vessel As per manufacturer recommendation.
- iv. Pump and motor shall be mounted on a common M.S. structural base plate or as required as per site conditions.
- v. Each pump shall be provided with a totally enclosed fan cooled induction motor.
- vi. Each pumping set shall be provided with a 150mm dia or of suitable size gunmetal "Burden" type pressure gauge with gunmetal isolation cock and connecting piping.
- vii. Provide vibration-eliminating pads appropriate for each pump.
- viii. Provide rate of flow measuring meter with bypass arrangement with every set of pumps.
- ix. All water supply pumps shall be provided with mechanical seals.

- x. Pumps shall have Control Panel with programmable logic controller (PLC) for cyclic operation of pumps. Pump working sequence should change after every operation. Contractor overload relays and MCBs should conform to IEC 898 – 1995/ specifications. Blinking indications for pumps start, trip, low level trip, and health supply should be provided in the panel along with the ammeter & voltmeter. Control panel should also consist of cooling fan.

#### XXVII. SUMP PUMP

- i. Sump pumps shall be submersible type for lifting domestic sewage or muddy water/drainage. Pump with impeller of approved material shall be mounted on waterproof motor. The impeller shall be suitable for handling solids up to 46-100mm dia.
- ii. The pump shall automatically operate with high water level and stop at low water level in the sump by means of “Electronic Level Controller”, of the approved make.
- iii. The sump pumps shall be complete in all respect and shall be installed as per manufacturer’s requirement as shown in the drawing. All accessories shall be In-Built as per manufacturer’s specification.
- iv. Sump pumps are compact Monoblock dry motor submersible pumps for suitable rating, with non-clog free flow open impeller, minimum solid handling capacity up to 100mm for sewer & 40 for storm water . Suitable for operation on 415 volts + 5% -15%, 50 C/s A.C 3 phase supply, speed 960/1440R&M including oil chamber, guide wire for lifting & lowering of pump, M.S. galvanized lifting chain, duck foot bend.
- v. The above pump sets must be supplied complete with following accessories:
  - a. Complete piping 100mm dia common delivery up to 1.5m as shone in the drawing. (The pipe should be preferably heavy-duty GI)
  - b. Necessary valve i.e Butterfly valve on delivery/suction side and none return valves are on delivery side.
  - c. Necessary cable from pumps set to control panel.
  - d. Electrical switch panel having all necessary accessories & safety devices of standard specifications. (Panels with sump pumps near each sump as per site conditions)
  - e. Automatic built-up water level controller with necessary length of cable up to control panel.



**XXVIII. FIRE FIGHTING PUMPS**

**i. Electrically Operated Main Fire, Sprinkler and Jockey Pumps**

- a. Provide UL listed / FM approved horizontal split case pumps complete with drivers to the capacities indicated on drawings in accordance with NFPA 20 and to the requirements of the local civil defense.
- b. Fire pumps shall be capable of furnishing not less than 150% of rated capacity at not less than 65% of rated head. Shut off head shall not exceed 140% of rated head.
- c. Entire Fire pump unit shall be painted to red color before shipping.
- d. Pump's shaft shall be stainless steel with bronze sleeve.
- e. Bearings shall be replaceable type, bronze.
- f. Provide name plate with all relevant information.
- g. Provide a test valve header assembly complete with hose valves, caps and chains.

**ii. Motors for Electric Driven Pumps**

- a. Provide NEMA MG1, ODP squirrel cage induction motor in accordance with NFPA 20 and provide name plate with all relevant information. The Motor shall be UL listed open drip proof, standard efficiency with 1.15 service factor. The fire pump shall be directly coupled through flexible coupling to a horizontal electric motor.
  - b. The locked rotor current shall not exceed the values specified in NFPA 20.
  - c. Terminal and wiring of the motor shall be compatible with controller of the pump.
  - d. Fire pump accessories
  - e. Automatic air release valve.
  - f. Casing relief valve for electric motor driven pump
  - g. Suction and discharge pressure gauges for all pumps
  - h. Eccentric tapered suction reducer
  - i. Concentric discharge increaser
  - j. Flow meter
  - k. Main relief valve
  - l. Waste cone closed type
  - m. Electric Motor Driven Fire Pump Controller
- iii. The electric motor driven fire pump's controller shall be UL listed / FM approved and completely assembled and tested at the factory for electric motor driven fire pumps, primary resistance type, with auto transfer switch in accordance with NFPA 20 and have the following features:
- iv. Isolating means and circuit breaker
    - a. "Power on" Pilot lamp
    - b. "Pump running" Pilot lamp
    - c. "Power failure" Pilot lamp

- d. "Phase reversal" Pilot lamp
  - e. "Pump motor temperature alarm" Pilot lamp.
  - f. Volt free contacts to fire alarm system for Pump running, Power failure and Phase reversal.
  - g. Suitable for manual and automatic operation
  - h. Push buttons for starting and stopping the fire pump.
  - i. Push button for silencing alarm
  - j. Minimum run timer to prevent short cycling
  - k. Emergency run mechanical control
  - l. Pressure switch
  - m. Audible alarm
  - n. Voltmeter and ammeter on the front side of the panel.
  - o. Controller shall be suitable for wall mounting or freestanding type.
- v. Enclosure of the controller shall meet the requirements of NEMA 12, drip tight terminals of the controller shall be sized to suit the incoming power cables.
- vi. Air Vessel for Fire Pumps**
- a. Provide an air vessel fabricated from 10mm M.S. sheet with dished ends and suitable supporting legs, air vessel shall be provided with a 100mm dia flanged connection from pump, one 25mm dia drain with valve, one gunmetal water level gauge and 25mm sockets for pressure switches. The vessel shall be 450mm in dia and 2000 mm high and tested to 10.0Kg/cm<sup>2</sup> pressure.
  - b. The fire pumps shall operate on drop of 1 Kg/cm<sup>2</sup> pressure in the mains. The pump operating sequence shall be arranged in a manner to start the pump automatically but should be stopped manually by starter push buttons only.

**vii. Diesel Fire Pump**

**a. Scope**

This section covers the details of requirements of the standby fire pump, operated by a diesel engine.

**b. General**

The diesel pump set shall be suitable for automatic operation, complete with necessary automatic starting gear, for starting on wet battery system and shall be complete with all accessories. Both engine and pump shall be assembled on a common bed plate, fabricated from mild steel channel.

**c. Drive**

The pump shall be only direct driven by means of a flexible coupling. Coupling guard shall also be provided. The speed shall be 1450/1800 rpm.

**d. Fire Pump**

- i. The fire pump shall be horizontal split casing centrifugal type. It shall have a capacity to deliver as specified in specifications, developing adequate head so as to ensure a minimum pressure of 3.5 Kg. per cm<sup>2</sup> at the highest and the farthest outlet. The delivery pressure at the pump outlet shall be as per specifications. The pump may be single stage or multi stage as specified. The pump shall be capable of giving a discharge of not less than 150% of the Rated discharge at a head of not less than 65% of the rated head. The shut off head shall be within 120% of the rated head.
- ii. The pump casing shall be of cast iron to grade FG 200 to BS and parts like impeller shaft sleeve; wearing-ring etc. shall be of non-corrosive metal like bronze/brass/gunmetal. The shaft shall be of stainless steel. The pump shall be provided with mechanical seal.
- iii. The pump casing shall be designed to withstand 1.5 times the working pressure.
- iv. Bearings of pump shall be effectively sealed to prevent loss of lubricant or entry of dust or water.

**e. Diesel Engine**

- i. **Environmental Conditions** - The engine shall be required to operate under the conditions of environment as required as per site conditions.
- ii. **Engine Rating –**
  - a. The engine shall be cold starting type without the necessity of preliminary heating of the engine cylinders or combustion chamber (for example, by wicks, cartridge, heater plugs etc). The engine shall be multi cylinder/vertical 4 stroke cycle, water cooled diesel engine, developing suitable HP at the operating speed specified to drive the fire pump. Continuous capacity available for the load shall be exclusive of the power requirement of auxiliaries of the diesel engine, and after correction for altitude, ambient temperature and humidity for the specified environmental conditions as mentioned. This shall be at least 20% greater than the maximum HP required to drive the pump at its duty point. It shall also be capable of driving the pump at 150% of the rated discharge at 65% of rated head. The engine shall be capable of continuous non-stop operation for 8 hours and at least 3000 hours of operation before major overhaul. The engine shall have 10% overload capacity for one hour in any period of 12 hours continuous run.
  - b. The engine shall accept full load within 15 seconds from the receipt of signal to start. The diesel engine shall conform to B.S: 649 all amended up to date.
- iii. **Engine Accessories** - The engine shall be complete with the following accessories: -

- a. Fly sheet dynamically balanced.
  - b. Direct coupling for pump and Coupling Guard.
  - c. Radiator with hoses, fan, water pump, drive arrangement and guard.
  - d. Corrosion Resister
  - e. Air cleaner, oil bath type/dry type
  - f. Fuel service tank support, semi-rotary pump and fuel oil filter with necessary pipe work.
  - g. Pump for lubricating oil and lube oil filter
  - h. Elect. starting battery (2x12 v)
  - i. Exhaust silencer with necessary pipe work
  - j. Governor
  - k. Instrument panel housing all the gauges, including Tachometer, hour meter and starting switch with key (for manual starting).
  - l. Necessary safety controls
  - m. Winterization arrangement, where specified.
- iv. **Cooling System** - The engine cooling system shall be radiator water cooled system. The radiator assembly shall be mounted on the common bed plate. The radiator fan shall be driven off the engine as its auxiliary with a multiple fan belt. When half the belts are broken, the remaining belts shall be capable of driving the fan. Cooling water shall be circulated by means of an auxiliary pump of suitable capacity driven by the engine in a closed circuit.
- v. **Fuel System** –
- a. The fuel shall be gravity fed from the engine fuel tank to the engine driven fuel pump. The engine fuel tank shall be mounted either over or adjacent to the engine itself or suitably wall mounted on brackets at a height not less than 60 cm above the fuel injection pump. The fuel filter shall be suitably located to permit easy servicing.
  - b. All fuel tubing to the engine shall be with copper, with flexible hose connections where required. Plastic tubing shall not be permitted. The fuel tank shall be of welded steel construction (3mm thick) and of capacity sufficient to allow the engine to run on full load for at least 8 hours.
  - c. The tank shall be complete with necessary floor mounted supports, level indicator (protected against mechanical injury) inlet, outlet, overflow connections and drain plug and piping to the engine fuel tank. The outlet should be so located as to avoid entry of any sediment into the fuel line to the engine.
  - d. A semi rotary hand pump for filling the daily service tank together with hose pipe 5 mtr. long with a foot valve etc. shall also form part of the scope of work.

- vi. **Lubricating Oil System** - Forced feed lube oil system shall be employed for positive lubrication. Necessary lube oil filters shall be provided, located suitably for convenient servicing.
- vii. **Starting System** –
  - a. The starting system shall comprise necessary batteries (2x12 v), 24 volts starter motor of adequate capacity and axle type gear to match with the toothed ring on the fly wheel. By metallic relay protection to protect starting motor from excessively long cranking runs suitably integrated with engine protection system shall be included within the scope of the work.
  - b. The battery capacity shall be suitable for meeting the needs of the starting system.
  - c. The battery capacity shall be adequate for 10 consecutive starts without recharging with cold engine under full compression.
  - d. The scope shall cover all cabling, terminals, initial charging etc.
- viii. **Exhaust System** - The exhaust system shall be complete with silencer suitable for outdoor installation, and silencer piping including bends and accessories needed for a run of 5 meter from the engine manifold. (Adjustment rates for extra length shall also be given). The total back pressure shall not exceed the engine manufacturer's recommendation. The exhaust piping shall be suitably lagged.
- ix. **Engine Shut Down Mechanism** - This shall be manually operated and shall return automatically to the starting position after use.
- x. **Governing System** - The engine shall be provided with an adjustable governor to control the engine speed within 5% of its rated speed under all conditions of load up to full load. The governor shall be set to maintain rated pump speed at maximum pump load.
- xi. **Engine Instrumentation** - Engine instrumentation shall include the following:-
  - a. Lubricant oil pressure gauge.
  - b. Lubricant oil temperature gauge.
  - c. Water pressure gauge.
  - d. Water temperature gauge.
  - e. Tachometer.
  - f. Hour meter.The instrumentation panel shall be suitably resilient mounted on the engine.
- xii. **Engine Protection Devices** - Following engine protection and automatic shutdown facilities shall be provided: -
  - a. Low lube oil pressure
  - b. High cooling water temp.
  - c. High lube oil temperature

d. Over speed shut down.

- xiii. **Pipe Work** - All pipe line with fittings and accessories required shall be provided for fuel oil, lube oil and exhaust systems. Copper piping of adequate sizes shall be used for lube oil and fuel oil. M.S. piping will be permitted for exhaust.
- xiv. **Anti Vibration Mounting** - Suitable vibration mounting duly approved by Engineer-in-Charge shall be employed for mounting the unit so as to minimize transmission of vibration to the structure. The isolation efficiency achievable shall be clearly indicated.
- xv. **Battery Charger** - Necessary float and boost charger shall be incorporated in the control section of the power and control panel, to keep the battery under trim condition. Voltmeter to indicate the state of charge of the batteries shall be provided.

**f. CABLES**

- i. Contractor shall provide all power control cables from the motor control center to various motors, level controllers and other control devices.
- ii. Cables shall conform to BS and carry BS mark.
- iii. Wiring cables shall conform to BS.
- iv. All power and wiring cables shall be aluminum conductor PVC insulated armored and PVC sheathed of 1100 volts grade.
- v. All control cables shall be copper conductor PVC insulated armored and PVC sheathed 1100 Volt grade.
- vi. All cables shall have stranded conductors. The cables shall be in drums as far as possible and bear manufacturer's name.
- vii. All cable joints shall be made in approved manner as per standard practice.

**g. CABLE TRAYS**

Contractor shall provide M.S slotted cable trays at locations as shown on the drawings.

Cable trays shall be supported from the bottom of the slab at intervals of 60cms at both ends by anchor fasteners.

**h. EARTHING**

- i. There shall be an independent earthing station. The earthing shall consist of an earth tape connected to an independent plate made of copper or G.I. having a conductivity of not less than 100% international standard. All electrical apparatus, cable boxes and sheath/armor clamps shall be connected to the main bar by means of branch earth connections of appropriate size. All joints in the main bar and between main bar and branch bars shall have the lapping

surface properly tinned to prevent oxidation. The joints shall be riveted and sweated.

- ii. Earth plates shall be buried in a pit of 1.20x1.20M at minimum depth of 3M below ground. The connections between main bar shall be made by means of three 10mm brass studs and fixed at 100mm centers. The pit shall be filled with coke breeze, rock salt and loose soil. A G.I. pipe of 20mm dia with perforations on the periphery shall be placed vertically over the plate to reach ground level for watering.
- iii. A brick masonry manhole 30x30x30cm size shall be provided to surround the pipe for inspection. A bolted removable link connecting main bar outside the pit portion leading to the plates shall be accommodated in this manhole for testing.
- iv. Earthing of the system is required to avoid the shock during the use of the electrical equipment. A body earthing shall be provided to all the electrical equipment. A dedicated earthing shall be provided to ELV system, UPS system and other electrical equipment based on the local norms.

#### **i. CONTROL PANELS / STARTERS**

- i. Switch board cubicles of approved type shall be fabricated from 16-gauge M.S. sheet with dust and vermin proof construction. It shall be painted with powder-coated finish of approved make and shade. It shall be fitted with suitable etched plastic identification plates for each motor. The cubicle shall comprise of the followings:-
  - a. Incoming main isolation MCCB of required capacity.
  - b. Fully Aluminum taped Bus Bar of required capacity.
  - c. Isolation MCCB one for each motor.
  - d. Fully automatic as specified D.O.L/Star Delta starters suitable for motor H.P. with push buttons one for each motor and on/off indicating neon lamps. (DOL up to 7.5 HP and Star Delta from more than 7.5 H.P)
  - e. Single phase preventer of appropriate rating for each motor.
  - f. Panel type ampere meters one for each motor with selector switch.
  - g. Panel type voltmeter on incoming main with rotary selector switch to read voltage between phase to neutral and phase-to-phase.
  - h. Neon phase indicating lamps for incoming main and on/off indicating lamps for each motor.
  - i. Rotary switch for manual or auto operation for each pump (manual/auto off).
  - j. Fully taped separate aluminum bus bars of required capacity and with required outlets.
  - k. Space for liquid level controllers as specified + 1 extra space.
  - l. The panel shall be pre-wired with color-coded wiring. All interconnecting wiring from incoming main to switch gear, meters and accessories within the switchboard panel.

m. Provision of main incoming cables from the top of the panel.

- ii. All switch gears and accessories shall be of approved make such as “Siemens, Larsen & Toubro” or equivalent.
- iii. Switchboard cubicles shall be floor or wall mounted type as recommended by manufacturers. All floor-mounted switchboards shall rest on minimum 225mm high platform. The contractor shall provide the shop drawings for base and panels.

**j. VIBRATION ELIMINATORS**

Provide on all suction and delivery lines double flanged reinforced neoprene flexible pipe connectors. Connectors should be suitable for a working pressure of each pump. Length of the connector shall be as per manufacturer’s details.

**k. ILLUMINATED FACSIMILE ANNUNCIATOR PANEL**

**i. Scope**

Scope of this section comprises the supply, installation, testing and commissioning of illuminated facsimile annunciation panel.

**ii. Illuminated Facsimile Enunciator**

- a. Illuminated facsimile enunciator shall be provided with facsimile of the building, constructed of acrylic panels of suitable dimensions, showing the Basement, Ground floor plans and section showing the location of Zonal Panels on each typical floor, entry points, various facilities shown with enamels in various colors.
- b. Alarm lights to indicate fire location shall be arranged within the acrylic panel and shall be either automatically lighted by operation of any automatic fire detection devices or manual station, or by control of push button incorporated in the control desk.
- c. Indicator of each building or facility shall include two lamps connected in parallel and so arranged that the failure of either of the lamps is readily apparent when a call or test is made.
- d. Power for the Enunciator shall be supplied from the power supply for the control desk.
- e. Representation of the various plans/Drawings on the acrylic of the Enunciator shall be by negative film processing with colored Discrimination of various zones for which the drawings shall be furnished for approval.



**iii. WATER SOFTENER**

- a. Softener shall be designed to give zero commercial hardness. Softener shall be with cation exchange resins.
- b. Softener vessel shall be of mild steel plate with dished ends and self-supporting arrangement. Vessel shall be suitable for a working pressure. The shell shall have a minimum thickness of 8mm and dished ends 10mm. The vessel shall be painted internally with non-toxic bitumen paint and externally with one coat of red oxide and two or more coats of synthetic paint to give an even shade.
- c. The vessel shall have an internal collecting and distribution system of manufacturer's design.
- d. The softener shall have a set of interconnecting face piping consisting of inlet, outlet and brine injection system with valves and accessories complete as per requirement. Piping shall be M.S. medium duty, as per BS and valves shall be cast iron double flanged sluice valves on SOUNDERS pattern, with C.I. body and Neoprene rubber diaphragm (suggested make LABLINE, NKI or equivalent).
- e. One set of hydraulic injector with control valve, brine delivery pipes with adjustable indicator.
- f. One cylindrical salt saturator and measuring tank of M.S. rubber lined having a capacity of a minimum of two regenerations for.
- g. One orifice board for indicating wash and rinse rate to be fitted in drain sump.
- h. One charge of supporting gravel, sand and "cation" resin in requisite quantity. Resin shall be BS or approved equivalent make.
- i. One water testing kit with instructions for testing water samples.

**iv. PIPING**

- a. Pipes for suction and delivery shall be galvanized/M.S tube (heavy duty) confirming to BS. The M.S flanges shall confirm to BS.
- b. Gate valve and check valve above 65mm dia shall be C.I. double flanged conforming to BS manufactured by the reputed manufacturers or C.I. double flanged butterfly valves.
- c. Full way and check valves 65mm dia and below shall be gunmetal tested to 20Kg/cm<sup>2</sup> pressure certified and conforming to BS.
- d. Suction strainer or foot valves shall be C.I., confirming to BS.

**v. Joints**

Bolted bonnet, outside screw and yoke, wedge gate, iron body, bronze trim with flanged ends, threaded or grooved ends.

**vi. Testing**

All G.I pipes (except fire pipe) shall be tested hydrostatically for a period of 30 minutes to a pressure of 15 Kg/cm<sup>2</sup> without drop in pressure and all G.I pipes for fire shall be tested hydrostatically for a period of 30 minutes to a pressure of 15 Kg/cm<sup>2</sup> without drop in pressure confirming to NFPA-14.

**vii. GUARANTEE**

- a. The contractor shall submit a warranty for all equipment, materials and accessories supplied by him against manufacturing defects, malfunctioning or under capacity functioning.
- b. The form of warranty shall be as approved by the Engineer-in-Charge.
- c. The warranty shall be valid for a period of one year from the date of commissioning and handing over.
- d. The warranty shall expressly include replacement of all defective or under capacity equipment, Engineer-in-Charge may allow repair of certain equipment if the same is found to meet the requirement for efficient functioning of the system.
- e. The warranty shall include replacement of any equipment found to have capacity lesser than the rated capacity as accepted in the contract. The replacement equipment shall be approved by the Engineer-in-Charge.

**XXIX. TECHNICAL INFORMATIONS FOR WATER SUPPLY / FIRE FIGHTING PUMPS & EQUIPMENTS UNIT ETC.**

**(TO BE FILLED BY THE TENDERER)**

S.NO	PARTICULARS		Main Fire Pump	Jockey Pump
<b>(I).</b>	<b>ELECTRICAL OPERATED FIRE PUMP</b>			
<b>(A)</b>	<b>PUMP:</b>			
	1. Discharge	:		
	2. Total head at full discharge	:		
	3. Type	:		
	4. Make and Model No.	:		
	5. BHP absorbed	:		
	(a) at rated head and discharge			
	(b) at 150% of rated discharge and 65% of rated head.			
	6. Casing material.	:		

S.NO	PARTICULARS		Main Fire Pump	Jockey Pump
	7. Impeller material.	:		
	8. Shaft material.	:		
	9. No. of stages.	:		
	10. Type of drive.	:		
	11. Type of sealing.	:		
<b>(B)</b>	<b>MOTOR:</b>			
	1. Make.	:		
	2. Type.	:		
	3. Protection type.	:		
	4. Insulation class.	:		
	5. Electrical particulars (Voltage/No. of phase/frequency).	:		

S.NO	PARTICULARS		Main Fire Pump	Jockey Pump
	6.B.S conforming to	:		
	7. H.P. (App.)	:		
	8. Speed.	:		
<b>(II).</b>	<b>DIESEL FIRE PUMP</b>			
	<u>Diesel Engine:</u>			
	1. Make & Model No.	:		
	2. Type.	:		
	3. H.P.	:		
	4. Speed.	:		
	5. No. of cylinders.	:		
	6. BS Standard conforming to	:		
	7. Type of cooling.	:		

S.NO	PARTICULARS		Main Fire Pump	Jockey Pump
	8. Fuel consumption at full load.	:		
	9. Overload capacity.	:		
	10. Isolation efficiency.	:		
<b>(III).</b>	<b>HYDRO PUMPS (FOR DOMESTIC WATER)</b>			
<b>(A)</b>	<b>PUMP:</b>			
	1. Discharge.	:		
	2. Total head at full discharge.	:		
	3. Make and Model No.	:		
	4. Type.	:		
	5. Frame size.	:		
	6. BHP absorbed	:		

S.NO	PARTICULARS		Main Fire Pump	Jockey Pump
	(a) at rated head and discharge.	:		
	7. Casing material.	:		
	8. Impeller material.	:		
	9. Shaft material.	:		
	10. No. of stages.	:		
	11. Type of drive.	:		
	12. Type of seal.	:		
<b>(B)</b>	<b>MOTOR:</b>			
	1. Make.	:		
	2. Frame size.	:		
	3. Type.	:		
	4. Protection type.	:		

S.NO	PARTICULARS		Main Fire Pump	Jockey Pump
	5. Insulation class.	:		
	6. Electrical particulars (Voltage/No. of phase/frequency).	:		
	7. BS Standard conforming to	:		
	8. H.P.	:		
	9. Speed.	:		
<b>(IV).</b>	<b>SUMP PUMPS (FOR SEWAGE)</b>			
	1. Discharge	:		
	2. Head	:		
	3. Type	:		
	4. Solid Handling Capacity	:		
	5. H.P of Motor	:		



S.NO	PARTICULARS		Main Fire Pump	Jockey Pump
	6. Other Details	:		
<b>(V).</b>	<b>SUMP PUMPS (FOR DRAINAGE)</b>			
	1. Discharge	:		
	2. Head	:		
	3. Type	:		
	4. Solid Handling Capacity	:		
	5. H.P of Motor	:		
	6. Other Details	:		
<b>(VI).</b>	<b>ELECTRIC CONTROL PANEL</b>			
	1. Make	:		
	2. Make of switch fuse unit/breaker used.	:		
	3. Thickness of sheet metal used.	:		

S.NO	PARTICULARS		Main Fire Pump	Jockey Pump
	4. Make of contractors.	:		
	5. Make of cables and size of cables for different motors.	:		
	6. Any other information's.	:		
<b>Note:-</b>				
The Tenderer must give as maximum as possible information. They may add any other relevant information's also, if required.				

#### XXX. IMPORTANT INSTRUCTION FOR QUALITY OF WATER

The successful contractor will have to carry out a test of raw water from all the sources of water for the building at their own cost from a reputed lab as approved by the Engineer-in-Charge / Consultant. On the basis of these results the contractor has to submit his shop drawings, design calculations and specifications accordingly.

Please note that it is ultimately the responsibility of the contractor to provide treated water for different use in the building as per International Standard as given in the attached guidelines.

#### XXXI. LIST OF APPROVED MAKES

1) Following are the preferred makes for execution of works. All material should conform to BS Standard & CIDB compliant. Sample of materials / equipments in conformity with specifications, specification & applicable codes and standards shall be submitted along with technical data sheet for approval of the engineer.

2) The Engineer /Consultant/Client reserves the right to select any of the brands indicated in the list of preferred make. The tenderer shall quote his rates on the basis of price of best quality product of the brand/make stipulated in the items of works as described in specifications, specifications as well as in the list of preferred make. The contractor cannot

claim anything extra if the Engineer / Consultant/Client change the make equipment to the list of preferred make.

3) The Contractor can substitute with any equivalent make (after approval of technical sheet & specification) providing approval is sought from the engineer, However Final discretion lies with the engineer.

**Note: The Code given are indicative however the contractor before procuring & executing the work shall ascertain & determine the applicable Japanese codes, which are required to be complied with Osaka Japan, and only there after the respective material should be used.**

## 6 Chapter F

### ELECTRICAL WORK

#### 6.1 INSTRUCTION

**SUBJECT:** Proposed Electrical System for ITPO OSAKA JAPAN.

**INTRODUCTION:** It is proposed to Supply, Installation, Testing and Commissioning transformer, DG Set, Electrical Panel, Capacitor Panel, UPS, Automatic, Fire Detection Gas Suppression System, Electrical Work, Point Wiring, Distribution Board, Main & Sub main Cabling, Earthing, Lighting Protection system, Wi-Fi System, Fire Alarm, PA System, CCTV System, Light Fixture etc.

#### 6.2 TECHNICAL SPECIFICATION OF EQUIPMENTS

##### 208V / 110V DRY TYPE TRANSFORMER

#### 6.3 General

This document specifies the minimum requirements for Dry type transformers, the purpose of this specification is to set the minimum engineering standard for labor, materials and services required for the design, fabrication, inspection, testing and supply of Vacuum Cast Coil VCC Dry type Transformers including enclosure, auxiliary equipment and accessories, this specification is applicable up to 480V transformers

Specifications of Dry type vacuum cast coils (VCC) Transformers also known as Cast Resin Dry Type Transformers (CRT) for distribution and lighting applications. This section does not purport to include all the necessary provisions of a contract. For general requirements, like tests, erection, maintenance, and commissioning, please contact the purchaser.

It is not the intent to specify completely all details of design and construction of the equipment. However, the equipment shall conform in all respect to high standard of design, engineering and workmanship and be capable of performing in continuous commercial operations. Transformer shall be as per latest and relevant IEC / UL standards.

#### 6.4 Service conditions

- i. The transformer to be supplied against this specification shall be suitable for satisfactory continuous operation under the climatic condition prevailing at site and to be specified by the purchaser as per IEC / International Standard as under,

Location:

- a. Max ambient temperature (Deg.C): 50 Deg C
- b. Max. altitude above mean sea level (m): 1000

### **A. System characteristics**

Rated voltage: HV: As per the prevailing norms of electricity supply authorities  
LV: 208V/110V or as per the requirement

Note: Transformer sizing can be replaced as per actual site electrical load requirement.

Power ratings: 250 kVA

Frequency: 60 Hz

Number of phases: 3 Phase 4 Wire System

Rated voltage: HV: As per the prevailing norms of electricity supply authorities  
LV: 110V

Note: Transformer sizing can be replaced as per actual site electrical load requirement.

Power ratings: 2500 kVA

Frequency: 60 Hz

Number of phases: 3 Phase 4 Wire System

DG Set: 1010kVA

- ii. Operation other than the Rated Voltage and Frequency
- iii. Frequency: The standard frequency shall be 60 Hz with a tolerance of +/-3 percent.
- iv. Transformer will be with on line tap changer (OLTC)
- v. Transformer built in accordance with this specification may be operated at its rated kVA at any voltage within +/-10 percent of the rated voltage at that particular tap.
- vi. The transformer shall be capable of delivering rated current at a voltage equal to 105 percent of the rated voltage.
- vii. A transformer for two or more limits of voltage or frequency or both shall give its rated kVA under all the rated conditions of voltage or frequency or both; provided an increase in voltage is not accompanied by decrease in frequency.

### **B. Documentation**

With the commercial offer the bidder shall send the following documents:

- i. Technical datasheet
- ii. Preliminary Outline Drawing
- iii. Product Catalogue
- iv. Below Test reports of the transformer from any of the bidder's factory should be submitted:

- a. Fire Behavior Test: Class F1
- b. Climatic Behavior Test: Class C2
- c. Environmental Behavior Test: Class E2

**Prior to delivery of the equipment, the supplier shall submit to the owner the following information:**

- i. Definitive drawings
- ii. Operation and maintenance manual for transformers
- iii. Operation and maintenance manual for temperature control device
- iv. Rating plate drawing
- v. Connection diagram
- vi. Factory acceptance test reports: Routine test reports and Type / Special tests if any agreed prior to order

## **6.5 Design and construction**

### **A. Rated power**

The transformer shall be designed so that they can deliver continuously its rated current under steady loading conditions without exceeding the temperature rise, if the applied voltage is equal to the rated voltage and that the supply is at rated frequency.

### **B. Overloads**

Dry type AN cooled transformer, can be overloaded according to IEC 60076-12 Loading guide for dry type transformers.

### **C. Core assembly**

- i. The core shall be constructed of the best quality, low loss, cold rolled, grain oriented electrical steel laminations insulated on both sides with carlite. The core shall be Cruciform, stacked type and mitred laminations and shall be “step lap” overlapped to minimize core losses and noise.
- ii. The complete design of core must ensure permanency of the core losses with continuous working of transformers. The entire core assembly shall be protected with a required temperature rated heat retardant and rust resistant resin-based lacquer for corrosion protection before the coils are mounted. The assembled core shall be braced with structural steel. The core shall be supported to permit lifting of the core / coil assembly.
- iii. Prime grade of CRGO to be used:
  - a. CRGO Mother coil should be used for ordered transformer
  - b. Bill of lading / Invoice proof will be used for verification
  - c. CRGO core slitting and cutting to be witnessed during stage inspection, if required

#### **D. Windings**

- i. The transformer shall have separate high voltage and low voltage windings for each phase, coaxially mounted, high / low air space between coils shall be adequate for the rated voltage potentials and shall be separated by barrier. HV Windings shall be vacuum cast with Copper as conductor & 180 deg C (Class H) insulation system temperature. LV Winding should be of non-encapsulated design of Copper foil wound together with an insulating pre-impregnated B-Stage epoxy resin and thermally cured in an oven. Winding design shall be adequate to allow for full encapsulation with filled resin under Vacuum. The position of this mould shall be horizontal during the casting process that shall assure the total elimination of air bubbles that could create air cavities and critical points of partial discharges.
- ii. The insulation system of the windings shall meet the assigned temperature class i.e. Insulation Class H, rated 180 deg C insulation class, which shall be vacuum cast in epoxy resin mixture rated at 180 deg C.
- iii. The insulation level of the windings shall comply as per standard unless specified and agreed separately elsewhere:
- iv. **The Fire, Environmental, and Climatic classes should be applicable as per IEC 60076-11. Test certificate to be submitted by bidder.**
  - a. Environmental Class: It shall be E2, in order to be able to withstand condensation or pollution or combination of both.
  - b. Climatic Class: It should be C2:
    - i. C2: Outdoor installation. The transformer is suitable for operation, transport and storage at ambient temperatures down to – 25 deg C.
  - c. Fire Class: It shall be F1. Transformer subjected to fire hazard. Restricted flammability is required. Self-extinction of fire (poor burning is permitted with negligible energy consumption) shall take place within a specified time to be agreed between purchaser and manufacturer, unless specified by National Specification. The emission of toxic substances and opaque smokes shall be minimized. Materials and products of combustion shall be practically halogen-free and shall contribute with a limited quantity of thermal energy to an external fire.

#### **E. High Voltage Connections**

- i. The HV cable terminals will be made in copper material, located above the top of the connection bars. Each terminal will be drilled with a 13 mm hole ready for connection of cables. Connections between the primary side switchgear and transformer shall be bus bar, if required.
- ii. The HV delta connection will be made through copper tube / pipe protected by heat shrinkable tubing complying to the rated voltage.

#### **F. LV connections**

- i. The LV connections will be made from above onto bars located at the top of the coils on the opposite side to the HV connections. All the terminal connection bus bars shall have half round edges.
- ii. Connections between the transformer and secondary side switchgear shall be flexible bus braid. The same shall be in purchaser's scope.

#### **G. Short – Circuit Withstanding**

- i. The transformer shall be capable of withstanding, on any tapping, for two seconds (IEC value = 2 s), without damage, under service conditions, the thermal and mechanical effects of a short – circuit at the terminals of any winding.
- ii. The term “withstand” means “the unit will remain in place without separation of any parts from the device when subjected to the seismic forces specified.”

#### **H. Thermal insulation class**

- i. The insulation system temperature for HV and LV winding will be 180°C (class H). The average winding temperature rise for both HV (at rated tapping position) and LV windings at full load shall not exceed 125°C (class H) (over an ambient temperature equal to 40 deg C)
- ii. Thermal classification of insulation and permissible temperature rises should confirm to class 'H' as per IEC 60076-11.
- iii. The insulating material shall conform to the thermal class of Insulation specified above.

#### **I. Casting plant**

OEM should have Automated Vacuum Casting plant for manufacturing of casted coils for Dry type transformers.

#### **J. Off circuit tapping's**

- i. The manually operated off-circuit tap links shall be provided on the HV side with appropriate labels to show the link location. The inspection window shall be provided for viewing purpose such that tap link position is visible without opening the transformer enclosure.
- ii. Four, 2-1/2 percent full capacity taps in the primary windings, with two taps above rated voltage and two taps below rated voltage shall be provided. The Tap Changer shall be capable of carrying the full transformer short-circuit current without damage or contact separation.
- iii. Their position can be selected whilst the transformer is off circuit in deenergized condition. Taping selection shall be by means of bolted links. The tapping range shall be:
  - a. Plus 2.5% and 5%
  - b. Minus 2.5% and 5%
- iv. Tapping's with connection cables are not accepted.



**K. HV and LV windings assembly**

- i. The high and low voltage coils of each phase shall be supported and clamped by lower and upper supporting blocks, each having rubber expansion blocks for absorbing thermal expansion.
- ii. The position of the LV terminals shall be either at the opposite side of the HV terminals at the top or at the bottom of the transformer. The neutral bar terminal, if any, shall be at the same side as the LV phase terminal. An extra neutral connection shall be provided with the bushing.

**L. Earthing terminal**

Provision shall be made to connect external earthing at position close to the bottom the enclosure at two points. Earthing terminal shall be adequately dimensioned to receive the external earthing conductor / strip of the purchaser.

**M. Internal earthing arrangement**

All metal parts of the transformer except for the individual core laminations and associated individual clamping plates shall be maintained at same fixed potential. The bottom main core clamping structure shall be connected to the enclosure by copper cable.

**N. Surface treatment and Painting**

- i. The procedure being stated shall be applicable to the metallic parts of the transformer and enclosure.
- ii. The process of powder coating shall have three steps:
  - a. Pre-treatment
  - b. Masking
  - c. Powder coating and curing

**O. Pre-treatment:**

- i. Pretreatment shall have following steps. Threaded parts to be covered with suitable arrangement to avoid the loss of protective coating during pretreatment.
- ii. Either 9 tank processes as below:

**Sr. No. STAGE**

- a. Degreasing
- b. Water rinse in Running water
- c. Water rinse
- d. De-rusting
- e. Water rinse in Running water
- f. Water rinse
- g. Phosphating
- h. Water rinse in Running water
- i. Passivation

- iii. Or Blast with angular steel grit until the grade is reached, average rugosity Ra between 6 and 12  $\mu\text{m}$ .
- iv. After these steps component to be dried by using compressed air.

**P. Masking:**

Masking to be done as per the standard procedure of supplier. Adhesive tape to be used to mask the area and to be removed after curing of powder. Zinc rich paste to be applied on the masked area. All the threaded parts are to be masked with proper arrangement during pre-treatment and powder c6ng. If the protective coating on the threaded parts is removed during the process zinc rich paint to be applied on the threaded parts.

**Q. Powder coating and curing**

- i. After pre-treatment, component to be checked for
  - a. dust particles
  - b. powdery patches
  - c. Rust
  - d. Improper phosphating
- ii. Dust particles powdery patches to be wiped by a clean cloth. If rust, improper phosphating and oil are present, pre-treatment to be repeated. Powder flow of gun, earthing, voltage to be checked before starting powder coating. Compressed air used should be pure and moisture free and filtered suitably. Coatings to be applied to get required DFT. Virgin (new) powders to be used for coating on boxes and covers. Care to be taken to have uniform coverage at crevices, bends, mounts etc. After powder coating components are sent to curing oven. Components to be cured at 200°C for 15-20 minutes. After curing components to be checked visually for blisters, lumps Gaps etc. If found, they are to be rectified immediately. Uncovered areas to be stripped and re-coated.
- iii. **Double coat Powder coating thickness (for outdoor environment or indoor environment in saline and harsh atmospheres):**
- iv. For double coat powder coating, apply primer coat (containing Zinc) up to average 70 (+20/-10)  $\mu\text{m}$ . and component to be cured in oven and then apply polyester based Powder up to 80  $\mu\text{m}$ .as a finish coat and cured in oven.
- v. For all (external and internal) surfaces: Average 100-120 microns. At no place the thickness shall be less than 100 microns.

**R. Accessories**

- i. The transformers shall be equipped with all the accessories deemed necessary for proper operation by the manufacturer plus the ones specified in the specification. Additional available accessories shall be quoted as options.
- ii. Each transformer shall be fitted with following accessories
  - a. Inspection covers (if taps are available)
  - b. Off circuit links in the primary for voltage variations

- c. Terminal marking plate
- d. Two nos. earthing terminals
- e. Lifting lugs and haulage lugs / holes
- f. Winding temperature detectors (PT-100 sensors) with solid state type temperature scanner with digital read out and requisite sets of remote signaling contacts for alarm and trip operation. Minimum of 1 no. of winding temperature detector per phase shall be provided
- g. Under carriage with bi-directional rollers with locking and bolting devices.
- h. Marshalling / scanner box complete with all instruments, accessories and fittings as required for the transformer.
- i. Danger plate indicating "entry prohibited under energized condition" of the transformer.
- j. Surge Arresters: Provide distribution class metal oxide-type surge arrestors.
- k. Rating & diagram plate to include tap connection: Transformer shall have a rating plate of weather proof stainless-steel material placed in a clear position. Nameplate information as called for by IEC standards shall be provided. This includes:
  - 1. Type of transformer
  - 2. IEC codes must be stated
  - 3. Manufacturer's name
  - 4. Serial number
  - 5. Year of Manufacture
  - 6. Insulation Level
  - 7. Number of phases
  - 8. Rated power
  - 9. Rated frequency
  - 10. Rated voltage
  - 11. Rated currents
  - 12. Vector Group
  - 13. Impedance voltage at rated current
  - 14. Type of Cooling
  - 15. Total Mass
  - 16. Temperature-rise of windings

#### **S. Enclosures**

Dry type transformer shall be provided with suitable protective sheet steel housing. For outdoor installations, enclosure with protection degree of IP44 will be provided, which provide safety barrier against accidental live contact depending on the environment where the transformer is located.

The provision for suitable padlocking / door key locking facility shall be provided on the doors of enclosure for safety.

#### **T. Standard enclosure**

- i. The enclosure is made of bolt-on type sheets of steel of the bolt-on type with removable panels and supported from the transformer framework. Central front and rear handle panels will be provided for access to the tap changer. The enclosure shall

be made up of cold rolled cold annealed sheet steel with minimum sheet steel thickness of 2 mm.

- ii. Inlet-outlet of cables is situated at the bottom of the enclosure through aluminum gland plates to be machined by the customer or with bus duct flanges as mentioned earlier for close coupling between incoming and outgoing sections: Full-height, high voltage with either flange or terminal compartment. Full-height, low-voltage with either terminal compartment or busway flange.
- iii. Entire assembly shall be made insect and rodent proof by means of barriers or screens.
- iv. For indoor applications the sheet steel will be painted in grey color, RAL7035 with average 60 - 80  $\mu\text{m}$  powder coating thickness; At no place the paint thickness shall be less than 60 $\mu\text{m}$  powder coating thickness for indoor applications.
- v. For outdoors applications will be painted in grey color, RAL7035 with average 100 – 120  $\mu\text{m}$  powder coating thickness. At no place the paint thickness shall be less than 100  $\mu\text{m}$  powder coating thickness for outdoor applications.
- vi. If requested by the purchaser to meet the site floor loading requirements, the dry type transformer supplier / vendor shall supply the transformer without bi-directional roller.

**U. Provision for switching transient protection:**

- i. The transformer shall be designed and equipped to withstand voltage transients that are generated from fast switching devices such as Air circuit breakers. Fast transient over-voltages can occur when the circuit breaker interrupts the magnetizing current prior to its reaching a natural current zero. Such transients are often repeated several times with escalating peak value during one circuit breaker operation. also highlighted protection provisions for such unusual service conditions.
- ii. Transformers installed at sites require adequate protection against such transient over voltages.
- iii. Protection Methods
  - a. With winding varistors:

The preferred method to protect the transformer is the combination of internal design with strategic placement of varistors to prevent both transient over-voltage and voltage amplification due to resonance. This method of protection must be guaranteed by the manufacturer to work in any system configuration without the need to consider cable capacitances, proximity of switching devices, or other system characteristics. The preferred protection must be of completely dry equipment and guaranteed to be operational throughout the standard operational life expectation of the transformer. The preferred protection must also not affect the size of the transformer's outer dimensions.

- b. With RC Snubber circuits

The alternative protection method is to use an RC snubber circuit with control monitoring. A system study must be performed by an accredited firm to determine the design of the snubber circuit components for each transformer. The control monitoring must provide a relay alert

system to notify when the components have seen a significant number of interactions that replacement is recommended.

- iv. The transformer and auxiliary cooling equipment, if any shall be designed and constructed to minimize the audible noise generated with the transformer energized at rated voltage and with all auxiliary cooling equipment in operation. The acceptable noise level shall be in accordance with IEEE C57.12.01. The measurement procedure shall be as specified in IEC 60076-10.

#### **V. Losses**

The transformer losses as per standard.

#### **W. Packing**

Dry type transformers with / without Enclosure shall be wrapped with shrink film and covered by HDPE polybag to prevent damages/water ingress during transportation.

The Dry Type transformers should be dispatched fully assembled, unless until transport restrictions do not permit accept in case where customer accepts.

#### **X. Transport**

To lift the transformer, all four lifting lugs must be loaded uniformly with equal length straps of suitable length to avoid distortion to the top core clamping structure and system of core and coil supports.

#### **Y. Storage**

Dry transformers must be stored in a dry, well-ventilated room and covered with a plastic sheet. After a long storage period at extreme low temperatures or after a lengthy period of being de-energized in very humid surrounding, the transformers must be dried before putting back into service. Drying can be achieved by warm air heaters or by industrial dehumidifiers.

#### **Z. Installation**

- i. After packing materials and any other blocking means used during transport are removed, the transformer should be cleaned and dusted-off, taking special care of the air cooling ducts between the windings and between the low voltage coils and the magnetic core. Once in final position ensure that the transformer is secured by blocking the rollers. The installation location should be well ventilated.
- ii. Suitable proper air circulation should always be ensured around the transformer during operation.
- iii. If the Dry Type transformer is required for outdoor installation, then the same shall be specified by customer in initial specifications.
- iv. Before the putting in service of the transformer, all electrical connections must be checked (incl. the tapping link connections). A poor electrical connection will cause unnecessary heating, resulting in possible damage to the transformer insulation.

#### **AA. Inspection**

The equipment shall be subject to inspection and testing during manufacture and after completion by one representative from the Buyer. All the expenses for travel,

accommodation, visa, etc. of the representatives in connection with the inspection, shall be borne by the Buyer. Acceptance by Buyer's representative of any transformer shall not relieve the manufacturer from any of this performance guarantee, or from any of the other obligations resulting from this contract.

#### **BB. Tests and test certificates**

The transformer shall be subjected to all the routine, type, and special tests as per IEC 60076: Part 11 as agreed upon between the purchaser and the manufacturer. Dry Type Transformers as per latest standard.

#### **CC. Routine Tests**

Routine tests as listed in IEC 60076.1 shall be carried out on every transformer and component:

1. Measurement of winding resistance according to IEC 60076-1
2. Measurement of voltage ratio and check of phase displacement according to IEC 60076-1
3. Measurement of short circuit impedance and load losses according to IEC 60076-1
4. Measurement of no load-loss and current according to IEC 60076-1
5. Separate-source AC withstand test according to IEC 60076-3
6. Induced AC withstand voltage test according to IEC 60076-3
7. Partial discharges measurement according to IEC 60076-11
8. Measurement of insulation resistance according to IEC 60076-1

#### **DD. D. G. SET**

##### **I. INTENT OF SPECIFICATION:**

This specification covers the design, manufacture, assembly, shop testing, packing, dispatch, transportation supply, testing, commissioning, performance and guarantee testing of **Diesel Gen-Sets or Gas Gen sets as per local guidelines**, complete in all respects with all equipment, fitting and accessories for efficient and trouble free operation as specified here under.

##### **II. CODES AND STANDARDS:**

The equipment furnish under this specification shall conform to the latest standard

##### **III. ENGINE:**

Diesel Engine shall be stationary, compression, ignition, totally enclosed, radiator cooled, stroke cycle, cold battery starting, turbo charged and after cooled 1800 RPM in accordance to specification complete with all accessories.

**IV. COOLING SYSTEM:**

Radiator Cooled with Acoustic Enclosure Outdoor Type.

**V. FUEL SYSTEM:**

Fuel System shall have Direct Injectors, Fuel filters, Self-contained piping & houses, complete piping.

**VI. LUBRICATING SYSTEM:**

Lubricating system shall have engine mounted lube oil pump, strainer, lube oil cooler, oil filter, By-pass filter, self-contained piping.

**VII. AIR INTAKE SYSTEM:**

Air intake system shall have dry type filter, Air intake manifold with necessary connections, Turbocharger with after cooler.

**VIII. EXHAUST SYSTEM:**

Exhaust system shall have Exhaust Manifold, Flexible piping, Hospital silencer to limit the noise level and extending silencer outside the canopy.

**IX. STARTING SYSTEM:**

Starting system shall have Starter 24V with suitable ampere capacity, Charging Alternator with inbuilt regulator 24 V minimum 30 AMP DC or as per battery capacity, Connecting links between battery & alternator. The engine shall be suitable for black start.

**X. MAIN AND BIG END BEARING:**

The main and big end bearing shall be detachable shells of high grade bearing material, and shall be pre finished. The dimensions of big end bearings shall be such that the connecting rods can be withdrawn through the cylinder liners.

**XI. COUPLING ARRANGEMENT:**

Coupling arrangement shall have Flexible coupling, Flywheel, Flywheel Housing, Coupling Guard.

**XII. INSTRUMENT PANEL:**

Instrument Panel shall be compatible for remote connectivity and shall have-

- Lube oil pressure gauge
- Water temperature gauge
- RPM Indicator & Hour Meter
- Battery charger ammeter
- Starting switch with key

**XIII. SAFETY CONTROL TRIP:**

- Low Lube oil pressure
- High Water temperature
- Engine over speed.

**XIV. ALTERNATOR:**

Standard	:	
Output	:	Self-excited, self-regulated foot mounted fitted with ball and roller bearings. This shall give full output at 40 deg. C.
Power factor	:	0.8
Rated Generating Voltage	:	3 phase 4 wire systems.
Voltage regulation	:	+/- 1.0% all load between no load to full load & power factor 0.8 to unity. AVR shall be mounted in alternator.
Frequency	:	60 HZ
Speed	:	1800 RPM
Overload Capacity	:	10% for one hour in any 12 hours of operation without exceeding temperature rise limits specified in BS: 2613 when corrected to ambient temperature at site
Class of Insulation	:	H and temperature rise limited to class H
Winding connection	:	Star connection (all six leads will be brought out of stator frame).
Termination termination	:	Termination box shall be amended to match bus duct arrangement.



The alternator shall be self-excited, self-regulated, self-ventilated in brush less for suitable automatic voltage regulator and shall conform to BS: 2613 or equivalent standard and shall give rated output at NTP conditions and shall be directly coupled with engine mounted on common rigid fabricated steel base frame with suitable ant vibration isolation system.

**XV. OTHER ACCESSORIES:**

**A. FUEL TANK:**

Day service fuel tank shall be made of 3mm thick MS sheet of 250 litres capacity for each set with all accessories such as inlet pipe connection, outlet pipe connection, through to collect split oil, air vent pipe with air filter, and manhole with cover with all fittings interconnections between tanks. The tank shall be provided with suitable calibration scale. Socket for level controller for automation purpose to be provided with dead plug. As applicable in the laws of Japan.

**B. BASE FRAME:**

M.S. Fabricated adequately machined base frame complete with lifting, facilities pre-drilled foundation holes suitable for permanent installation on foundation shall also be supplied. The base frame shall be manufactured with steel and shall be stress relieved. Manufacturer shall specify what measures are taken to reduce the stresses.

**C. BATTERIES**

For electrical control ckt of 24V D.C. of suitable ampere hour complete with battery charger, leads etc with M.S. Base & stand and shall be placed inside canopy.

**D. FUEL SYSTEM:**

The engine shall be capable of running on High Speed Diesel fuel oil. The fuel consumption of the engine at full, three quarters and half of its rated power output shall be indicated by the Contractor in the bid.

**E. SILENCER:**

Exhaust silencer shall be residential type to reduce the noise level.

## **XVI. COOLING:**

The diesel engine shall be radiator cooled.

### **A. ENGINE GOVERNER:**

The governor shall be Electronic type suitable for class A-1. This shall control the generator frequency, and shall be suitable for operation as per the selected battery voltage (24 V DC). Governor shall be capable to maintain zero speed rate or regulation and shall be A-1 type as per BS: 5514 in order to take care of heavy motor starting. It shall have necessary characteristics to maintain the speed substantially constant even with sudden variation in load. However, a tripping shall be provided if speed exceeds maximum permissible limit.

### **B. TURBO CHARGER:**

It shall be of a robust construction, suitable of being driven by engine exhaust having a common shaft for the turbine and blower. It shall draw air from filter of adequate capacity to suit the requirements of the engine.

### **C. STARTER BATTERY:**

The battery shall be maintenance free type.

### **D. ENGINE SAFEGAURD:**

- a. Safeguards shall be provided and arranged when necessary to stop the engine automatically by the following:
  - b. Energizing a solenoid coupled to the stop lever on the fuel injection pump rack.
  - c. De-energizing the "fuel on" solenoid
  - d. Energizing the "fuel - cut off" solenoid.
  - e. If any of the door opens.
  - f. The operation of the safeguard shall at the same time give individual warning of the failure by illuminating an appropriate local visual indicator and remote alarm at generator panel.
  - g. The contactors, relays and other devices necessary for signal and control, for above purposes shall be provided at Generator panel.
  - h. At the set at a easily accessible place an "EMERGENCY STOP" mushroom head stay put type P.B shall provided to stop the set in emergency mode.
  - i. The safe guard to "STOP THE SET" shall stop the set irrespective of mode selection of the set viz Auto, Manual or test for following cases, with simultaneous isolation of alternator ckt.
  - j. Emergency stop P.B's operation
    - Over speed.
    - Low lube oil pressure.

## **XVII. MANDATORY SPARE PARTS:**

The list of mandatory spares to be submitted by the contractor to owner along with bid.

### **A. PIPING WORK (D.G. FLUE GAS EXHAUST SYSTEM)**

#### **I. SCOPE OF WORK**

The scope of this section comprises supply, installation, testing & commissioning of D.G. Flue Gas Exhaust System pipes & pipe fittings etc. as detailed below in specifications. All pipes and fittings etc. shall conform to relevant codes & norms as applicable in Osaka Japan.

#### **II. D.G. FLUE GAS EXHAUST PIPING**

- a. D.G. Flue Gas Exhaust Pipe shall be "Medium" Class "B" M.S. Black pipes up to 150 mm and MS ERW Black Pipes above 150 mm Grade 330 with latest amendments.
- b. All piping and their steel supports shall be thoroughly cleaned and primer coated before installation.

#### **III. PIPE FITTINGS**

- a. The pipe fittings for screwed piping shall be malleable iron and for piping with welded joints shall of weldable quality. Also the fittings shall be suitable for same pressure ratings as for the piping system.
- b. All bends up to sizes 150 mm dia shall be ready made of heavy duty wrought steel of appropriate class.
- c. All bends in sizes 200 mm and above shall be fabricated from the same dia and thickness of pipe in at least four sections and having a center in radius of at least 1.5 times diameter of pipes. Fittings such as tees, reducers etc. shall be fabricated from the same pipe and its length shall be at least twice the diameter of the pipe.
- d. The dead ends shall be formed with flanged joints & shall have 6mm thick blank between flange pair for 150 mm and over.

#### **IV. FLANGES**

- a. All flanges shall be of mild steel & shall be slip on type welded to the pipes. Flanged thickness shall be to suit Class II pressure.
- b. Flanged pair shall be used on all such equipment's which are required to be isolated or removed for service.

### **B. PIPING INSTALLATION**

- i. The drawings attached with this tender indicate schematically the sizes, location of pipes & vertical shafts. The contractor, on award of the work, shall prepare detailed shop drawings based on tender drawings, showing the cross-section, longitudinal sections, details of fittings and all pipe supports.

- ii. Piping shall be properly supported on, or suspended from, stands, clamps, springs, hangers as specified and as required at site. The contractor shall adequately design all the brackets, saddles, anchors, clamps and hangers and shall be responsible for their structural sufficiency. A set of piping support calculations shall be submitted for structural engineer review and approval before site installation wherever critical & required.
- iii. Pipe supports shall be of steel, adjustable for height and primer coated with rust preventive paint and finish coated black. Where pipe and clamps are of dissimilar materials, a gasket shall be provided in between. Spacing of pipe supports shall not exceed the following:

Pipe Sizes	Spacing Between Supports	Rod Size
Up to 12 mm	1.2 Meter	8 mm
15 to 25 mm	1.8 Meter	8 mm
32 to 150 mm	2.4 Meter	10 mm
Above 150 mm	-----As Per Approved Shop Drawing-----	

- iv. Vertical pipes passing through floors shall be plumb and parallel to wall. Pipes shall be supported on all floors. MS cleats shall be welded on pipes and rest on MS channel placed on the floor with 15 mm thick resistoflex pads between the cleat and channel. U clamps with resistoflex sheet shall be provided to keep the pipe in position.
- v. T heading in exhaust piping shall be avoided.
- vi. Pipe sleeves at least 3 mm thick, 50 mm / 100 mm larger in diameter than exhaust pipes respectively shall be provided wherever pipes pass through retaining wall and slab. Annular space shall be filled with fibre glass and finished with retainer rings welded on the ends of the sleeve. All pipes passing through the retaining wall shall be provided with suitable water proofing compound.
- vii. Wherever pipes pass through the brick or masonry / slab openings, the gaps shall be sealed with fire sealant.
- viii. The Contractor shall make sure that the clamps, brackets, clamp saddles and hangers provided for pipe supports are adequate. Piping layout shall take due care for expansion and contraction in pipes and include expansion joints where required.
- ix. All pipes shall be accurately cut to the required size in accordance with relevant BIS Codes, edges beveled and burrs removed before laying. Open ends of the piping shall be closed as the pipe is installed to avoid entrance of foreign

matter. Where reducers are to be made in horizontal runs, eccentric reducers shall be used for the piping to drain freely. In other locations, concentric reducers may be used.

**C. ELECTRICAL PANEL**

**I. GENERAL**

Electrical shall be metal clad totally enclosed, rigid, floor mounting, air insulated, cubicle type for use on 110 volts, 3 phase, 60 Hz 4 wire system. Equipment shall be designed for operation in high ambient temperature and high humidity tropical atmospheric conditions. The panel manufacturer shall be strictly from the approved brand in approved list of make and shall have automatic cnc turret punch, cnc bending and he should have inhouse facility for 9 tank pre treatment and powder coating facility.

**II. STANDARDS AND CODES**

Updated and current Indian Standard Specifications and Codes of Practice will apply to the equipment and work covered by scope of this contract.

Low Voltage switchgear Assemblies IEC 61439 1 & 2

Low Voltage switchgear & control gear IEC 60947

Part I : General rules

Part II : Circuit Breakers

Part III : Switches, disconnectors, switch disconnectors  
and fuse combination units

Part IV : Contactors and Motor starters

Part V : Control circuit devices and switching elements

Degree of Protection of Enclosures for low voltage switchgear IEC60529

Seismic Withstand Level IEEE693

Internal arc IEC 61641

**III. SWITCHBOARDS**

**General**

1. LV Switchboards shall be certified by 3<sup>rd</sup> party Certification body as per IEC 61439-1, Test reports without certificate shall not be considered admissible proof of compliance. The Certifying Authority shall be qualified under ISO/IEC 17065 as per IEC 61439-1.
1. IEC 61439 Certificate to be made available for all ratings of LV Switchboards as mentioned in Schedule of Quantities or Single Line Diagram for this project.

2. LV switchboards and associated equipment including switchgear, control gear, Busbar supports, Busbar orientation, Busbar links etc. shall be identical in construction to assembly which has undergone Certification as per IEC61439-1, 2.
3. Certified design of switchboards shall be proven design from OEM (Original Equipment/ Switchgear Manufacturer). OEM name should be mentioned on top of each column of switchboard. Also, OEM Partnership Certificate shall be furnished by Panel builder.
4. To ensure installation consistency during switchboard life cycle, installation system, switchgears, motor starter components and metering devices must be supplied by the same Manufacturer (OEM).
5. Switchboards shall have a short circuit withstand capacity of minimum of 50 kA for time duration of 1s (Icw rating). The enclosures shall be designed to take care of normal stress as well as abnormal electro-mechanical stress arising due to short circuit conditions.
6. Switchboards shall have Rated Impulse withstand voltage (Uimp) of 22kV for withstanding against transient Overvoltage's, for which the values of clearances are referred
7. All covers and doors provided shall offer adequate safety to operating persons and provide ingress protection of IP42 unless otherwise stated. Ventilating openings and vent outlets, if provided, shall be arranged such that same ingress protection of IP 4X is retained.
8. Switchboards shall be tested for Internal arc withstand of 50kA for 0.3sec. The test should be performed for arc starting place - at Horizontal busbar, Vertical busbar and in outgoing cable compartments.
9. To ensure right performance on Seismic risk, Switchboards shall be validated design for Seismic withstand for Ground Acceleration level of 2g. Test shall be performed in accordance with standard IEEE 693 : 2018.
10. Switchboards must have mechanical impact level of IK10 level
11. In order to facilitate access within the switchboard for maintenance, its covering panels must be dismountable on all surfaces for all IP degrees
12. To ensure maximum protection of people around the electrical installation, front plates must be installed in front of all control and protection equipment in order to avoid direct access without a tool to the devices and consequently to the live parts.
  
13. For safety reasons and especially when the door is open during switchboard operation, all busbars must be covered by Metallic barriers over whole perimeter of the busbar zone. IP2X (touch proof) protection shall be available.
14. As specified in the BOM the switchboard shall be form 3b. For forms of separation to be achieved, only metallic covers shall be used. Hylem/ PVC sheets shall not be allowed.
15. To enhance Sustainability, LV Switchboards shall have Green Premium Certification, with eco production, with product design in accordance with RoHS & REACH directives and with End of Life Instructions.
16. The switchboard shall be supplied with a smartphone/web-based maintenance tracking system. A unique identifier shall be employed for each switchboard to enable quick access to switchboard details including but not limited to switchboard drawings,

wiring diagrams, list of spares, Switchboard BOM etc. A maintenance schedule shall be provided by the manufacturer for switchboard and major components inside. There should be a provision to enable alerts for upcoming maintenance activities for the switchboard and components. The alerts shall be automated and provided to the maintenance staff appointed by the End-user in the form of smartphone notifications.

#### **D. Switchboard Configuration**

1. The Switchboard shall be configured with Air Circuit Breakers, MCCB's, MCB's, Motor Starter components, Metering devices and other equipment as called for in the schedule of quantities.
2. Switchboard Configuration shall be generated by a Software/ Tool available from OEM, to ensure compliance to OEM panel design.
3. The MCCBs shall be arranged in multi-tier formation whereas the Air Circuit Breakers shall be arranged in Single Tier or Two-Tier formation to facilitate operation and maintenance.
4. The Switchboards shall be of adequate size with a provision of spare space to accommodate possible future additional switch gear

#### **E. Constructional Features**

1. Switchboards shall be metal clad totally enclosed, floor mounted free-standing type of modular extensible design suitable for indoor installation.
2. Switchboards, panels and cubicles shall be fabricated with CRCA Sheet Steel of thickness, same as that of tested assembly according to IEC61439-1 & 2. Sheet thickness for Load bearing frame structures shall not be less than 2.0 mm and shall be folded and braced as necessary to provide a rigid support for all components. Also, the doors and covers shall be fabricated from CRCA sheet steel of thickness not less than 1.6 mm.
3. All panels and covers shall be properly fitted and square with the frame. The holes in the panel shall be correctly positioned.
4. Panel shall be supplied with a double door arrangement. Global Door/ Front Door shall be fitted with transparent Glass to allow maintenance staff to visually access device status, meter readings, indicating lamp status without opening the door. IP level & Mechanical impact performance of the panel shall not be compromised in any scenario and shall remain at IP42/54 and IK10 level respectively, in all conditions.
5. Global door shall be provided with Ergonomic handles with locking (key RONIS n° 405).
6. The painting of the sheet metal shall be done by electrostatic spraying of epoxy resin powder to give smooth finish to the equipment. Color used shall be RAL 7047 for the enclosure and RAL 9022 for the functional units.
7. The switchboards shall be designed for use in high ambient temperature upto 45 degree centigrade and humid tropical conditions suitable for pollution degree 3.
8. Switchboards shall be made up of requisite vertical sections, which when coupled together, shall form continuous switchboards.
9. Switchboard shall be readily extensible on both sides by addition of vertical sections after removal of the end covers.

10. Each vertical section shall be provided with a rear or side cable chamber housing the cable end connections and power/control cable terminations. There should be availability of ample space for ease of installation and maintenance with adequate safety for working in one vertical section without coming into contact with any live parts. The design of the switchboard shall allow standard extension chambers if required to accommodate cables.
11. Some switchboards may be required to be installed against the wall, for such applications, documented designs shall be available.
12. Incomer and bus section panels or sections shall be separate and independent and shall not accommodate any outgoing feeder. The incomer panel shall be suitable for receiving bus trunking or LV cable of size specified.
13. Switchboards construction shall employ the principle of compartmentalized and metallic segregation for each circuit.
14. All the devices must be installed onto dedicated mounting plate designed for one or several switchgears of the same type. The objective of this point is to group protection equipment of the same type, as well as distinguish inside the switchboard the function of each device or group of devices and avoid identification mistakes.
15. Gaskets between all adjacent units and beneath all covers shall be provided to render the joints dust and vermin proof to provide a degree of protection of IP 42/IP 54 as stipulated in schedule of quantities. The unused openings within the switchboards shall be closed using suitable grommets.
16. Special care to be taken to ensure effective earthing of the frame and doors of the switchboards

**F. Switchboard Dimensional Limitations**

1. The overall height of the switchboard shall be limited to 2000 mm for all the Busbar ratings and type of switchboards. Panel should have integral base frame of 75 or 100mm,
2. Height for the operating handle, push buttons etc. shall be restricted between 300 mm and 1800 mm from finished floor level.



#### **G. Switchboard Compartmentalization**

1. Switchboard design shall be completely compartmentalized with separate compartments for horizontal busbars, vertical busbars, Cable alleys and functional units consisting of ACBs, MCCBs or Motor Starter Components.
2. Earthed metal or insulated shutters shall be provided between draw out and fixed portion of the switchgear such that no live parts are accessible with equipment drawn out. Degree of protection within compartments shall be at least IP 2X and that for Switchboard shall remain at IP 4x/5x.
3. For all Circuit Breakers separate and adequate compartments shall be provided for accommodating instruments, indicating lamps, control contactors and control MCB etc. These shall be accessible for testing and maintenance without any danger of accidental contact with live parts of the circuit breaker, busbars and connections.
4. Each switchgear cubicles shall be fitted with label in front and back identifying the feeder details. All device shall be mounted such that they can be operated from the front.
5. Separate cable compartments running the height of the switchboard in the case of front access boards shall be provided for incoming and outgoing cables.
6. Cable compartments shall be of adequate size for easy termination of all incoming and outgoing cables entering from bottom or top. The construction shall include necessary, adequate and proper support shall be provided in cable compartments to support and clamping the cable in the cable alley/ cable chamber.

#### **H. Switchboard Bus Bars**

1. Busbars shall be made of high conductivity, and high strength Copper. Busbars shall be of rectangular cross sections, with 10mm thickness, better suitable for full rated current for phase busbars and half/ full rated current for neutral busbar or as stipulated in schedule of quantities. Busbar shall be suitable to withstand the stresses of fault level as specified in schedule of quantities.
2. The maximum temperature of the busbars shall not exceed 90 degree Centigrade
3. The bus bar system may comprise of a system of Main Horizontal bus bars and Vertical Distribution bus bars running in bus bar chamber on either side of Switchgear chamber, so that busbars could be accessed with front access itself.
4. Design of LV Switchboard shall be such that, Phase and Neutral busbars should be together in same compartment. Also, the Neutral busbar shall always be in front to ensure safety, even when covers are open.
5. For ratings upto 1600A, design of LV Switchboards shall be such that Main Horizontal Busbar can be assembled at Top or at Bottom of Switchboard, to achieve less footprint, depending on site conditions viz. Cable Entry from Top/ Cable Entry from bottom etc.
6. The bus bars carrying full current of Switchboard shall be supported on non-breakable, non-hygroscopic epoxy resin or glass fiber reinforced polymer insulated supports that are Thermoset in nature, so as to able to withstand high operating

temperature of 135 deg C and mechanical forces, arising from a severe fault level as stipulated in schedule of quantities.

7. To ensure ability to resist ignition & to self-extinguish when ignited, Insulated supports shall be supplied from OEM only & confirm to Glow Wire Test.
8. The Busbar Support and the spacing should be same as per the type tested assembly.
9. Clearances & Creepage distances between phases shall be in line with IEC61439.
10. Continuous earth bus sized for prospective fault current to be provided with arrangement for connecting to site earth at two ends of Switchboard.

#### **I. Switchboard Interconnection**

1. All connection and tap offs shall be through adequately sized connectors appropriate for fault level at location. This shall include tap off to feeders and instrument/ control transformers.
2. For Functional units having ratings upto 160 Amps, PVC insulated copper conductor wires of adequate size to carry full load current shall be used. The terminations of such interconnections shall be crimped. Solid connections shall be used for all rating of 200 Amps & above.
3. All connections, tapings, clamping, shall be made in an approved manner to ensure minimum contact resistance. All connections shall be firmly bolted and clamped with even tension. Before assembly joint surfaces shall be filed or finished to remove burrs, dents and oxides to maintain good continuity at all joints.
4. All screws, bolts, washers shall be zinc plated. Only 8.8 grade nuts and bolts shall be used for Assembly of panels & also for busbar connections.

#### **J. Testing at Works**

- i. Copies of routine tests carried out at the Panel Builder's workshop shall be furnished along with the delivery of switchboards. Switchboard shall be inspected at Panel Builder's workshop prior to dispatch to site to witness the followings -
  - a) Physical variation and dimensional check
  - b) Verification of bill of material
  - c) Functional check
  - d) HV test
  - e) IR test
  
- x. Main LT Panels, IP  $\geq$  31 non-forced air ventilated, shall be enabled with a DIN rail wireless sensor capable of monitoring the system and generate three-levels of alerts on overheating wire connections or overheating cables depending on the severity of the detected situation.

- xi. Each column of the electrical switchboard shall include one wireless sensor at the top, to help user to prevent electrical switchboards from being damaged, by analyzing gas and particles in the air and sending alerts before any smoke or insulator browning occurs.
- xii. Sensor shall be able to analyze gases and microparticles inside the switchboard, by concentrating air into the sensor (with the help of an aspiration fan), applying a smart algorithm to sort internal cable issues from overheating, and sending alerts via email or notification to a smart phone application, enabling the switchboard's digital management.
- xiii. Temperature and humidity inside the switchboard should be measured by the wireless sensor and values to be communicated through the network.
- xiv. Sensor device should be able to be tested during commissioning and within the first 30 minutes after powering on. Device can also be tested whenever needed, after the 8-hour environment-learning period. All testing shall be made with an accessory provided only by the sensor manufacturer. Device shall also be capable to run self-diagnosis and provide two types of results.
- xv. Wireless sensor for early detection of overheating wire connections or overheating cables, should fulfill ISO 14025 PEP ecopassport® program requirements
- xvi. Sensor device should not replace any fire protection device of the installation.

**K. AIR CIRCUIT BREAKER**

**TYPE AND CONSTRUCTION**

- i. The ACB shall conform to the requirements of IEC 60947-2 shall be type tested & certified for compliance to standards any accredited international lab. The circuit breaker shall be suitable for 208 V  $\pm$  10%, 60 Hz supply system. Air Circuit Breakers shall be with molded housing flush front, draw out type and shall be provided with a trip free manual operating mechanism or as indicated in drawings and bill of quantities with mechanical "ON" "OFF" "TRIP" indications.
- ii. Air circuit breakers shall have a rated operational voltage of 208V AC (60Hz) & impulse voltage of 12 kV.
- iii. The construction of circuit breakers shall be as per pollution degree 4 requirements to sustain harsh environments
- iv. The tests shall be carried out with a breaking performance during operation (Ics) and admissible short time withstand (Icw) equal to the ultimate breaking capacity (Icu). i.e. Icu = Ics = Icw = 50KA for 1 Sec.
- v. The Circuit Breaker shall have minimum mechanical life of 10000 operations without maintenance.

- vi. The breakers shall deliver an electrical life of 6000 operations up to 2000A & 5000 operations for ratings 2500A and above under rated voltage of 208V AC, without maintenance.
- vii. All 4 Pole ACBs shall have fully rated neutral equal to rating of the breaker & shall be protected against over-load & short-circuit with provisions for settings at:
  - a. 4P 3d - neutral unprotected,
  - b. 4P 3d + N/2 - neutral protection at  $0.5I_n$ ,
  - c. 4P 4d - neutral protection at  $I_n$  to ensure precise neutral protection.
- viii. Shunt trip and closing coil shall be of continuous rated design and both should be accessible from the front of ACB after opening the cover, without disturbing any other part/release.
- ix. The Circuit Breaker shall have minimum 4 changeover auxiliary contacts rated at 10 A. There should exist, facility to add one more set of 4 contacts as required.
- x. Ready-to-close contact shall exist for indicating that all safety parameters are checked & enabling closure of breaker, ensuring at-most safety for the user.
- xi. The withdrawable circuit breaker shall have the following three distinct and separate positions, which shall be indicated on the face of the panel.
  - a. "Service" -- Both main and auxiliary circuits are connected.
  - b. "Test" -- All auxiliary circuits are connected & main circuits are disconnected.
  - c. "Isolated" -- Both main and auxiliary circuits are disconnected.
- xii. There should be a positive locking at these positions while racking out or racking in for clear & confirmative indications as the position is reached. A release push button shall be available to release the lock.
- xiii. A door interlock shall be provided so that it shall not be possible to open the door until the air circuit breaker moving part is in the disconnected position.
- xiv. The racking handle shall be stored on the air circuit breaker in such a manner as to be accessible without defeating the door interlocking.
- xv. The Circuit breaker protection shall be through intelligent ET range of electronic trip system suitable to protect the distribution network, against LI (Over load, Instantaneous), LSI (Overload, Short-Circuit & Instantaneous) & LSIG (Overload, Short-Circuit, Instantaneous & Ground fault).
- xvi. The circuit breaker control unit shall be with display. The trip units with display shall be suitable to measure current and voltage parameters.
- xvii. Control unit shall have fault history data & store last 5 trip causes.
- xviii. The trip unit shall have following protection settings, based on the type of trip unit.
  - a. Adjustable over load current ( $I_r$ ) settings from 40% to 100% of rating of ACB ( $I_n$ ).

- b. Over load time setting (tr) from 0.5s, 1s, 2s, 4s.....24s as field selectable curves
- c. Short circuit setting (I<sub>sd</sub>) from 1.5 to 10 times of I<sub>r</sub> setting
- d. Short circuit time delay adjustable from 0 to 400 msec.
- e. Instantaneous (I<sub>i</sub>) protection with an adjustable pick-up and an OFF position.
- f. Earth fault setting adjustable in absolute Ampere with time delay settings from 0 to 400 ms.
- g. ACB Shall have Inbuilt Zone selective interlocking.

#### **L. PROTECTION**

The protection release shall have following features and settings:

##### **(i) TRUE RMS SENSING**

The release shall sample the current at the rate of 16 times per cycle to monitor the actual load current waveform flowing in the system and shall monitor the true RMS value of the load current. It shall take into account the effect of harmonics also.

##### **(ii) THERMAL MEMORY**

When the breaker shall reclose after tripping on overload, then the thermal stresses caused by the overload if not dissipated completely, shall get stored in the memory of the release and this thermal memory shall ensure reduced tripping time in case of subsequent overloads. Realistic Hot/Cold curves shall take into account the integrated heating effects to offer closer protection to the system.

##### **(iii) DEFINED TIME – CURRENT CHARACTERISTIC**

A variety of pick-up and time delay settings shall be available to define the current thresholds and the delays to be set independently for different protection zones thereby achieving a close-to-ideal protection curve.

##### **(iv) TRIP INDICATION**

Individual fault indication for each type of fault should be provided by LEDs for faster fault diagnosis.

#### **SAFETY FEATURES**

- (i) The safety shutter shall prevent inadvertent contact with isolating contacts when breaker is withdrawn from the Cradle.
- (ii) It shall not be possible to interchange two circuit breakers of two different thermal ratings. For Draw-out breakers, an arrangement shall be provided to prevent rating mismatch between breaker and cradle.
- (iii) There shall be provision of positive earth connection between fixed and moving portion of the ACB either thru connector plug or sliding solid earth mechanism. Earthing bolts shall be provided on the cradle or body of fixed ACB.

- (iv) The incoming panel accommodating ACB shall be provided with indicating lamps for ON-OFF positions, digital voltmeter and ammeter of size not less than 96 mm x 96 mm, selector switches, MCB for protection circuit and measuring instrument circuits.
- (v) It shall be possible to bolt the draw out frame not only in connected position but also in TEST and DISCONNECTED position to prevent dislocation due to vibration and shocks.
- (vi) Draw out breakers should not close unless in distinct Service/Test/Isolated positions.
- (vii) The insulation material used shall conform to Glow wire test as per IEC60695.
- (viii) The ACB shall provide in built electrical and mechanical anti-pumping.

#### **M. TESTING**

Testing of each circuit breaker shall be carried out at the works as per relevant IS Code of Practice and the original test certificate shall be furnished in triplicate. The tests shall incorporate at least the following.

- i. Impulse withstand test.
- ii. Power frequency withstand test.
- iii. Short circuit test.
- iv. Temperature - rise test under rated conditions.

#### **N. MOULDED CASE CIRCUIT BREAKER**

##### **GENERAL**

- i. Moulded Case Circuit Breakers shall be incorporated in sub distribution boards wherever specified. MCCB's shall conform to IEC 947-2 in all respects. MCCB's shall be suitable either for single phase AC 120 volts or three phase 208 volts. All MCCB shall be provided with rotary operating mechanism.
- ii. All MCCBs shall be suitable for 3 Phase 208 Volts AC 60 HZ supply.
- iii. All MCCBs shall have rated service breaking capacity (Ics) equal to the ultimate breaking capacity (Icu) at defined operational voltage.
- iv. All MCCBs shall clearly indicate the suitability for isolation in the name plate identified by the symbol .
- v. All MCCBs shall offer class –II front face i.e. main current path of the circuit breaker should be isolated from auxiliary section
- vi. All MCCBs shall have cross bolted termination.
- vii. All MCCBs above 250A shall have the following features
  - a. Single frame size with common accessories to reduce inventory

- b. Microprocessor trip unit
  - c. Adjustable overload settings – 0.5-1 In
  - d. Adjustable Short circuit – 2-10 Ir
  - e. Adjustable neutral for 4P MCCBs – 0-0.5Ir-1Ir
  - f. Thermal memory
  - g. Test connector to check the healthiness of trip unit
  - h. 4000 electrical operations
  - i. ON/OFF/Trip/Push to trip indication contacts
- viii. All MCCBs up to 250A shall have following features
- a. Single frame size with common accessories to reduce inventory
  - b. Thermal magnetic trip unit
  - c. Adjustable overload settings – 0.7-1 In
  - d. Fixed short circuit settings
  - e. Fully rated neutral for 4P MCCB
  - f. 10000 electrical operations
  - g. ON/OFF/Trip/Push to trip indication contacts
- ix. **Individual fault trip LED indications** shall be available on all types of trip units for easy & faster identifying the cause of fault.
- x. **I<sup>2</sup>t ON / I<sup>2</sup>t OFF** options shall be available for short-circuit & earth fault protections to enhance discrimination with downstream devices.
- xi. The trip unit shall have integral test facility to verify the healthiness and to avoid external calibration.
- xii. The release shall be self-diagnostic type with clear LED indication in case of malfunctioning.
- xiii. It shall be possible to change the **protection settings on line** and the circuit breaker need not be switched off while adjusting the setting.
- xiv. Circuit breakers shall conform to Electromagnetic compatibility tests (EMC) as specified in IEC 60947-2, Appendix F.
- xv. Manufacturer shall submit the test certificates for the same.
- xvi. The control unit shall have **thermal memory** throughout the range to store temperature rise data in case of repetitive overload or earth fault for protecting the cables and loads.

#### **O. RUPTURING CAPACITY**

The Moulded Case Circuit Breaker shall have a minimum fault breaking capacity (Ics) of not less than 50KA RMS at 208 volts or as specified in specifications./ Drawing.

#### **TESTING**

Test certificate of the MCCB as per relevant Japanese Standards (JS) shall be furnished. Pre-commissioning tests on the sub distribution boards incorporating the MCCB shall be done as per standard.

**P. MEASURING INSTRUMENT FOR METERING**

I. GENERAL

The specifications herein-after laid down shall also cover all the meters, instrument and protective devices required for the electrical works. The ratings, type and quantity of meters, instruments and protective devices shall be as per the bill of quantities.

II. DIGITAL AMMETERS

Digital Ammeters shall be confirm to relevant IEC standard. It shall be digital type 7 segment LED display. Ammeter shall be suitable for accuracy class 1.0 and burden 0.2 VA approx. The ammeters shall be capable of carrying sustained overloads during fault conditions without damage or loss of accuracy. The meter shall be suitable for working in ambient temp 0 degree to 50 degree and 95% humidity condition.

III. DIGITAL VOLTMETERS

Digital Voltmeters shall be confirm to relevant IEC standard. It shall be digital type 7 segment LED display. Voltmeter shall be suitable for accuracy class 1.0 and burden 0.2 VA approx. The range for 3 phase voltmeters shall be 0 to 110 volts. The meter shall be suitable for working in ambient temp 0 degree to 50 degree and 95% humidity condition. The voltmeter shall be provided with protection MCB of suitable capacity.

IV. CURRENT TRANSFORMERS

Current transformers shall be in conformity with relevant IEC standard in all respects. All current transformers used for medium voltage applications shall be rated for 1KV Current transformers shall have rated primary current, rated burden and class of accuracy as required. However, the rated secondary current shall be 15A unless otherwise specified. The acceptable minimum class of various applications shall be as given below.

Measuring : Class 1.0

Protection : Class 5 P20

- i. Current transformers shall be capable of withstanding without damage, magnetic and thermal stresses due to short circuit fault of 50KA on medium voltage system. Terminals of the current transformer shall be marked permanently for easy identification of poles. Separate CT shall be provided for measuring instruments and protection relays. Each C.T. shall be provided with rating plate.
- ii. Current transformers shall be mounted such that they are easily accessible for inspection, maintenance and replacement. The wiring for CT's shall be copper conductor, PVC insulated wires with proper



termination lugs and wiring shall be bunched with cable straps and fixed to the panel structure in a neat manner.

V. CONTROL SWITCHES

- i. Control switches shall be of the heavy duty rotary type with escutcheon plates clearly marked to show the operating position. They shall be semi-flush mounting with only the front plate and operating handle projecting.
- ii. Indicating lamps shall be of the LED type, and with translucent lamps covers. Bulbs & lenses shall be easily replaced from the front.
- iii. Push buttons shall be on the momentary contact, push to actuate type fitted with self-reset contacts & provided with integral escutcheon plates marked with its functions.

VI. CABLE TERMINATION

- i. Cable entries and terminals shall be provided in the sub distribution boards to suit the number, type and size of aluminium conductor power cable and copper conductor control cable specified.
- ii. Provision shall be made for top or bottom entry of cables as required. Generous size of cabling chambers shall be provided, with the position of cable gland and terminals such that cables can be easily and safely terminated. Cable glands shall be brass compression type, barriers or shrouds shall be provided to permit safe working at the terminals of one circuit without accidentally touching that of another live circuit.
- iii. Cable risers shall be adequately supported to withstand the effects of rated short circuit currents without damage and without causing secondary faults.

VII. CONTROL WIRING

All control wirings shall be carried out with 1100V grade single core PVC cable having stranded copper conductors of minimum 1.5 sq. mm for potential circuits and 2.5 sq. mm for current transformer circuits. Wiring shall be neatly bunched, adequately supported and properly routed to allow for easy access and maintenance. Wiring shall be identified by numbering ferrules at each end. All control fuses shall be mounted in front of the panel and shall be easily accessible.

VIII. TERMINAL BLOCK

Terminal blocks shall be 500 Volts grade of the stud type. Insulating barriers shall be provided between adjacent terminals. Terminals block shall have a minimum current rating of 10 Amps and shall be shrouded. Provisions shall be made for label inscriptions.

IX. LABELS

Labels shall be of anodized aluminium, with white engraving on black background. They shall be properly secured with fasteners.

X. MISCELLANEOUS

Push buttons shall be of the momentary contact, push to actuate type fitted with self-reset contacts & provided with integral escutcheon plates marked with its functions.

XI. BATTERY AND BATTERY CHARGER

A set of 24V DC power supply shall be provided for indication, relay operation etc. for Main L.T. Panel. DC Power supply shall be sealed maintenance free batteries of suitable capacity. Suitable battery chargers shall also be provided to charge the battery to perform during mains failure.

XII. CAPACITOR BANK PANEL

Medium Voltage Capacitors and Control Panel to be used for improvement of power factor of the electrical system and shall be connected to Main L.T. Panels through L.T. Cable. Automatic Power Factor Correction Panel shall function to improve power factor of the system in which it is connected. It shall improve power factor up to 0.99 from existing value.

XIII. CODES AND STANDARDS-

Unless otherwise specified the capacitor and control panel shall conform to following standards IEC-61439 & IEC-61921.

XIV. SUBMITTALS

a. SHOP DRAWING AND TECHNICAL DATA

Complete technical data sheet including guarantee details giving the temperature rise, capacitor losses etc, Capacitor panel GA drawing, indicating mounting of capacitor units shall be furnished with the shop drawing.

b. SPECIFICATION

CAPACITORS

- i. The capacitor shall be MPP type 3 phase capacitor suitable for 208 Volt, 60 Hz,.
- ii. The temperature rise above the specified ambient (50°C) of any part of the capacitor and polyurethane resins associated equipment shall not exceed.

- iv. 25/10/5 KVAR capacitor units shall be used to form a bank of capacitors of desired capacity. All these units shall be connected in a parallel by means of solid bus bars of adequate current carrying capacity. The combination of capacitor unit shall be such as not to exceed permissible over voltage across the healthy capacitor units in case of failure of one or more units. Capacitor banks shall be suitable for operation at 110% of rated RMS voltage and 150% of rated RMS current. Each unit shall satisfactorily operate at 135% of rated KVAR.

- v. Construction-

The Capacitor banks shall be floor mounting type using minimum floor space. The container of capacitors shall be hermetically sealed in sturdy containers made out of 2 mm thick M.S. sheet steel. Dry type or synthetic non-inflammable oil shall be used for insulation. Each standard unit shall be provided with a built in silvered fuse.

- vi. Discharge Resistance

Each capacitor unit shall be individually protected by MCCB with indication to show when it is in operation. The capacitors shall be provided with permanently connected discharge resistors so that residual voltage of the capacitors shall be reduced to 50 Volts or less within one minute after the capacitor is disconnected from the sources of supply.

- vii. Earthing

Two separate earthing terminals shall be provided for earth connection for each bank. All components and frame shall be properly earthed.

#### XV. CONTROL PANEL

The panel shall be provided with necessary MCCB's, contactors, automatic required steps relays with associated CT's and power factor meter, indicating lamps, push buttons etc. Capacitors shall also be housed in the same panel. The panel shall be free standing type, dead front cubicle and shall be constructed from 2 mm thick sheet steel. The degree of protection shall be IP-4X. This panel shall be integrated with the main L.T. panel unless specified otherwise.

#### XVI. PAINTING

As the capacitor panel is integrated with Main LT panel, it shall be painted as per specification in relevant Clause above.

XVII. UPS

SYSTEM COMPONENTS

IGBT technology (IGBT Rectifier & IGBT Invertor) with galvanic isolation transformer.

XVIII. POWER

On-Line UPS

XIX. PRODUCT CERTIFICATION/TESTING

The product shall have certification from any one of the following -

- a) ERTL
- b) ETDC
- c) STQC
- d) I E C
- e) ISO 9001

XX. OPERATING TEMPERATURE

0 - 40 degree Centigrade

XXI. HUMIDITY

Up to 95%

XXII. OUTPUT FREQUENCY

60 Hz +/- 0.01% Hz

XXIII. WAVE FORM

Pure Sine Wave

XXIV. TRANSIENT RESPONSE

+/- 1% maximum under following conditions:

- a) Loss or Return of Input AC supply
- b) 100% step load

XXV. RECOVERY TIME

To nominal voltage in less than 10 milli second.

XXVI. EFFICIENCY (OVER ALL)

Minimum 90% at full load.

XXVII. LOAD POWER FACTOR

0.9 lag to unity.

XXVIII. CREST FACTOR

Greater than 2.5

XXIX. MTBF

Minimum 100000 hrs.

XXX. SWITCH OVER TIME

Zero

XXXI. OVERLOAD RATING

110% for 30 minutes

125% for 10 minutes

150% for 1 minutes

XXXII. NOISE

Less than 68 dB at 1 mtr. For 100% Load

XXXIII. SWITCHING SPEED

Minimum 2 KHZ

XXXIV. INDICATION

Mains ON/OFF, /Battery HIGH/LOW, Battery ON, Invertor ON/TRIP, O/P HIGH/LOW, Battery HIGH/LOW, Alarm for Battery Discharge.

XXXV. PROTECTION

Input - Over/Under voltage, Over Current.

Battery - Over/Under Voltage, Over Current, Battery Low Alarm/Trip.

Output - Over/Under Voltage, Over Current.

Output - Short Circuit Over Temperature DC Over Current

XXXVI. CONTROL CIRCUITORY

Microprocessor based control circuitry be provided and all indications will be digitally displayed using microprocessor-based software.

XXXVII. METERING

Digital display with multifunctional key panel indicates.

Output Voltage/Current

DC Voltage/Current

Output Frequency

XXXVIII. COMMUNICATION PORT

RS 232

XXXIX. DIAGNOSIS & CONFIGURATION SOFTWARE

Compatible with Unix/Windows.

XL. OUT LOOK

Compact size with aesthetically good look (specifies the size and weight)

XLI. UPS FAILURE

During failure in the UPS equipment the static switch automatically transfers the A.C. load directly to the AC. line in less than 1/4 cycle so that transfer does not affect critical equipment operation.

XLII. HARMONIC DISTORTION OF WAVE FORM

Total harmonic distortion (THD) should be below 2% for linear load and below 3% for nonlinear load.

XLIII. MAINTENANCE BY PASS SWITCH

The portion of UPS module used to connect the alternator supply to critical load while electrically isolating static switch and inverter for maintenance purpose.

XLIV. BATTERY DISCONNECT SWITCH

The switch used to electrically isolate the storage batteries from UPS module.

XLV. STATIC TRANSFORMER SWITCH

The switch senses an inverter shutdown signal or degradation of inverter output item. It shall automatically transfer the loads from one inverter to the alternative AC power without interruption.

XLVI. RETRANSFER TO INVERTOR

The static transfer switch shall be capable of automatically retransferring the load back to inverter after the inverter has returned to normal voltage and stabilized for period of time.

XLVII. QUALITY ASSURANCE

The manufacturer shall have quality assurance program with check on incoming parts and final products. A final test procedure for product shall include a check of all performance specifications and a minimum 24 hour running.

XLVIII. INSTALLATION DRAWING

After the receipt of order a minimum two sets of installation drawings showing outline dimension, weights and connections and a one-line drawing of the UPS shall be sent to the purchaser to be used in planning the installation of the system.

XLIX. PRODUCT DOCUMENTATION

- i. Manufacturer shall supply a comprehensive set of product documentation for:
  - a. Installation
  - b. Operation
  - c. Maintenance
- ii. This should include complete outline and external connection drawings and schematic and physical wiring diagrams as well as parts list and parts layout down to the smallest components level. It should include startup and service manuals with complete privation and remedial maintenance and trouble showing instructions. This should include all ancillary equipment and accessories.

L. TRAINING

It is important that at least -2 personnel who are to be responsible for operation and maintenance of UPS be trained at the manufacturer site.

LI. SPARE PARTS

The recommended spare parts for 5 years of maintenance are to be listed and should be quoted along with main modules.

LII. MATERIAL AND WORKMANSHIP

- i. Workmanship shall be first class in every respect.
- ii. All material shall be new and of best commercial grade.

- iii. Brackets and securing hardware shall be electroplated with corrosion resistance material.
- iv. Internal wiring conductors shall be combined into cable or bundles and shall be tied securely together and numbered or coded to correspond with documentation.

LIII. STORAGE BATTERY

The storage battery shall be furnished with racks connecting hardware and standard service resistance material accessories. The battery shall be delivered charged and filled ready for service. The battery shall be maintenance free type VRLA, Lithium-ion, and NiCd.

LIV. SERVICE REPORT

Assigned field service report describing start-up and on-site testing shall be furnished.

LV. MAINTENANCE

If the battery is taken out of service for maintenance by manually opening battery disconnect switch the UPS shall continue to function and meet all the performance criteria specified except.

LVI. INVERTOR EFFICIENCY

96% minimum

LVII. PROTECTION CLASS

IP – 21

LVIII. PARALLEL – CONNECTION

Up to 4 module



## A. UBE BASED AUTOMATIC CLEAN AGENT FIRE SUPPRESSION FOR PANEL PROTECTION

### 1. General

- i. The scope covers Supply, Installation, Testing and Commissioning of Automatic Clean Agent FK 5-1-12 (Fluoroketone UL Listed) based Local Flooding System complete for electrical panels with flexible fire detection tubing, cylinder, valves, integration with Main Fire Alarm Control Panel for status monitoring etc. The scope of work includes, but not limited to the following,
  - a. Providing Direct Panel Gas Flooding System with flexible Linear Pneumatic Heat/fire detection/ discharge tubing inside the panels.
  - b. Clean agent storage cylinder for flooding gas inside the panels.
  - c. Any other item required to the successful commissioning of the system.
- ii. The electrical panel fire suppression system shall be complete with Seamless Aluminum Alloy Cylinders for required capacities, extinguishing agent as specified, fire detection tubing, filling and end-of-line adaptors, pressure switches, control equipment, Clean Agent Cylinder/Valve Assembly, Cylinder Mounting Bracket and all necessary accessories to protect the Electrical panel in case of fire. The system will have an interface with Main Fire Alarm and Control Panel. In case of fire in the concerned Panel, indication of Fire / discharge status should come in Main Fire Alarm and Control Panel.

### 2. Design Requirements

- i. All the detecting devices, alarm, indicating devices, containers and other related equipment shall have required approvals & Authorization.
- ii. All installations shall conform to NFPA 20001 requirements.
- iii. Clean Agent should be:
  - (a) The Clean Agent should have Zero Ozone Depletion Potential. (ODP = 0)
  - (b) The Clean Agent should not have Global Warming Potential of more than 1.
  - (c) The Clean Agent should be a low-pressure agent and atmospheric life time of 5days

### 3. System Equipment

#### **Linear Pneumatic Tube shall be UL Listed.**

The tubing shall be installed throughout the Electrical Panel with one end connected to the top of the Clean Agent container valve. The tubing shall be pressurized with Dry Nitrogen to 13.5 Bar and maintains the system in the "OFF" position. The tube shall burst at the hottest point at temperatures between 100-120-degree C. The tubing shall perform three functions:

- i. Heat Detection,
- ii. System Activation and
- iii. Clean Agent discharge.

#### **4. Pressure Switch**

Pressure Switch to Monitor Pressure Drop in the Tube, Switch Point 5 Bars.

#### **5. Clean Agent Storage Container (Seamless Aluminum Alloy)**

Cylinder shall be made of Aluminum Alloy and seamless, each storage container shall be equipped with a nickel-plated brass valve, a pressure gauge to monitor container pressure, and a quarter-turn ball valve that interfaces with the detection tubing. The quarter-turn ball valve shall be kept closed at all times when the container is not in service.

#### **6. Technical and Installation Requirements**

1. Provide sufficient amount of Extinguishing Agent to Inert the Micro environment being protected considering the following when computing volume to verify suitability and to establish design limitations:
2. Volume of hazard area.
3. Specific volume of Clean Agent.
4. Specifications for Electrical and Mechanical Works
5. Discharge time and flow rates.
6. Design concentration and design factors.
7. Detector/discharge tubing placement.
8. Placement of the cylinder
9. System should have provision to Interface system with main control fire alarm system and BMS.
10. All doors and holes in the enclosed/equipment should be closed or sealed to maintain the tightness of enclosure.
11. Each clean agent pre-engineered automatic system is equipped with its own detection/discharge tubing.
12. The unit shall be a self-contained and shall be equipped with its own non-electric automatic detection system to detect the fire and agent release system into the Electric panel to suppress the fire.
13. The Clean Agent is stored in Aluminum Alloy and Seamless Cylinders as compressed liquid, super-pressurized with Dry Nitrogen to 13.5 Bar. The ambient operating temperature range for all system components should be 0 Degree C to 54 degree C.
14. Each container is equipped with a nickel-plated brass valve, a pressure gauge to monitor container pressure, and a quarter-turn ball valve that interfaces with the Detection Tubing.
15. Provide wall-mounted painted steel bracket to mount the container/valve assembly in a vertical (upright) position. Each bracket should be equipped with integral quick-clamp straps.
16. Install equipment as indicated on the approved shop drawings, and in accordance with requirements of NFPA-2001.
17. Make final connections between equipment and system detection tubing under direct supervision of factory trained and certified representative of manufacturer.
18. It shall be so designed that it does not affect the IP ratings of electrical panels. The Sub-Contractor has to coordinate with manufacturer of electrical panels for provision

of holes to run the tube and brackets for mounting the tube. The entry of tube inside the panel shall be through suitable size of connector.

19. The tubing shall be manufactured from specially processed polymer material to achieve the desired heat detection and delivery characteristics.
20. The tubing shall be capable of working even when contaminated with oil, dust and debris as long as the contamination will allow the heat to pass through the tube.

## **7. CABLE WORK**

### DESCRIPTION OF WORK

Supply, laying, testing and commissioning of FRLS cables as per specifications, schedule of quantities and drawings.

### APPLICABLE CODES & STANDARDS

The 1.1KV Grade PVC insulated Cables, Installation of cables for low voltage system polyethylene insulated PVC sheathed cables, working voltages up to & including 1100 Volts, Method of test for cables, conductors for cables.

### SUBMITTALS

Cable schedule as per site conditions & good for construction drawings.

Layout of various cables on cable tray / trench along with sections showing no. of cables, distance between cables etc, size of cable trays etc.

Cable tray layout, as per site condition, duly coordinated with other services.

### TEST REPORTS

Routine test certificates for each drum of cable brought to site.

### specifications

#### **i. GENERAL**

Cable shall be supplied inspected, laid, tested and commissioned in accordance with drawings, specifications, relevant Japanese Standards Specifications and cable manufacturer's instructions. The cable shall be delivered at site in original drums with manufacturer's name clearly written on the drum.

#### **ii. MATERIAL**

The MV power cable of 1100 V. grade shall be XLPE insulated Copper conductor armoured cable.

The MV control cables shall be insulated copper conductor armoured cable.

## **8. INSTALLATION**

### **i. GENERAL**

The cable installation including necessary joints shall be carried out in accordance with the specifications given herein. For details not covered in these specifications. No straight through joint shall be permitted in the system. The cables shall be supplied as per cable schedule submitted by the contractor & approved by Engineer-in-Charge.

### **ii. PROXIMITY TO COMMUNICATION CABLES**

Power and communication cables shall as far as possible cross at right angles. Where power cables are laid in proximity to communication cables the horizontal and vertical clearances shall not normally be less than 30 cm.

### **iii. LAYING ON CABLE TRAY**

Cables, where indicated in approved shop drawings, shall be laid on overhead cable trays which are suspended from ceiling or supported from wall, by anchor fasteners as required.

The Contractor shall provide for all accessories for the installation of the cable trays, such as bends, tees, reducers coupler plates, and structural steel members (comprising of channels, angles, flats, rods) for structural supports for cable trays etc.

### **iv. CABLE TRAY MOUNTING**

Unless otherwise specifically noted on the relevant layout drawing, all cable tray mounting works to be carried out ensuring the following:

- a) Cable tray mounting arrangement type to be as marked on layout drawing.
- b) Assembly of tray mounting structure shall be supplied, fabricated, erected & painted by the contractor.
- c) Cable tray running along the wall should be supported at intervals not exceeding 1.5 m. In case of branching, there should be a support on all branches at a distance of 30 cm from the point of branching. Support should not be less than 40 mm x 40 mm x 5 mm GI angle-secured in an approved manner where runs are along the walls. In case of ceiling suspended cable tray horizontal supports made of 40 mm x 40 mm 5 mm GI angle iron shall be provided. The horizontal interval between two such supports shall be 1.0 meter. These supports shall be suspended from C.I. boxes or suitable approved suspension devices such as dash fastener of suitable sizes in the

ceiling by means of 10 mm diameter GI threaded rods. All above mounting accessories form part of installation of cable trays.

**v. TESTING & COMMISSIONING**

**a. INSPECTION**

All cables shall be inspected upon receipt at site and checked by the Engineer-in-Charge for any damage during transit.

**b. TESTING**

i. All 650/1100 Volt grade cables before laying shall be tested with a 500 V megger or with a 2,500/5,000 V megger for cables of higher voltages. The cable cores shall be tested for continuity, absence of cross phasing, insulation resistance to earth/sheath/amour and insulation resistance between conductors.

ii. All cables shall be subject to above mentioned tests during laying, before covering the cables by protective covers and back filling and also before the jointing operations.

**vi. COMPLETION PLAN AND COMPLETION CERTIFICATE**

a) After completion of the work the Contractor shall draw completion plans to a suitable scale and shall submit to the Engineer-in-Charge. The completion plans shall, inter-alia, give the following details

i) Layout of cable work

ii) Length, size, type and grade of cables.

iii) Method of laying i.e. direct in ground, in pipes etc.

iv) Location of each joint with jointing method followed.

v) Route marker and joint marker with respect to permanent land marks available at site.

vi) Wherever the previously laid cable is cut and additional joints are introduced etc., the cable records shall suitably be amended.

**vii. TESTING OF CABLES**

The cables shall be tested before and after laying. The Megger value in normal dry weather shall be 50 Mega ohm for 1.1 KV grade cable.

**viii. CABLE TAGS**

- i. Cable tags shall be made out of 2mm thick aluminium sheets. Each tag shall be 2" in dia or 3" x 3" square with one hole of 2.5mm dia, 6 mm below the periphery, or as approved by Consultant. Cable designations are to be punched with letters / number punches and the tags are to be tied to cables with piano wires of approve quality & size. Tags shall be tied inside the panels beyond the glanding as well as above the glands at cable entries. Along trays tags are to be tied at all bends. On straight lengths, tags shall be provided at every 5 meters.
- ii. Cables shall be secured to cable trays with 3mm thick x 25mm wide aluminium/copper strips/suitable GI clamp, or as approved by Consultant, at 1000 mm intervals and screwed by means of rust proof screws and washers, of adequate but not excessive lengths. Cable trays for horizontal runs suspended from the ceiling will be supported with mild steel straps or brackets, at 1000 mm intervals and the overall tray arrangement shall be of a rigid construction. External cabling route marker with C.I. plate marked with "DANGER 1.1 KV CABLE" with 0.6 meter long GI angle iron grouting bracket including 1:3:6 ratio cement concrete base block of minimum size 200 x 200 x 350 mm to be provided or as approved by Elect. Supply Company.

**9. RACEWAY**

All raceway shall be of 1.6mm / 2.0mm / 2.5mm thick Hot Dip Galvanized as specified in specifications. The raceway shall have Z- section, hole with thread for cover screw, coupler plate, cover, junction box, fly cover etc. as required. The screw for cover fixing shall be counter sunk type. The size of raceway shall be as follow.

<b>WIDTH (mm)</b>	<b>HEIGHT (mm)</b>	<b>THICKNESS (mm)</b>	<b>COVER THICKNESS (mm)</b>
50	40	1.6	2.0
75	40	1.6	2.0
100	40	1.6	2.0
150	40	1.6	2.0
200	40	1.6	2.0
300	40	2.0	2.0

## 10. DISTRIBUTION BOARDS

### A. GENERAL

a) Distribution Board shall be double door type with extended loose wire box & M.S. Junction Box at the top and suitable for flush installation. All distribution boards shall be of three phase (208 Volts) or single phase (120 Volts) type with incoming MCB and /or RCCB as in Bill of Quantities. Distribution boards shall contain plug in type miniature circuit breaker mounted on bus bars. Miniature circuit breakers shall be quick make & quick break type with trip free mechanism. MCB shall have thermal & magnetic short circuit protection. Bus bars shall be of electrolytic copper. Neutral bus bars shall be provided with the same number of terminals as there are single ways on the board, in addition to the terminals for incoming mains. An earth bar of similar size as the neutral bar shall also be provided. Separate neutral & earth bus bar link to be provided for each phase. Phase barrier shall be fitted and all live parts shall be screened from the front. Ample clearance shall be provided between all live metal and the earth case and adequate space for all incoming and outgoing cables. All distribution board enclosures shall have an etched zinc base stove painted followed by synthetic stove enamel, colour light gray. A circuit identification card in clear plastic cover shall be provided for each distribution board. IK (Mechanical Stress) rating of distribution board enclosure shall not be less than IK – 08 / 09.

b) Distribution Board with single phase outgoings requirement shall be Horizontal type. Distribution Board with three phase outgoings requirement shall be Vertical/ Horizontal type. Distribution Board installed in indoor dry locations shall conform to IP-42. Distribution Board installed in outdoor & wet locations shall conform to IP- 66.

c) Miniature Circuit Breakers for lighting circuits shall be of "C" series whereas the circuits feeding discharge lamps (HPMV or HPSV) halogen lamps, all power outlet points, equipment/ machinery shall be of "C/D" series (Motor circuit) types. All miniature circuit breakers shall be of not less than 10KA rated rupturing capacity. All miniature circuit breaker terminal shall have safety shutter.

d) Distribution board shall be provided with isolator or MCB and/or earth leakage circuit breaker as mentioned in drawings and specifications. Earth leakage circuit breaker shall be current operated type and of 100mA sensitivity unless otherwise stated. RCCB shall be mounted within distribution board box for single phase distribution board while in three phase distribution board RCCB shall be either mounted within distribution board box or in a separate MS box below distribution board. Width and depth of RCCB box shall be same as that of distribution board box and of same finish. Height of RCCB box shall be sufficient to accommodate RCCB & termination of incoming & outgoing wires. Distribution board box, isolator, MCB'S used shall be of one/same manufacturer. Standard size manufactured by approved manufacturer shall be used. In case size specified in specifications is not standard size of manufacturer, in that case next standard size distribution board box shall be used with incoming & outgoing MCB as specified in specifications. Additional cutout/space for

outgoing MCB shall be plugged with blank plates. No extra cost shall be paid for using bigger/higher size distribution board box and blank plates.

## B. CONDUIT AND WIRING SYSTEM

### i. GI CONDUIT

All conduit pipes shall be of approved gauge (not less than 16 SWG for conduits of sizes up to 32mm diameter and not less than 14 SWG for conduit of size above 32mm diameter) solid drawn or reamed by welding finished with stove enameled surface. All conduit accessories shall be of threaded type and under no circumstances pin grip type accessories shall be used. The maximum number of PVC insulated 650/1100 volts grade copper conductor cable that can be drawn in conduit of various sizes shall be as per code. No GI conduit less than 20mm in diameter shall be used unless otherwise stated.

### ii. CONDUIT JOINTS

Conduit pipes shall be joined by means of threaded couplers, and threaded accessories only. In long distance straight run of conduits, inspection type couplers at reasonable intervals shall be provided or running threads with couplers and jam nuts shall be provided. In the latter case the bare threaded portion shall be treated with anti-corrosive preservative. Threads on conduit pipes in all cases shall be between 13mm to 19mm long sufficient to accommodate pipes to full threaded portion of couplers or accessories. Cut ends of conduit pipe shall have no sharp edges nor any burrs left to avoid damage to the insulation of conductor while pulling them through such pipes.

Wherever conduit passes a building expansion joint, galvanized flexible metallic conduit shall be provided for connecting rigid GI Conduit in either slab.

### iii. PROTECTION AGAINST CONDENSATION

The layout of conduit should be such that any condensation or sweating inside the conduit is drained out. Suitable precaution should also be taken to prevent entry of insects inside the conduit.

### iv. PROTECTION OF CONDUIT AGAINST RUST

The outer surface of conduit including all bends, unions, tees, junction boxes etc forming part of conduit system shall be adequately protected against rust when such system is exposed to weather by being painted with two coats of oxide paint applied before they are fixed. In all cases, no bare threaded portion of conduit pipe shall be allowed. Unless such bare thread portion of conduit is treated with anticorrosive preservative or covered with approved plastic compound.



v. PAINING OF CONDUIT AND ACCESSORIES

After installation, all accessible surface of conduit pipes, fittings, switch and regulator boxes etc. shall be painted with two coats of approved enameled paint or aluminium paint as required to match the finish of surrounding wall, trusses etc.

vi. FIXING OF CONDUITS

**1. SURFACE CONDUIT**

- i. Conduit pipes shall be fixed by heavy gauge saddles, secured to suitable wood plugs or other approved plugs with screws in an approved manner at an interval of not more than one meter but on either side of the couplers or bends or similar fittings, saddles shall be fixed at a distance of 30cm from the centre of such fittings. The saddles should not be less than 24 gauge for conduits up to 25mm dia and not less than 20 gauge for larger diameter conduits. The corresponding widths shall be 19mm & 25mm. Where conduit pipes are to be laid along the trusses, steel joint etc. the same shall be secured by means of special clamps made of GI. Whereas it is not possible to drill holes in the trusses members suitable clamps with bolts and nuts shall be used. All fixing arrangement like saddles, special purpose clamps, nuts, bolts etc. shall deemed to be included in quoted rates of conduit.
- ii. For 25mm diameter conduit width of clip shall be 19mm and of 20 SWG. For conduit of 32mm and above, width of clip shall be 25mm and of 18 SWG.
- iii. Where conduit pipes are to be laid above false ceiling, either conduit pipes shall be clamp to false ceiling frame work or suspended with suitable supports from the soffit of slab. For conduit pipe run along with wall, the conduit pipe shall be clamped to wall above false ceiling in uniform pattern with special clamps if required to be approved by the Engineer-In-Charge at site.

**2. RECESS / CONCEALED CONDUIT**

- i. The chase in the wall shall be neatly made and of ample dimensions to permit the conduit to be fixed in the manner desired. In the case of building under construction, conduit shall be buried in the wall before plastering and shall be finished neatly after erection of conduit. In case of exposed brick/rubble masonry work, special care shall be taken to fix the conduit and accessories in position along with the building work. Entire work of chasing the wall, fixing the conduit in chases, and during the conduit in mortar before plastering shall form part of point wiring work. (For chase cutting-chase cutting machine shall be used and no manual cutting shall be allowed)
- ii. The conduit pipe shall be fixed by means of staples or by means of saddles not more than 60cm apart or by any other approved means of fixing. Fixing of standard bends and elbows shall be avoided as far as practicable and all curves maintained by bending the conduit pipe itself with the long radius which shall permit easy drawing in of conductors. All threaded joint of conduit pipe shall treat with some approved preservative compound to secure protection against rust. Suitable inspection boxes to the barest minimum requirements shall be provided to permit periodical

inspection and to facilitate replacement of wires, if necessary. These shall be mounted flush with the wall. Suitable ventilating holes shall be provided in the inspection box covers. Wherever the length of conduit run is more than 10 meters, then circular junction box shall be provided to facilitate pulling of wires. The chicken wire mesh shall be provided by civil agency.

**3. OUTLET BOXES:-**

Switch/outlet boxes shall be made of metal on all sides except on the front. Boxes shall be hot dip galvanized mild steel. Up to 20 x 30cm size M.S. Box shall have wall thickness of 16 SWG and MS boxes above 20x30cm size shall be of 14 SWG. The metallic boxes shall be painted with anticorrosive paint before erection. Clear depth of the box shall not be less than 60mm. all fitting shall be fitted in flush pattern. Switch/outlet boxes shall be suitable to house modular type light and power accessories. Earthing stud to be provided for connection of earthing wire in side of box at near any corner. Nakka shall be 3 mm thick.

**4. DEEP TEE: -**

The tee shall be made out of C.I. material. The dia of tee shall be 60 mm and the Depth of tee shall be 70 mm. The thickness of deep tee wall shall be 1.3mm to 1.5mm. (The sample to be approved before procurement/execution by owner / consultant.)

**5. ERECTION AND EARTHING OF CONDUITS: -**

The conduit of each circuit or section shall be completed before conductors are drawn in. The entire system of conduit after erection shall be tested for mechanical and electrical continuity throughout and permanently connected to earth conforming to the requirement by means of special approved type of earthing clamp effectively fastened to conduit pipe in a workman like manner for a perfect continuity between the earth and conduit. Gas, water pipe shall not be used as earth medium.

vii. LIGHT & POWER ACCESSORIES: -

**1. GENERAL**

All light & power accessories shall be of modular range of plate switch type and shall be of one manufacturer (brand) and type.

**2. LIGHT SWITCHES**

All switches for control of light shall be of 6/10 Amp unless otherwise stated. All switches shall be modular range of plate switch type. The switches shall be rocker mechanism type with silver contact. All switches shall be of white finish or as sample approved by owner/consultant.

**3. 6/16 AMP SWITCH SOCKET OUTLET.**

- i. Switch socket outlet on lighting circuit shall be of 3 pin 6Amp outlet shall have safety shutters. The switch shall be of rocker mechanism type with silver contact. Socket outlet shall be shutter type and of modular range of plate type and having white finish. Switch and socket outlet shall be mounted on a suitable size GI box with suitable size modular cover plate.
- ii. Switch socket outlet on power circuit shall be of 6 pin 16/6 Amp outlet (Universal Socket) shall have safety shutters. The switch shall be of rocker mechanism type with silver contacts. Socket outlet shall be shutter type and of modular range of plate type and having white finish. Switch and socket outlet shall be mounted on a suitable size G I box with suitable size modular cover plate.

**4. WIRING**

- i. All PVC insulated copper conductor multi-stranded wires shall conform to relevant codes. Cable conductor size and material shall be as specified in specifications.
- ii. All internal wiring shall be carried out with PVC insulated wires of 1100 volts grade. The circuit wiring for points shall be carried out in looping in system and no joint shall be allowed in the length of the conductors. Circuit wiring shall be laid in separate conduit originating from distribution board to switch board for light/fan. A light/fan switch board may have more than one circuit but shall have to be of same phase. Looping circuit wiring shall be drawn in same conduit as for point wiring. Each circuit shall have a separate neutral wire. Neutral looping shall be carried out from point to point or in light/fan switch boards. A separate earth wire shall be provided along with circuit wiring for each circuit. For point wiring red or yellow or blue colour wire shall be used for phase and black colour wire for neutral. Circuit wiring shall be carried out with red, yellow or blue colour PVC insulated wire for RYB phase wire respectively and black colour PVC insulated wire for the neutral wires. PVC insulated green colour wire shall be used as earth continuity conductor and shall be drawn along with other wires. No wire shall be drawn into any conduit until all work of any nature, that may cause injury to wire is completed. Care shall be taken in pulling the wires so that no damage occurs to the insulation of the wire.
- iii. Before the wires are drawn into the conduit, the conduits shall be thoroughly cleaned of moisture, dust and dirt.

**5. JOINTS**

All joints shall be made at main switches, distribution board socket and switch boxes only. No joint shall be made in conduits & junction boxes. Conductors shall be continuous from outlet to outlet.

## **6. SUB MAINS**

- i. Sub-main wiring shall be carried out with PVC Insulated Copper multi-stranded wires/cables in suitable GI. Conduit unless otherwise called for:
  - a. Sub-main cable where called for shall be of the rated capacity and approved make. Every sub-main shall be drawn into an independent adequate size conduit. Adequate size draw boxes shall be provided at convenient locations to facilitate easy drawings of the sub-main cables. Cost of junction box/drawn box is deemed to be included in the rates of sub-main wiring. An independent PVC insulated copper earth wire of proper rating shall be provided for every sub-main. Single phase sub-main shall have single earth wire whereas three phase sub-main shall be provided with two earth wire.
  - b. Where sub-mains cables are connected to the switchgear, sufficient extra lengths of sub-main and mains cable shall be provided to facilitate easy connections and maintenance. For termination of cables crimping type cable socket/lugs shall be provided. Same colour code as for circuit wiring shall be followed.

## **7. LOAD BALANCING**

Balancing of circuits in three phase installation shall be planned before the commencement of wiring and shall be strictly adhered to.

## **8. COLOUR CODE FOR CIRCUIT & SUB-MAIN WIRING**

Colour code for circuit & sub-main wiring installation shall be Red, Yellow, Blue for three phases. Black for neutral and green for earth in case of insulated earth wire.

### viii. CLASSIFICATION OF POINTS: -

#### **1. General**

- i. Classification and measurement of Point wiring shall be as follows:
- ii. Conduiting & wiring from switch to first point including circuit wiring along with conduits, shall be classified as "One point (First point) controlled by one number 6Amp one way/two-way switch".
- iii. Conduiting & wiring from first point to next point to be controlled by same switch in same circuit shall be classified as "Looping Points".

#### **2. CONDUCTOR SIZE**

- i. Wiring shall be carried out with following sizes of PVC insulated multi-stranded single core copper conductor wire/cable.
 

a. Light point	-	1.5 Sq.mm
b. Ceiling/Cabin/Exhaust Fan Point	-	1.5 Sq.mm
c. Light Circuit Wiring	-	1.5 Sq.mm
d. Plug Point (5 A outlet)	-	2.5 Sq.mm

- e. 6A Circuit Wiring - 2.5 Sq.mm
- f. MCB Control Light Point - 2.5 Sq.mm
- g. General Power Point (15A S.S. outlet)-Second Point - 4.0 Sq.mm
- h. Power Point for Hand dryer / A.C. Unit - 4.0 Sq.mm
- ii. Maximum number of PVC insulated 650/1100 V grade copper conductor cable, that can be drawn into rigid GI conduit.

Nominal Cross-sectional Area of conductor in Sq. mm	20mm		25mm		32mm		38mm		51mm		64mm	
	S	B	S	B	S	B	S	B	S	B	S	B
1	2	3	4	5	6	7	8	9	10	11	12	13
1.50	5	4	10	8	18	12	-	-	-	-	-	-
2.50	5	3	8	6	12	10	-	-	-	-	-	-
4	3	2	6	5	10	8	-	-	-	-	-	-
6	2	-	5	4	8	7	-	-	-	-	-	-
10	2	-	4	3	6	5	8	6	-	-	-	-
16	-	-	2	2	3	3	6	5	10	7	12	8
25	-	-	-	-	3	2	5	3	8	6	9	7
35	-	-	-	-	-	-	3	2	6	5	8	6
50	-	-	-	-	-	-	-	-	5	3	6	5
70	-	-	-	-	-	-	-	-	4	3	5	4

**NOTE:**

The above table shows the maximum capacity of conduits for a simultaneous drawing in of cables.

The columns headed 'S' apply to runs of conduits which have distance not exceeding 4.25m between draw in boxes and which do not deflect from the straight by an angle of more than 15 degrees. The columns headed 'B' apply to runs of conduit which deflect from the straight by an angle of more than 15 degrees.

Conduit sizes are the nominal external diameters.

ix. CONDUITING AND WIRING FOR SAMTV SYSTEM:-

**1. CONDUITING**

Conduiting for SMATV system shall be carried out in GI. Conduit. Conduiting shall be carried out as per Clause No. 3.7.2 of this specification.

**2. OUTLETS**

All SMATV outlets shall be provided with modular range of cover plate, box and coaxial outlet. Cover plate shall match in shape & finish with other light and power accessories.

**3. JUNCTION BOX**

Suitable size of metallic junction box shall be provided for termination of conduit for SAMTV system. Box shall be made of 1.6mm thick MS sheet and shall be treated before painting. Front of the junction box shall be provided with 3mm thick phenolic laminated sheet cover.

**4. CATV LINE AMPLIFIERS**

The CATV Amplifier shall be housed in a high frequency resistant Aluminium housing. The CATV Amplifier shall have an in-built variable equalizer and Alternator for site signal condition adjustments.

**5. COAXIAL CABLES**

The coaxial cable shall be of wideband type (RG-11 for Riser & RG-6 for distribution)

**6. TAP OFF**

- i. These shall be of ultra-wide bandwidth and of hybrid type. These shall have a flat frequency response over the entire operating range. These shall have an aluminium cast housing for high frequency radiation resistance.
- ii. The Tap offs shall be in one way, two way and four-way configurations.

**7. SPLITTERS**

- i. These shall be of ultra-wide band width and of hybrid type. These shall have a flat frequency response over the entire operating range. These shall have a aluminium cast housing for high frequency radiation resistance.
- ii. The splitters shall be in 2-way, 3 way & 4 way configurations

x. NETWORKING SYSTEM

1. **GENERAL**

The OEM should be a member of TIA/EIA (Proof must be available on public platform) It is mandatory to have at least 1 RCDD certified person in OEM. The entire passive components Copper & Fiber should be from single OEM of one make. Quoted product part numbers must be available on OEM's official website The OEM should not be blacklisted by the Central/State Government, the subordinate organizations, public sector undertakings of government or a statutory authority from participating in any project as on the date of proposal

i. **Cat 6A U/FTP Shielded Cable**

- a. Category 6A 4 pair U/FTP shielded LSZH cable should be compliant with TIA/EIA-568-C.2
- b. Should be of 4 twisted pairs of 23 AWG solid conductors
- c. Should support network line speed up to 10 Gigabits pr second.
- d. Shall be 4-pair Unshielded twisted pair with a cross filler/ isolator (+), meeting Category 6A tested to 500 MHz or more (4 connector test report from ETL(Intertek) to be submitted with offer).
- e. Should be ETL verified to TIA/EIA-568-C.2 Catgory 6A standard for 500MHz (ETL certificate to be enclosed along with the bid)
- f. Must comply with IEC 61156-5, IEEE 802.3bt
- g. Third party report of Full Cat6A Channel/Performance Test should be enclosed along with the technical bid.

ii. **Mechanical Characteristics**

- a. Construction: 4 pair shielded cable should be constructed of 4 individual screened pairs.
- b. Conductor should be solid Copper
- c. Conductor Size should be 23 AWG
- d. Insulator should be Polyethylene/Polyolefin
- e. Jacket/ Sheath type should be LSOH (Low Smoke Zero Halogen) as per IEC 60332-1/ IEC 60332-3
- f. NVP should be 75-77% or better

- g. Screen should be each individual pair enclosed in laminated aluminium foil with drain wire.
- h. Propagation Delay Skew should be 45 nS/100 max @ 1-500 MHz
- i. Mean Impedance should be  $100\Omega \pm 6$  @ 1-500 MHz
- j. Coupling Attenuation should be 45dB min @30-100 MHz 40-20 Log (f/100) @ 100-500 MHz
- k. Operating Temperature should be Installation: 0°C to +50°C and Operation: -20°C to +60°C
- l. Should be RoHS Compliant
- m. Should be certified by ETL/UL

**iii. CAT6 A 24 PORT Shielded JACK-k PANEL LOADED: -**

- a. Should be supplied with individually replaceable 24 numbers Category-6A I/O shielded Jacks complying as per the ANSI/TIA-568C.2
- b. Should be 19" rack mountable and of 1U height & complete with all mounting accessories
- c. Should have label holder/cover for identification of ports
- d. IDC Connector plastic housing should be polycarbonate and UL94V-0 rated.
- e. Operating Life should be Minimum 20 reterminations and contact material should be copper alloy.
- f. Material should be CRS (cold rolled steel)
- g. Should be supplied with metallic integrated rear cable management shelf as for cable strain relief.
- h. Should have provision for better cable dressing at the rear
- i. I/O operating Life should be minimum 750 insertion cycles and contact material should be copper alloy.
- j. I/O contact plating should be 50µ Gold/ 50µ Nickel minimum



- k. I/O should be Spring-loaded shutter to protects from dust and contaminants.
- l. Should be RoHS Compliant
- m. Should be certified by ETL/UL

**iv. CAT6 A SHIELDED TWISTED PAIR PATCH CORDS (1/2/3/5 Mtr)**

- a. Category 6A Equipment cords (Length – 1/2/3/5 Mtr)
- b. Conductors Should be of 4 twisted pairs of 26 AWG stranded copper for better flexibility
- c. Patch cords should conform to ANSI/TIA-568-C.2 for Cat 6A
- d. Should have RJ-45 jacks with boot at both the ends.
- e. All patch cords should be factory crimped and packed.
- f. Should have LSZH jacket for safety
- g. Operating Temperature should be -25°C to +55°C
- h. Screen material should be aluminum/polyester shield with tinned copper drain wire.
- i. Plug Insertion Life should be Minimum 750 times
- j. Contact Plating should be 1.27um gold or better
- k. Shall be RoHS Compliant
- l. Should be certified by ETL/UL.

**v. FACEPLATE (Single Port)**

- a. Single square plate, 86SMx86SM,
- b. Write on labels in transparent plastic window – supplied with plate
- c. Screw hole covers – to be supplied with plate, Plug in Icons – Icon tree – to be supplied with plate
- d. Should be able to support variety of jacks – UTP, FTP

**vi. Cat6A INFORMATION OUTLET (JACK)**

- i. Should be conform to Category-6A as per ANSI/TIA-568-C.2
- ii. Should be support network line speeds up to 10 Gbps
- iii. I/O operating Life should be minimum 750 insertion cycles and contact material should be copper alloy.
- iv. I/O contact plating should be 50 $\mu$  Gold/ 50 $\mu$  Nickel minimum
- v. I/O should be Spring-loaded shutter or cap to protects from dust and contaminants.
- vi. All information outlets for 22-24 AWG copper cable should be use insulation displacement connectors (IDC)
- vii. Operating Life should be minimum 750 insertion cycles
- viii. Operating Life should Minimum 20 re-terminations.
- ix. Wire Accommodation: 22-24 AWG solid
- x. Plastic Housing must be Polycarbonate, UL94V-0 rated
- xi. I/O should be terminated using industry standard punch-down tools.
- xii. Should be RoHS Compliant
- xiii. Should be certified by ETL/UL

**vii. Cat-6A Shielded Connectors/ RJ45 Plug (Toll Less )**

- i. Should be conform to Category 6A
- ii. RJ-45 meets TIA-568.2-D Category 6A component performance.
- iii. IP 20 rated
- iv. Plug Insertion Life should be Minimum 750 times
- v. Should support for 23-26 AWG wire size
- vi. Should Supports 10GB networks
- vii. Contact plating material should have 50u" gold plating

- viii. Shall be RoHS Compliant
- x. Should be certified by ETL/UL.

**Single Mode fiber 6/12 core: -Armored Uni-Tube, 9/125µm, OS 2 Type Optical Fiber Cable**

<b>Cable Type</b>	Optical fibers in water blocked loose tube, taped, corrugated steel tape armored (STA) polyethylene (HDPE) outer sheathed embedded with two steel wires on th periphery. The cables are ith UV Stabilized PE Jacket and protected from Rodent attacks. Complying to ISO/IEC 11801, EN50173, ANSI/TIA 568-C.3, Telcordia GR-20; suitable for use in indoor / outdoor ducts, direct burial and backbone cabling.
<b>Fiber Type</b>	Single Mode, 9/125-micron primary coated buffers, OS2 (IEC 60793-2-50, B1.3 and ITU T G652.d).
<b>Construction type</b>	Uni-tube construction,
<b>Tube:</b>	Polybutylene, Terephthalate (PBT)
<b>Tube color:</b>	White
<b>Tube diameter</b>	3.0/2.0 mm nominal OD/ID
<b>No of fibers:</b>	4/6/8/12
<b>Fiber color sequence</b>	Blue, Orange, Green, Brown, Slate (Grey), White, Red, Black, Yellow, Violet, Pink, Aqua
<b>Water Blocking</b>	Thixotropic Gel (Tube) Petroleum Jelly (Interstices)
<b>Core Wrapping</b>	Polyethylene Terephthalate
<b>Armoring:</b>	Corrugated Steel Tape Armor (ECCS Tape) Thickness > 0.125mm
<b>Peripheral Strength Member</b>	Two Steel wires (0.9 mm dia)
<b>Ripcord:</b>	Polyester based yarns below armored tape for easy ripping
<b>Outer Sheath</b>	UV Stabilized Polyethylene (HDPE)

<b>Sheath thickness</b>	2.0 mm nominal
<b>Sheath color</b>	Black
<b>Standards</b>	ISO/IEC 11801 2nd Edition, type OS1/OS2; AS/ACIF S008; AS/NZS 3080; TIA/EIA 568.C.3; IEC-60793-1, 60793-2 EN50173, ANSI/TIA 568-C.3, Telcordia GR-20; suitable for use in indoor / outdoor ducts, direct burial and backbone cabling, RoHS Compliant
<b>Mechanical characteristics</b>	Required Value
<b>Dimensions and Mass Overall, Cable (Nominal):</b>	9.0 MM
<b>Mass (Nominal)</b>	80 kg/km +- 1o %
<b>Cable length</b>	2 km ± 10%
<b>Max. Bending Radius (During installation)</b>	20 X Overall diameters
<b>Max. Bending Radius (During full load):</b>	10 X Overall diameters
<b>Max. Tensile Strength-Short Term</b>	1500N
<b>Max. Crush Resistance-Short Term:</b>	2000N/10 cm
<b>Operating Temperature range</b>	. -20°C ±70°C

**Electrical/Optical Characteristics**

**Attenuation** Characteristics-Optical Performance Max. Attenuation (Cable with fibers) At 1310 nm: 0.35 dB/km at 1550 nm: 0.22 dB/km Max. Average Attenuation; At 1310 nm: 0.33 dB/km at 1550 nm: 0.21 dB/km

**Single Mode fiber 24/48/72 core: -Armored Multi-Tube, 9/125µm, OS 2 Type Optical Fiber Cable.**

Should be ISO/IEC 11801:2002; Multi-tube Armoured with ECCS tape

Type: Single Mode. 9/125 micron, OS2

Cable Jacket material: 1.8 mm HDPE sheath

Minimum Cores 24

Cable overall diameter 10.8 mm or more

Tensile Strength 3500N short term and crush resistance 4400N

Central Strength Member: Fibre Reinforced Plastic (FRP)

<b>Mechanical characteristics</b>	<b>Required Value</b>
<b>Core Diameter</b>	9.2 ± 0.4 µm
<b>Cladding Diameter</b>	125 ± 1.0 µm
<b>Coating Diameter</b>	242 + 5 µm
<b>Primary Coating Cladding Concentricity error</b>	≤ 12.0 µm
<b>Max. Attenuation</b>	At 1310 nm: 0.35 dB/km At 1550 nm: 0.22 dB/km
<b>Chromatic Dispersion</b>	1285-1330 nm: ≤3.5 ps/nm.km 1550 nm: ≤18.0 ps/nm.km
<b>Zero Dispersion Wavelength</b>	1302 to 1322nm

**Zero Dispersion Slope**  $\leq 0.091 \text{ ps/nm}^2 \cdot \text{km}$

**Cable cut-off wavelength**  $\leq 1260 \text{ nm}$

**Mode Field Diameter at 1310nm**  $9.2 \pm 0.5 \mu\text{m}$

**Core clad Concentricity Error**  $\leq 0.8 \mu\text{m}$

**Cladding Non-Circularity**  $\leq 1 \%$

**Polarization mode dispersion**  $\leq 0.2 \text{ ps/km}$

End to End Structured Cabling Products from Single Brand and Single OEM

**Warranty** 25 years of System Performance and application Assurance warranty  
Site certificate must be issued by OEM.

**MAF** Bidder Must produce the manufacturer Authorization certificate from the OEM

**LC-LC Type 9/125 $\mu\text{m}$  Single mode OS2 Optical Fiber Patch Cords: -**

9/125  $\mu\text{m}$ , OS2, Duplex Zip cord.

**Connectors** The optical fiber patch leads shall comprise of Single-mode 9/125 $\mu\text{m}$  OS2 fiber with 2XLC type fiber connectors terminated at one end and 2X LC type fiber connectors at another end of the patch cord.

**Cordage O. D** (Duplex):  $2.0\text{mm} \pm 0.1\text{mm} \times 4.1 \pm 0.2\text{mm}$

**Buffer Diameter** 900 $\mu$  tight buffer

**Strength Member** Aramid Yarn

**Jacket Material** LS0H IEC 61034-1 & 2, IEC-60332-1, IEC-60754-1 & 2

Connector Loss 0.30dB(max)

Operating Temperature -40°C to +85°C

**Certificate** ETL Tested

**Standards** ISO/IEC 1108:2008, ANSI/TIA/ EIA 568.C.3, ANSI/TIA/EIA-492, TELECORDIA GR-409, ICEA-596

**6 /12/24**

**Port Fiber Optic Rack Mount LIU with Adaptors Plates, Splice Tray and Pigtails: -**

**Connector Type** LC-Style

**Operating temperature** -20 Degree C to +70 Degree C or better

**MM connectors** 500 cycles, Beige

**SM connectors** 200 cycles, Blue

**Ferrules** Pre-radiused Ceramic Ferrules

**Attenuation** Not more than 0.75 dB per mated pair

**Fiber Optic Patch panels** 6/12/24 Ports Loaded

**FMS- Front Patching / Splicing Shelf** 1U 19" / ETSI versions available

The FMS fiber management shelf series is ideal for high density front patching applications.

Its compact design and high-density capacity allow it to deliver carrier class fiber management to central offices, Pops, FTTx, mobile systems and LANs.

**High Density** 1U: 12/24 Fiber terminations Upgradable Upto 96 LC port in 1 U

Should be supplied loaded with secondary coated LC pigtails, Splice Tray & Splice Protector

Mounting brackets can be placed in different positions

**Sliding Drawer concept allows for**

Easy access to splicing tray

Easy access to back side of connector

Labeling strip for adhesive labels and better cable management

Fiber guides, radius controls & secure tie downs provided

**Multi-Mode fiber 6/12 core: -Armored Uni-Tube, 50/125µm, OM4 Type Optical Fiber Cable**

**Cable Type**

Optical fibers in water blocked loose tube, taped, corrugated steel tape armored (STA) polyethylene (HDPE) outer sheathed embedded with two steel wires on the periphery. The cables are with UV Stabilized PE Jacket and protected from Rodent attacks. Complying to ISO/IEC 11801, EN50173, ANSI/TIA 568-C.3, Telcordia GR-20; suitable for use in indoor / outdoor ducts, direct burial and backbone cabling.

**Fiber Type**

Multi-Mode, 50/125-micron primary coated buffers, OM4 (IEC 60793-2-50)

**Construction type**

Uni-tube construction,

**Tube:**

Polybutylene, Terephthalate (PBT)

**Tube color:**

White

**Tube diameter**

3.0/2.0 mm nominal OD/ID

**No of fibers:**

4/6/8/12

**Fiber color sequence**

Blue, Orange, Green, Brown, Slate (Grey), White, Red, Black, Yellow, Violet, Pink, Aqua

**Water Blocking**

Thixotropic Gel (Tube) Petroleum Jelly (Interstices)



<b>Core Wrapping</b>	Polyethylene Terephthalate
<b>Armoring:</b>	Corrugated Steel Tape Armor (ECCS Tape) Thickness > 0.125mm
<b>Peripheral Strength Member</b>	Two Steel wires (0.9 mm dia)
<b>Ripcord:</b>	Polyester based yarns below armored tape for easy ripping
<b>Outer Sheath</b>	UV Stabilised Polyethylene (HDPE)
<b>Sheath thickness</b>	2.0 mm nominal
<b>Sheath color</b>	Black
<b>Standards</b>	ISO/IEC 11801 2nd Edition; OM4 AS/ACIF S008; AS/NZS 3080; TIA/EIA 568.C.3; IEC-60793-1, 60793-2 EN50173, ANSI/TIA 568-C.3, Telcordia GR-20; suitable for use in indoor / outdoor ducts, direct burial and backbone cabling, RoHS Complaint
<b>Mechanical characteristics</b>	Required Value
<b>Dimensions and Mass Overall, Cable (Nominal):</b>	9.0 MM
<b>Mass (Nominal)</b>	80 kg/km +- 10 %
<b>Cable length</b>	2 km ± 10%
<b>Max. Bending Radius (During installation)</b>	20 X Overall diameters
<b>Max. Bending Radius (During full load):</b>	10 X Overall diameters

**Max. Tensile Strength-Short Term** 1500N

**Max. Crush Resistance-Short Term:** 2000N/10 cm

**Operating Temperature range** . -20°C ±70°C

**Electrical/Optical Characteristics**

**Attenuation** Characteristics-Optical Performance Max. Attenuation (Cable with fibers) At 1310 nm: 0.35 dB/km at 1550 nm: 0.22 dB/km Max. Average Attenuation; At 1310 nm: 0.33 dB/km At 1550 nm: 0.21 dB/km

**LC-**

**C Type 50/125µm Multimode OM4 Optical Fiber Patch Cords: -**

50/125 µm, OM4, Duplex Zipcord.

**Connectors** The optical fiber patch leads shall comprise of Multimode 50/125µm OM4 fiber with 2XLC type fiber connectors terminated at one end and 2X LC type fiber connectors at another end of the patch cord.

**Cordage O. D** (Duplex): 2.0mm ± 0.1mm x 4.1± 0.2mm

**Buffer Diameter** 900µ tight buffer

**Strength Member** Aramid Yarn

**Jacket Material** LSOH IEC 61034-1 & 2, IEC-60332-1, IEC-60754-1 & 2

**Connector Loss** 0.30dB(max)

**Operating Temperature** -40°C to +85°C

<b>Certificate</b>	ETL Tested
<b>Standards</b>	ISO/IEC 1108:2008, ANSI/TIA/ EIA 568.C.3, ANSI/TIA/EIA-492, TELECORDIA GR-409, ICEA-596

**6 /12/24**

**Port Fiber Optic Rack Mount LIU with Adaptors Plates, Splice Tray and Pigtails: -**

<b>Connector Type</b>	LC-Style
<b>Operating temperature</b>	-20 Degree C to +70 Degree C or better

<b>MM connectors</b>	500 cycles, Beige
----------------------	-------------------

<b>SM connectors</b>	200 cycles, Blue
----------------------	------------------

<b>Ferrules</b>	Pre-radiused Ceramic Ferrules
-----------------	-------------------------------

<b>Attenuation</b>	Not more than 0.75 dB per mated pair
--------------------	--------------------------------------

<b>Fiber Optic Patch panels</b>	6/12/24 Ports Loaded
---------------------------------	----------------------

<b>FMS- Front Patching / Splicing Shelf</b>	1U 19" / ETSI versions available
---	----------------------------------

The FMS fiber management shelf series is ideal for high density front patching applications.

Its compact design and high-density capacity allow it to deliver carrier class fiber management to central offices, Pops, FTTx, mobile systems and LANs.

<b>High Density</b>	1U: 12/24 Fiber terminations Upgradable Upto 96 LC port in 1 U
	Should be supplied loaded with secondary coated LC pigtails, Splice Tray & Splice Protector
	Mounting brackets can be placed in different positions
	Easy access to splicing tray

<b>Sliding Drawer concept allows for</b>	Easy access to back side of connector
	Labeling strip for adhesive labels and better cable management
	Fiber guides, radius controls & secure tie downs provided

**24 PORT POE**

<b>Parameters</b>	<b>Minimum specification</b>
Port Density	48 X 1G RJ-45 PoE+ Ports with 760W power budget. It should support Multigig on minimum 2 Ports out of 48 Ports. 2 x 1G/10G SFP+ Ports and 2 x 1G SFP/Base-T Combo Ports upgradable to 2 x 10G SFP+ Ports.
Power Supply	Internal Power Supply
Virtual Chassis/ Stacking Option	Upto 4 Switches or more
RAM	1 GB or better
Flash	1 GB or better
Switching Capacity and forwarding Rate	182 Gbps or better and 135 Mpps or better
Latency & MTBF	Latency: < 4 μs MTBF: 789 k hours
Layer 2 Features	Mac Address:16K or more VLAN: 4K or more System Policies: 1.5K or more Max Jumbo Frame: 9216 bytes Multicast Group: up to 1000
Quality of Service	Auto QoS for switch management traffic, Policy-based QoS, Traffic Prioritization, Priority Queues: Eight hardware-based queues per port, SPQ, WRR

Protocol Support	Static Routing, MSTP, RSTP, PVST+,IPv6 Tunneling, LACP, LAG, IGMPv3, DHCP, DHCP82,DHCP Relay for IPv4/IPv6,Multiple microcode image support with fallback recovery, ARP,SDN support through Restful API and OpenFlow 1.3.1
Management	Loopback IP address support for management per service, Policy- and port-based mirroring, Remote port mirroring, sFlow v5 and Remote Monitoring (RMON), Unidirectional Link Detection (UDLD), Digital Diagnostic Monitoring (DDM), LLDP-MED, NTP, MVRP, SNMP, sflow or equivalent
Security	Dynamic change of authentication (CoA), MAC-based authentication for non-IEEE 802.1X hosts, MAC address lockdown, Prevention from ARP attacks, Web based Authentication, Autosensing IEEE 802.1X multi-client, multi-VLAN support, RFC 1321 MD5, RFC 2284 PPP EAP,RFC 1826/1827/4303/4305 Encapsulating Payload (ESP) and crypto algorithms, RFC 2104 HMAC Message Authentication, Built-in CPU protection against malicious attacks
Resiliency	Unified management, control and virtual chassis technology, Virtual Chassis 1+N redundant supervisor manager, Virtual Chassis In-Service Software Upgrade (ISSU), Smart continuous switching technology, IEEE 802.3ad/802.1AX Link Aggregation Control Protocol (LACP) and static LAG groups across modules
Operating Temperature and Humidity	Temperature: 0 to 45Deg Humidity: 5% to 95% (non-condensing)
Safety Certifications	CE, EN 55022, RoHS, WEEE  US UL 60950, CSA22.2  FIPS 140-2  EN 60825-1/2 Laser, IEC 62368-1
SFP	SFP should be of same make as switch.

Vendor to be present in Gartner Magic Quadrant.

The Switch shall work with on-premise and cloud-based NMS without change in hardware/software/OS Image.

xi. INDOOR WIRELESS ACCESS POINT

- i. Proposed solution will be Controller less/HW Controller based/SW Controller based but all the Access Points managed centralized.
- ii. The WLAN solution shall propose an Indoor 802.11ax Wifi 6 MU-MIMO indoor dual radio AP Access Point (2.4, 5G)
- iii. AP to support 4X4:4 on 5 Ghz and 2X2:2 on 2.4 Ghz.
- iv. Access Point shall offer up to 2400 Mbps throughput on the 5Ghz band (low and high bands) and up to 573 Mbps throughput on the 2.4GHz band.
- v. 1 x 10/100/1000Base-T autosensing (RJ-45) port and 1x 10BASE-Te/100BASE-TX/1000BASE-T/2500BASE-T IEEE 802.3 compliant autosensing (RJ-45) port. Both ports should support 802.3at PoE, 1x USB 2.0 Type C
- vi. AP should support ACL, wIPS/wIDS and DPI application, 802.11i, 802.1x
- vii. Access Point shall propose a Factory reset button.
- viii. Access Point shall support up to 32 SSIDs (16 per radio) with 1024 Clients and should support BLE 5.1/Zigbee Integrated. Single AP can act in dual mode (WLC/Client Serving) with controller to support 256 Access Points in single cluster.
- ix. Distributed Radio Management, Radio Dynamic Adjustment (RDA), Transmit Power Control @ 18 dBm (TPC), DFS, VHT20,40,80,160
- x. L2 Roaming
- xi. 802.11r Roaming, 802.11K, 802.11v
- xii. Operating temperature must be 0°C to 50°C
- xiii. Humidity must be 10% to 90% non-condensing.
- xiv. WFA, UL2043 Plenum rating, EMI, RoHS, REACH, WEEE
- xv. FCC and CE approval and certificates,

xvi. The AP shall work with on-premise and cloud based WLC without change in hardware/software/OS Image

xii. DISTRIBUTION SWITCH

<b>Parameters</b>	<b>Minimum specification</b>
Port Density	26 X 1/10G SFP Ports 2 x 40/100 G QSFP28 Ports
Power Supply	Redundant Hot Swappable Power Supply - AC/DC
Virtual Chassis/ Stacking Option	Upto 6 Switches or more
RAM	8 GB or better
Flash and Buffer	32GB or better and 32MB Packet Buffer
Switching Capacity and forwarding Rate	900 Gbps or better and 650 Mpps or better
Latency & MTBF	Latency: <650 ns MTBF: 384,636 h
MAC Address	64K
Routes	IPv4 - 32k or better IPv6 - 16k or better
Quality of Service	Support for Egress rate limiting, Eight egress queues per port, IEEE 802.1Q, 802.3x, DiffServ, Jumbo frame
Protocol Support	IGMP Snooping V1, V2, V3, MLD, PIM-SM/PIM-SSM/PIM-DM/PIM-Bidirectional, DVMRP, IPv1 & v2, RIPv1, OSPFv3, RIP, BGPv4, MP-BGP, GRE, IS-IS, ITU-T G.8032, IEEE 802.1s, IEEE 802.3ad/802.1AX Link Aggregation Control Protocol (LACP), Ipv4/Ipv6, DHCP Option 82, BPDU, STP Root Guard, SIP detection, SPB-M or MPLS, IEEE 802.1ae, MIB, NTP, Built-in CPU protection against malicious attacks, The Switch Should have 1+N redundant supervisor manager in Virtual

	chassis with In-Service Software Upgrade (ISSU), VXLAN, ARP Poisoning detection, Policy based routing (PBR),SDN support through Restful API and openflow 1.3.1
Management	SNMP V1,V2,V3, Web GUI, CLI, USB or equivalent memory card, IPv6 management feature on open standards, IEEE802.1ag, TDM or equivalent standards
Security	Should support Access Control Lists (ACLs), DHCP snooping, IEEE802.1x based port authentication, RADIUS/ TACACS+, SSL, SSH, port mirroring, NTP, IEEE 1588, AES, Syslog, MD5, LLDP-MED, BPDU Blocking, BFD, Unified management, control and fabric-mesh virtual chassis technology, Autosensing IEEE 802.1X multi- client, multi-VLAN support for bridging and SPBM/VXLAN services, MAC-based authentication for non-IEEE 802.1X hosts, MAC address lockdown, Prevention from ARP attacks
Resiliency	IEEE802.1q, IEEE802.1d, IEEE802.1s, IEEE802.1w, ITU-T G.8032 ring resilience/ring protection, VRRPv2,
Operating Temperature and Humidity	Temperature: 0 to 45Deg Humidity: 5% to 95% (non-condensing)
Safety	CE, EN 55022, RoHS
Certifications	US UL 60950, CSA22.2 FIPS 140-2, EAL2 & NCPP Certified EN 60825-1/2 Laser
SFP	SFP should be of same make as switch.  Vendor to be present in Gartner Magic Quadrant.  The Switch shall work with on-premise and cloud based NMS without change in hardware/software/OS Image. The Switch should be EAL2/NDPP certified



## B. ADDRESSABLE FIRE ALARM SYSTEM

### a. GENERAL FIRE ALARM SYSTEM DESCRIPTION

- i. Fire detection and Alarm System shall consist of Fire Alarm Control Panels, various types of equipment's like Detectors, hooters, Strobes, monitor & control modules, Repeater panel, and different types of cables located at various strategic locations of the building.
- ii. In case of a Fire alarm initiation by an alarm-initiating device, the audio-visual fire alarm shall be generated at the respective Fire Alarm Control Panels and at Repeater panel located in the Control Room, various location and initiate signal to operate hooters located in various locations.
- iii. All the alarm-initiating devices that are asked for to be self-addressable type shall be of self-addressable type. In case of non-addressable detectors, the detector status shall be monitored through a Conventional Zone Interface Module (CZIM) to send the analogue information available from the detector to FACP. The BIDDER shall clearly indicate what are all the device / detectors which are not self-addressable in type and shall include CZIM module to make that device / detector addressable. The CZIM module cost shall also be considered as included in the detector cost
- iv. The detector shall be suitable to connect to the control unit via a four-wire circuit (Class –A wiring) as per NFPA.
- v. The Fire Alarm System envisaged for this Building is "2-Wire Analog Addressable" type.
- vi. The communication between detectors and the FACP is by means of digital communication over 2-wire, which further provides power to the detectors, devices & Sounders. There shall be A/D and D/A conversion happening inside the detectors and FACP.
- vii. All the detectors shall be incorporated with microprocessors and shall be provided with Analog to Digital Converter (ADC), which enables the detector to provide linear output corresponding to the quantity of smoke or fire, the detector encounter.
- viii. All types of detectors offered will be of restorable type i.e. suitable for operating afresh after each actuation on alarm without replacement or adjustment.
- ix. The sensitivity of each sensor shall be individually adjusted from the FACP to suit the conditions of each location. Each detector shall have self-test facility, which is monitored in the FACP. Each detector shall have drift compensation.
- x. The FACP shall also check each sensor for contamination of dust/dirt and give signal for "Service" in case of accumulation of dust/dirt reaches a preset limit.
- xi. The fire alarm system shall work without any problem both in networked mode and in standalone mode.
- xii. The electronic circuit shall be of solid state and of failsafe design and virtually hermetically sealed to have resistance to humidity and corrosion and to prevent its

- operation from being impaired by dust and dirt.
- xiii. The circuit shall be protected against usual electrical transients, electromagnetic and electrostatic interference (EMI & RFI) present in the Building.
  - xiv. Reverse polarity or fault in the field wiring shall not damage the detector.
  - xv. No moving parts subject to wear & tear shall be provided.
  - xvi. All types of detectors & devices offered shall have an inbuilt fault isolator. The fire detectors shall be plug in type. Suitable locking device shall be supplied along with each detector. It shall be inserted into or removed from the standard base by simple push twist mechanism to facilitate easy exchange / cleaning and maintenance.
  - xvii. The system shall have following self-diagnostic features:
  - xviii. Detector cabling shall be completely supervised for open circuit and short circuit and exact location of fault shall be displayed in the panel under Trouble/Faults.
  - xix. Un-authorized removal of a detector head from its base shall be supervised to give an alarm on the connected control panel.
  - xx. Annunciation shall be provided for DC fuse blown and loss of main AC supply etc.
  - xxi. Alarm verification features.

**b. ANALOGUE ADDRESSABLE FIRE ALARM CONTROL PANEL (FACP)**

The FACPs used in the Building shall confine to the EN54 standards having the following features:

**1. Features**

- i. All the FACPs provided shall have the capacity to expand from 1 to 4 loops for Future expansion.
- ii. Each loop shall accommodate maximum 240 detectors and devices in any combination with a loop length capable up to 1.6 kms with 2C x 1.5 sq mm cable.
- iii. It shall have facility to discriminate between a real fire alarm and a false alarm.
- iv. FACP will function as fully stand-alone panel & networked to other FACPs with peer-to-peer communication.
- v. Each FACP shall have inbuilt 8 Inch LCD colour touch screen (320\*240 pixels) to clearly indicate the location of fire, type of device activated other indications like service requirement of a component, etc.
- vi. The Panel shall have 200 Nos of Soft programmable keys with status indicators for individual triggering of NAC Outputs, evacuation speaker zones, AHU Modules, Damper switch, Smoke extraction Fans, Lifts, etc.
- vii. It shall have a provision for battery storage.
- viii. In case of a Loop Card Failure, the FACP shall allow to replace the Loop card without switching off the panel and reprogramming.
- ix. The FACP shall have facility such that alteration or access to the stored program shall be done through a pass-code, for protection against unauthorized personnel interference.

- x. The FACP shall be capable of PA Integration with the use of RS232 module or with the use of relays.
- xi. FACP shall have provision to accept 110V single phase, 60 Hz supply.
- xii. All the major components like processor, memory, etc., shall be available as spare in case of emergency requirement.
- xiii. FACP shall have inbuilt buzzer to alert the personnel in case of maintenance requirement.
- xiv. FACP shall be programmed for sequence of events to happen in case of fire like closing of fire dampers, shutting down supply fans for HVAC, Deactivating the access control system and activating the hooters with the help of a control relay module provided near the system to be activated.
- xv. The fire alarm control panel shall be suitable for Class-A type of wiring as per NFPA.
- xvi. The fire alarm control panel shall work on positive sequence as per NFPA.
- xvii. The fire alarm control panel shall be capable of disabling an individual detector, a group and or zone of for building maintenance purposes. Facility shall be provided on the FACP for simulating the fire condition to enable testing of the various alarm circuits.
- xviii. All the fire alarm modules (*loop cards, networking cards, and communication card. Etc.*) should be hot pluggable and hot swappable to facilitate easy replacement of faulty modules. All the electronic components shall be compatible to non-air-conditioned environment for working satisfactorily.
- xix. The fire alarm control panel normal power supply failure shall be annunciated audio-visually.
- xx. In case of multiple alarms, the multiple alarm indication shall be ON. The multiple alarm indication shall be displayed in chronological order.
- xxi. FACP shall have the facility such that each detector can be identified as a separate zone.
- xxii. The FACP shall be reset only by authorized users after the clearance of a fault.
- xxiii. Whenever there is a third party actuation to happen, like closing of fire dampers , switching off supply / exhaust units etc. , the actuation shall happen only when the fire signal is received from two different initiating devices located in a zone connected to different fire alarm panels. The communication between the FACP's shall happen with two pair cables and the fire alarm status of one panel shall be communicated to the second panel in which the control relay module of the third-party device is connected to. Inter panel communication is a must and needs to be provided for controlled actuations. All the necessary systems to ensure reliable communications between panels are to be built into the FACP's.
- xxiv. FACP shall have the facility to silence / acknowledge / reset the alarm. Apart from the FACP, Repeater panel present in the control room shall have the facility to silence / acknowledge / reset the alarm of all FACP's.
- xxv. The FACP shall have **FALSE ALARM REDUCTION** algorithms like

- xxvi. Alarm Verification, Dual Detector/Group Dependency, and Intermediate Alarm Storage to eliminate False alarms due to Dirt/Dust/Disturbance values.
- xxvii. EMC/EMI Monitoring - To inform the possibility of a false alarm caused due to interferences from sources such as Motors, power cables, Wi-Fi routers, fluorescent lamps, network switches, mobile signals...etc. The panel shall display the EMI/EMC Current and Average Values reported by the detector. The User/Installer shall have access to this reading during Maintenance (with password protection).
- xxviii. When fire condition is confirmed, the following sequence of annunciation will take place on the FACP:

a) Alarm Condition	b) Audible Alarm	c) Visual Alarm
First Fire Condition	ON	ON FLASHING/Description of area of fire origin with detector type
Acknowledge (first Alarm)	OFF	ON STEADY
New Fire Alarm Condition (after acknowledge of first alarm)	ON	ON FLASHING
Acknowledge (New fire alarm)	OFF	ON STEADY
Back to normal	OFF	ON STEADY
Reset	OFF	OFF
Reset Before Normal	OFF	ON STEADY

**2. Construction details**

- i. The FACP shall have an ingress protection of at least IP – 30.
- ii. The housing containing the fire alarm control panel shall be of 2 mm thick steel construction finished in colour as per relevant standard.
- iii. It shall be capable of being surface, semi-flush or fully flush mounted with additional bezel. The fully flush bezels shall be painted to specification, stainless steel or brass as required.

- iv. The FACP's shall be provided with triplicated earthing terminals on the either side. The grounding terminal G1 shall be for safety grounding, G2 shall be for shield grounding and G3 shall be for signal grounding.
- v. The panel shall be completely factory wired, absolutely ready-in all respects for installation at site and termination of all external cabling. The internal wiring of the panel shall be carried out with 650V grade, stranded copper wires of size rated for the current in the corresponding circuit. The minimum size of the wire shall not be less than 0.8 sq. mm for electronic circuits and 1.5 sq. mm for electrical circuits & 16 SWG for grounding.
- vi. All the wiring shall be done using ferrules having indelible marking.
- vii. Cable entry for the FACP from the bottom
- viii. FACP shall mount in wall.

### **3. CPU**

- i. The FACP shall have a processor which shall be of at-least 32 bits, which shall be designed to accept all the inputs and process the outputs within the time stipulated by the standards.
- ii. The CPU shall have the facility to communicate with other FACP's and process the fire signals received from other FACP's to actuate a third-party device.
- iii. The capacity of the processor shall be adequately designed include all input / output signals and various functional requirements.
- iv. The processor shall be designed in such a way that the parameters in the repeater panels shall be refreshed in 1 sec.
- v. It shall have its own, built in advanced microprocessor, sophisticated software and extensive memory for storing the logs of alarms, times and action taken report.

### **4. Loop Modules**

- i. The loop module shall have a microprocessor inbuilt & shall be capable of handling 240 detectors/devices in any combination.
- ii. It shall have a line length up to 1600m or 3000m depending upon the configuration & cable type.
- iii. It shall have an LED test button.
- iv. The loop module shall be encapsulated & shall be hot pluggable.
- v. The front fascia of the loop cards shall be visible for easy identification of faults.
- vi. In case of the failure of loop card, it should be replaced without the need of any additional programming.

## **5. REPEATER PANEL**

- i. Repeater Panel shall be an 8-inch LCD color touch screen same as main panel. The MMI shall be the same as the main Controller.
  - ii. It shall have inbuilt network ports for networking of Panels and Integrated Ethernet switch for networking and interfaces to remote services, building management and voice alarm systems
  - iii. Repeater panels shall be suitable for Wall mounting which will be displayed all the major entrances and stair cases which will enable the staff and firefighting personnel to exactly locate the fire.
  - iv. It shall be compatible to receive data from FACPs.
  - v. Audio visual Alarms during fire shall be generated in case of fire.
  - vi. It shall connect to any of the Fire Panels in the Network using a 2 core – 1.5 sq.mm wire.
  - vii. The Power supply to the Repeater Panel shall be drawn from the nearest Fire Panel and also be supervised by the Main Panel.
  - viii. The Repeater Panel shall display Messages like Alarm & Fault similar to the Main Panel and shall be accessed only by Authorized Users through a passcode.
  - ix. The Repeater Panel shall be connected to the Main Panel and other repeater panels in such a way – 1 pt. Failure in the cable shall not affect the performance and shall intimate the exact location of failure in all Panels.
  - x. The Repeater Panel shall be equipped with a Key switch that allows Authorized users to Acknowledge/Reset Alarms.
  - xi. The Repeater Panel shall be equipped with 2 different power inputs. On failure of primary power, the secondary shall take over.
  - xii. The Repeater panel shall allow the users to login locally or login to the remote FACP.
  - xiii. The Repeater panel shall allow to create users with different access levels locally and shall also allow users of panels to login based on access levels.
  - xiv. The repeater panels shall integrate with the main panels without any additional interface or the bidder shall consider necessary accessories required to complete the system and quote as part of this model.
- c. INTELLIGENT ADDRESSABLE OPTICAL SMOKE / HEAT DETECTOR (MULTI SENSOR) DETECTOR**
- i. The Intelligent Addressable Multi sensor Detector with 2 LED's-Infrared & Blue used in this Building shall confine to the relevant standards having the following features
  - ii. It shall be combination of Smoke detection and heat detection. The smoke detection system shall work on Light scattering type principle using Infrared & Blue Led's, and the Heat detection system shall be of Rate of rise of temperature and Fixed Temperature.
  - iii. The Intelligent Addressable Multi sensor Detector shall be of Spot type and Addressable type.

- iv. The Intelligent Addressable Multi sensor Detector shall be addressed either by DIP switches or through Programming from the Panel.
- v. The Detector shall monitor EMC/EMI values in the surroundings on a continuous basis and report the current & average values to the panel. The detector and the panel shall together avoid the possibility of false alarm caused due to interferences from sources such as Motors, power cables, Wi-Fi routers, fluorescent lamps, network switches, mobile signals...etc.
- vi. All the detectors shall have a visible multi-color LED to indicate the healthiness / trouble / alarm condition of the detector. The LED shall be located in such a way that it shall be visible from all the 360 degree from below. In some cases where the visibility of the detector is obstructed by cable trays, false ceiling etc. Facility for connecting the detector to a response indicator has to be present. The response indicator derives the power to glow from the loop.
- vii. It shall possess False alarm immunity and a superior signal to noise ratio
- viii. It shall have a Built-in signal processor
- ix. It shall be with inbuilt fault isolators. (Detectors without Inbuilt Isolators may be considered with separate Isolator Base)
- x. It shall have drift compensation facility built in.
- xi. The detectors shall communicate the ambient reading to the FACP on time to time basis, and the FACP shall make the decision about the current status of the detector, whether it is in fire/pre-alarm/maintenance requirement etc.
- xii. The detector shall have at least 15 levels of sensitivity settings based on the application and room where it is installed.
- xiii. The detector shall provide a chamber maid plug to blow out the dust/dirt using a blower.
- xiv. In case of a failure, panel shall allow to replace the detector with the same type without the need of additional programming
- xv. The detector shall be programmed to work as Optical only or Thermal only detectors. It shall a provision to switch off any component (optical or thermal) of the detector.
- xvi. The detector shall work with 2 different sensitivity settings at any point of time and the User shall have access to choose the desired settings without programming or Laptop/PC for configuration.
- xvii. The detector shall change sensitivity settings based on day/night mode or with schedules based on the programming.
- xviii. The detector shall have Intermediate Alarm Storage, Dual Detector Dependency, Dual group Dependency features that shall be programmed based on site application.
- xix. The detector shall be capable of detecting both smoldering fires and open fires and shall be EN54 / UL approved.

d. INTELLIGENT ADDRESSABLE DUAL OPTICAL SMOKE DETECTOR WITH 2 LED's-  
INFRARED & BLUE.

- i. The Intelligent Addressable Photo electric smoke Detector with 2 LED's-Infrared & Blue used in this Building shall confine to the relevant standards having the following features
- ii. The smoke detection system shall work on Light scattering type principle using Infrared & Blue Led's.
- iii. The Intelligent Addressable Smoke Detector shall be of Spot type and Addressable type.
- iv. The Intelligent Addressable Smoke Detector shall be addressed either by DIP switches or through Programming from the Panel.
- v. The Detector shall monitor EMC/EMI values in the surroundings on a continuous basis and report the current & average values to the panel. The detector and the panel shall together avoid the possibility of false alarm caused due to interferences from sources such as Motors, power cables, Wi-Fi routers, fluorescent lamps, network switches, mobile signals...etc.
- vi. All the detectors shall have a visible multicolor LED to indicate the healthiness / trouble / alarm condition of the detector. The LED shall be located in such a way that it shall be visible from all the 360 degree from below. In some cases where the visibility of the detector is obstructed by cable trays, false ceiling etc. Facility for connecting the detector to a response indicator has to be present. The response indicator derives the power to glow from the loop.
- vii. It shall possess False alarm immunity and a superior signal to noise ratio
- viii. It shall have a Built-in signal processor
- ix. It shall be with inbuilt fault isolators. (Detectors without Inbuilt Isolators may be considered with separate Isolator Base)
- x. It shall have drift compensation facility built in.
- xi. The detectors shall communicate the ambient reading to the FACP on time to time basis, and the FACP shall make the decision about the current status of the detector, whether it is in fire/pre-alarm/maintenance requirement etc.
- xii. The detector shall have at least 3 levels of sensitivity settings based on the application and room where it is installed.
- xiii. The detector shall provide a chamber maid plug to blow out the dust/dirt using a blower.
- xiv. In case of a failure, panel shall allow to replace the detector with the same type without the need of additional programming
- xv. The detector shall work with 2 different sensitivity settings at any point of time and the User shall have access to choose the desired settings without programming or Laptop/PC for configuration.



- xvi. The detector shall change sensitivity settings based on day/night mode or with schedules based on the programming.
- xvii. The detector shall have Intermediate Alarm Storage, Dual Detector Dependency, Dual group Dependency features that shall be programmed based on site application.
- xviii. The detector shall be capable of detecting both smoldering fires and open fires and shall be EN54 /UL approved.

e. INTELLIGENT ADDRESSABLE HEAT DETECTOR

- i. The Intelligent Addressable Heat Detector used in this Building shall confine to the relevant standards having the following features
- ii. The Heat detection system shall be of Rate of rise of temperature and Fixed Temperature.
- iii. The Heat Detector shall be of Spot type and Addressable type.
- iv. The Heat Detector shall be addressed either by DIP switches or through Programming from the Panel.
- v. The Detector shall monitor EMC/EMI values in the surroundings on a continuous basis and report the current & average values to the panel. The detector and the panel shall together avoid the possibility of false alarm caused due to interferences from sources such as Motors, power cables, Wi-Fi routers, fluorescent lamps, network switches, mobile signals...etc.
- vi. All the detectors shall have a visible multi-color LED to indicate the healthiness / trouble / alarm condition of the detector. The LED shall be located in such a way that it shall be visible from all the 360 degree from below. In some cases where the visibility of the detector is obstructed by cable trays, false ceiling etc. Facility for connecting the detector to a response indicator has to be present. The response indicator derives the power to glow from the loop.
- vii. It shall possess False alarm immunity and a superior signal to noise ratio
- viii. It shall have a Built-in signal processor
- ix. It shall be with inbuilt fault isolators. (Detectors without Inbuilt Isolators may be considered with separate Isolator Base)
- x. It shall have drift compensation facility built in.
- xi. The detectors shall communicate the ambient reading to the FACP on time to time basis, and the FACP shall make the decision about the current status of the detector, whether it is in fire/pre-alarm/maintenance requirement etc.
- xii. In case of a failure, panel shall allow to replace the detector with the same type without the need of additional programming
- xiii. The detector shall work with 2 different sensitivity settings at any point of time and the User shall have access to choose the desired settings without programming or Laptop/PC for configuration.

- xiv. The detector shall change sensitivity settings based on day/night mode or with schedules based on the programming.
- xv. The detector shall have Intermediate Alarm Storage, Dual Detector Dependency, Dual group Dependency features that shall be programmed based on site application.
- xvi. The detector shall be capable of detecting both smoldering fires and open fires and shall be EN54 /UL approved.

**f. ADDRESSABLE VENTILATION DUCT SMOKE DETECTORS**

- i. The detector shall have a housing for accommodating a special detector that detects smoke in ventilation ducts, with input and output for air sample extraction, streamlined connection pipes for optimum air flushing of the detector, with dust-proof connection board for the loop outside the air flow, with air intake and exhaust pipe, seals and the required installation material
- ii. The Duct smoke Detector used in this Building shall confine to the relevant standards having the following features
- iii. The smoke detection system shall work on Light scattering type principle using Infrared. The detector shall better false alarm immunity and shall have a processor inbuilt with ISP.
- iv. Duct Detector shall be Addressable type.
- v. The Dual Detector shall be loop powered and addressed either by DIP switches or through Programming from the Panel.
- vi. All the detectors shall have a visible multi-color LED to indicate the healthiness / trouble / alarm condition of the detector. The LED shall be located in such a way that it shall be visible from all the 360 degree from below. In some cases where the visibility of the detector is obstructed by cable trays, false ceiling etc. Facility for connecting the detector to a response indicator has to be present. The response indicator derives the power to glow from the loop.
- vii. It shall possess False alarm immunity and a superior signal to noise ratio
- viii. It shall have a Built-in signal processor
- ix. It shall be with inbuilt fault isolators. (Detectors without Inbuilt Isolators may be considered with separate Isolator Base)
- x. It shall have drift compensation facility built in.
- xi. The detectors shall communicate the ambient reading to the FACP on time to time basis, and the FACP shall make the decision about the current status of the detector, whether it is in fire/pre-alarm/maintenance requirement etc.
- xii. The detector shall have at least 3 levels of sensitivity settings.
- xiii. The detector shall provide a chamber maid plug to blow out the dust/dirt using a blower.

- xiv. In case of a failure, panel shall allow to replace the detector with the same type without the need of additional programming
- xv. The detector shall work with 2 different sensitivity settings at any point of time and the User shall have access to choose the desired settings without programming or Laptop/PC for configuration.
- xvi. The detector shall change sensitivity settings based on day/night mode or with schedules based on the programming.
- xvii. The detector shall have Intermediate Alarm Storage, Dual Detector Dependency, Dual group Dependency features that shall be programmed based on site application.
- xviii. The detector shall have Air intake and exhaust pipe, extendable up to 3m
- xix. The detector shall have necessary filters in the air intake and exit pipes.
- xx. The detector considered shall be a special detector designed for Duct applications and not a Spot type Optical detector.
- xxi. The detector shall be EN54 /UL approved.

g. **MANUAL CALL POINTS**

- i. The Manual call points (MCP) used in the building shall confine to the relevant standards having the following features
- ii. Manual call points shall be of Double action - break glass type with Push Button.
- iii. The mounted arrangement shall be such that it can be either surface mounted or flush mounted.
- iv. Each addressable MCP will comprise of an electronic circuit built into it to provide addressing capability.
- v. The MCPs shall be provided with inbuilt fault isolator. (the bidder shall consider a external isolator if not inbuilt)
- vi. The MCP shall have a LED to indicate Alarms
- vii. The MCP shall be EN54/UL approved

h. **CONTROL RELAY MODULE (CRM)**

- i. The Control Relay Modules used in this Building shall confine to the relevant standards having the following features
- ii. The CRM shall provide a dry potential contact o/p for activating a variety of auxiliary devices and other firefighting / ventilation equipment.
- iii. The CRM shall have inbuilt fault isolator module. (bidder shall consider external isolators if not inbuilt)
- iv. It shall have a capability of handling at least 1A @ 30VDC to integrate with third party system.
- v. The CRM shall be addressable either by Dip switch or by the Panel.

vi. The CRM shall be loop powered and shall be EN54/UL approved.

i. **MONITOR MODULE (INPUT MODULE) (MM)**

- i. The Monitor Modules used in this Building shall confine to the relevant standards having the following features
- ii. The MM shall provide 2 inputs and these inputs shall work independently to monitor 3<sup>rd</sup> party devices and shall allow to program with different parameters.
- iii. The MM shall have inbuilt fault isolator module. (bidder shall consider external isolators if not inbuilt)
- iv. The MM shall be programmed to monitor contacts, Voltage and EOL resistor as per site applications.
- v. The MM when programmed to monitor contacts shall also allow to program to monitor either open/close contacts.
- vi. The MM shall be addressable either by Dip switch or by the Panel.
- vii. The MM shall be loop powered and shall be EN54/UL approved.

j. **SOUNDER**

- i. The Sounder used in this Building shall confine to the relevant standards having the following features
- ii. The Sounder shall be an Addressable loop powered sounder. (Bidder shall consider external power supply, cable, conduits, modules required for activating externally powered sounders and include the costing as part of the item – Sounders)
- iii. The Sounder shall have inbuilt fault isolator module. (bidder shall consider external isolators if not inbuilt)
- iv. The Sounder shall either be addressed by Dip switch or by the Panel.
- v. The Sounder shall be placed in the detection loop only and a separate loop or cables for sounders shall not be used
- vi. The sounder shall have a sound pressure level of 90dB and the volume shall be adjusted from the Fire Alarm Panel
- vii. The sounder shall be capable of programming at least 32 different tones for alarm detection in different floors or at different time intervals.
- viii. The sounder shall be tested and maintained with ease from the FACP
- ix. The Volume levels for Testing and Drill shall be programmed as per site conditions.
- x. The Sounder shall consume a minimal current of <5mA and thus allowing to connect at least 25 loop powered sounders in the same loop.
- xi. The Sounder shall be capable of either accommodating a Flasher or a Detector and shall work as Sounder cum strobe or Sounder cum detector base.
- xii. The Sounder shall have a feature of synchronizing with other sounders in the loop.
- xiii.** The Sounder shall be loop powered and shall be EN54/UL approved.

**k. STROBE**

- i. The Strobe used in this Building shall confine to the relevant standards having the following features
- ii. The Strobe shall be an Addressable loop powered Strobe. (Bidder shall consider external power supply, cable, conduits, modules required for activating externally powered Strobes and include the costing as part of the item – Strobes)
- iii. The Strobe shall have inbuilt fault isolator module. (bidder shall consider external isolators if not inbuilt)
- iv. The Strobe shall either be addressed by Dip switch or by the Panel.
- v. The Strobe shall be placed in the detection loop only and a separate loop or cables for Strobe shall not be used
- vi. The Strobe shall have a red flash light and shall flash at minimum of 1Hz
- vii. The Strobe shall be tested and maintained with ease from the FACP
- viii. The Strobe shall also be part of Testing and Drill and shall be programmed as per site conditions.
- ix. The light output shall be at least 2 cd
- x. The Strobe shall consume a minimal current of 10mA and thus allowing to connect at least 10 loop powered strobes in the same loop.
- xi. The Strobe shall be capable of either fixing it in a Sounder and shall work as Sounder cum strobe as per site conditions.
- xii. The Strobe shall be loop powered and shall be EN54/UL approved.

**l. REMOTE INDICATOR**

- i. The Remote indicator used in this Building shall confine to the relevant standards having the following features
- ii. The remote indicator is used when the automatic detector is installed in a place hidden or not visible like in closed rooms, false ceilings or walls
- iii. The remote indicator should be 360° view, for both wall mount and ceiling mount.
- iv. The remote indicator shall be IP 40 rating.

**m. GRAPHICAL USER INTERFACE SOFTWARE.**

- i. Fire Graphics software shall be with lifetime license to map, monitor (alarms & faults) & control all the detector and devices connected to all the Fire alarm panel.
- ii. The fire Graphics software shall be loaded on the PC connected to the Fire alarm panel.
- iii. The GUI based main network software shall network with other panels on True Peer-to-Peer network.

- iv. It shall be capable of graphically representing each facility being monitored with floor plans and icons depicting the actual locations of the various systems, and / or sensors' locations.
- v. It shall have the facility to change the sensitivity of any detector.
- vi. The software shall have minimum 2000 Points + 20% for future expansion.

C. PUBLIC ADDRESS SYSTEM

a. GENERAL PUBLIC ADDRESS SYSTEM DESCRIPTION

The system shall provide new and unique features for the market. Each component in the system shall be designed to suit the system needs as required.

The system shall have the following features:

1. Easy configuration, but without losing the ability to solve complex requests. A basic mode configuration wizard and an expert mode program interface shall be provided. Fast and correct installation shall be possible, but it shall also be possible to handle complex and specific application requirements.
2. A free programmable software shall be available via the expert mode program interface. The basic mode wizard shall be able to provide a step-by-step configuration guide that creates a complete system configuration file.
3. Due to its flexibility, the system shall eliminate the project risk right from the start. The matrix structure shall be evident throughout the system. Dynamic routing and intelligent audio power distribution shall make the system suitable for almost any application. The system shall be designed to ensure a system-wide intelligent power management architecture. The system shall raise the bar and creates a PA/EVAC system that uses the lowest power consumption for the application without losing functionality. It shall save batteries and maintenance costs!
4. The system shall be built by professional sound engineers, and shall add pro-sound audio quality level to the PA/EVAC system. This high-quality level shall enable combined use of Fire/EVAC with applications that requires high-quality audio, such as presentation rooms, school stages, etc. The excellent sound quality shall ensure excellent intelligibility in all kind of situations.
5. The new Call station shall be designed as a modern device. The new call station shall provide a green LED on the Microphone in to show that a call is going across from the call station. The system shall be able to handle up to 16 call stations
6. The system shall be capable to address 400 zones or more with a total speaker load up to 35000 Watt. It shall be able to handle 3 system sources and up to 15 music sources including local source inputs.
7. It shall be possible to have just one spare amplifier in the system to take over from a duty amplifier in case one fails.

**D. SYSTEM CONTROLLER**

- i. The system controller shall be an EN54-16 compliant and certified device in a 2 RU, 19"-cabinet. The TCP/IP capable network device shall contain all controlling and monitoring functions of a voice evacuation system.
- ii. The controller shall manage the supervision of its own operation and that of the connected devices. It shall control and activate the connected amplifiers and spare amplifier and shall replace the amplifier routing and channel that has reported a fault. A failsafe mode shall ensure that emergency calls are passed through to the amplifiers even if the controller itself fails.
- iii. The controller shall support single line switching or redundant group A/B switching.
- iv. Network connectivity status and fault conditions shall be displayed via LEDs on the front panel.
- v. >1000 fault, warning and event conditions shall be logged internally and it shall be reported with the possibility to look real-time into the logging and save the log with logging tools. Four 100V audio inputs shall be routed to 6 speaker line outputs. It also shall have an option to have multiple calls in parallel in a 2-channel operation mode.
- vi. In case of too much amplifier power, it shall be possible to also transfer overrun amplifier power to additional system routers.
- vii. The controller shall provide an internal Audio matrix with full DSP functionality on each output. The controller shall operate minimum two or more channel output matrix.
- viii. It shall be possible to adjust channel delays up to 10s per channel.
- ix. A single system controller shall be able to manage up to 15 routers, 14 call stations and up to 400 loudspeaker circuits.
  - x. It shall allow up to 4 or more controllable local audio inputs.
- xi. A built-in message manager shall be able to store up to 85 emergency- or business-calls, with a total storage time up to 85 minutes.
- xii. It shall be possible to send two different messages simultaneously to individual destinations.
- xiii. In combination with license free spoken word evac sound files shall be provided in 7 languages.
- xiv. A separate included tool shall provide on the fly replacing non-evac messages at any time without system interruption or system restart; So, called hot swappable messages.
- xv. Loudspeaker supervision shall be fully controlled by the controller and executed from the router. The user shall be able to choose between impedance measurement, simple EOL boards with pilot tone supervision (requires return wires) or via advanced addressable EOL supervision boards, which requires a ground connection but no additional return wires.
- xvi. Zones outputs shall be able to handle a load from 2-500 Watt.

- xvii. Max 500 Watt per 6 zones shall be provided, if required.
- xviii. The controller shall be able to handle up to 1500 Watt or more load.
- xix. It shall be possible to use connect to a fire alarm system via Ethernet or contact input
- xx. The controller shall have the following specifications:
  - a. DSP matrix mixing
  - b. Priority mixing with ducking, attack and release
  - c. 3 band parametric PEQ in the inputs
  - d. 5 band parametric PEQ in the outputs
  - e. up to 10s delay per output
  - f. Gain adjustment in the in- and outputs
  - g. Compressor on the inputs
  - h. Limiters on the inputs
  - i. Cross point matrix level adjustment with ducking level, fade in and fade out time
  - j. 2 mic/line inputs (System s/n  $\geq$  106dB) – 2x Euro Style - 2x cinch
  - k. 4 separate call station RJ45 input busses, each can be daisy chained up to 4 call stations
  - l. 4 output channels for daisy chaining amplifiers via RJ45
  - m. 12 input contacts; 6x voltage free (isolated) + 6x Supervised, to ensure compliancy to all different standards (like VDE0833 & NEN2575)
  - n. 12 output contacts; 1x Relay + 12 Open Collector
  - o. 6 High power output contacts (1A)
  - p. 8 Analog input contacts with 256 steps resolution
  - q. Four input channels (100V, 70V) + 2 spare channel inputs (100V, 70V)
  - r. Real time clock with summertime and wintertime switching
  - s. DCF77 receiver sync input
  - t. Event scheduler
  - u. 6 zone outputs (100/70V)
  - v. System status LED (general fault, system fault, alarm mode, power indicator, standby mode, network connection status)
  - w. Controller shall be configurable as A/B zones or 10 single zones
  - x. Internal sounder
  - y. System access shall have password protection
  - z. Based on a fully digital platform
  - aa. Network prepared (remote system racks)
  - bb. 24V DC Input

Audio: 14 or better (internal) audio Channels  
2 or more Aux input channels  
4 CallStation input channels  
4 audio output channels



Safety:	Internal supervision, system monitoring, watchdog, fault output
Software:	Free Basic mode (Wizard) & expert Mode software Intelligent Remote & Integrated Supervision Net)  Integration of controller, amplifiers, call stations and peripheral control  Configuration, control and supervision for complete audio systems  Message swapper  Programmable user control,  GUI and access levels
Audio input specifications:	+6dBu/ 1,55V
Audio output specifications:	+6dBu/ 1,55V
Frequency response:	20Hz to 20kHz (-0,5dB)
Signal-to-noise ratio (A-weighted):	analog in to analog out: >106 dB typical
THD+N:	0.01%
Crosstalk:	>100dB @ 1 kHz
Sample rate:	48 kHz; 24bit
DSP Processing:	3 DSPs (480 MIPS) internal
Ethernet:	10/100 MB, RJ-45 (PC control)
CAN:	10 to 500 kbit/s, 2x RJ-45  (remote and control)
Networking:	Module slot for optional Network / OMNEO interface
Control Port:	1 slave clock output (max. 1 A)  1-time sync input (DCF-77 standard)  12 control inputs (logic control)

	12 control outputs
	6 analog inputs 0-10V
Power supply:	+24 V DC (wide range tolerance: 18 V to 58 V DC)
Operating temperature:	-5 C to +45 C
Product dimensions (W x H x D):	19", 2 HU, 483 x 88 x 376 mm
Colour:	Black / Silver
Weight:	3.5 kg

#### E. AMPLIFIER

- i. The 2 x 480W or better Class D, high efficiency amplifier shall be an EN54-16 compliant and certified system device in a 2 RU, 19" cabinet. It shall provide 70/100V loudspeaker output voltages that are galvanically separated. The amplifier shall be permanently monitored by the system controller.
- ii. A special standby mode shall be provided for saving energy during the time the amplifier is not in use with respect to all economical and supervision aspects.
- iii. System control and audio interconnections shall be done via RJ45 connectors.
- iv. The amplifier shall be used as a system amplifier, but it shall also be possible to use the amplifier standalone.
- v. As a system amplifier, four automatic selectable audio inputs via RJ45 shall be available. It shall also be possible to use a local input, and as such shall provide local (non-system controlled) sources without losing system and line supervision.
- vi. It shall be a requirement that local input is used in case of standalone mode.
- vii. The local input shall be configurable in a way that it can be used in as source input for in an installed system, for example for an external PA or local source input. The amplifier shall have the following specifications:
  - a. 2x 480-Watt Class D amplifier
  - b. 4 channel input on RJ45 connector, amp link in and out (4 channel dynamic input channel switching for each amplifier)
  - c. Local input on amplifier: Enabled via software configuration or automatically selected when amplifier address is set to address "0", System channel 4 will be used as supervision channel in case local inputs are used.
  - d. Loop through on RJ45 connector (4 channels)
  - e. Amplifier efficiency  $\geq 78\%$
  - f. Limiter prevents audible distortion
  - g. AC Power switch on rear side

- h. 24V DC Input
- i. Front to rear air ventilation

Max amplifier load:	2x 480Watt
Signal to noise ratio, A-weighted:	>104 dB
Power requirements:	100 – 240 VAC in, IEC non-locking socket, 50 to 60 Hz or 24 VDC in (20 - 28 VDC)
Product dimensions (Width by Height by Depth):	19", 2RU, 483 by 88.1 by 374.8 mm
Color:	Black/Sliver

#### F. CALL STATION

- i. The call station shall be an EN54-16 compliant and certified user interface.
- ii. It shall be designed in a modern and robust chassis with a graphical display.
- iii. As standard, the call station shall have a gooseneck microphone with pop shield and permanent monitoring, an illuminated LC-display and an integrated loudspeaker to be used for system sounds.
- iv. The operation status shall be permanently supervised by the system controller.
- v. It shall be possible to modify the call station to suit the user's requirements by connecting up to five remote call station extensions, each with 20 free customizable functions and selection buttons.
- vi. It shall be possible to extend the call station extension at the right and at the left side. It shall be possible to mount a maximum of 3 additional emergency buttons on the Call station. Optionally it shall be possible to mount a key switch to lock or enable call station functions with a key switch or to give access to a second access level.
- vii. The Call station shall have a built-in numerical keypad; it shall be possible to enable or disable the keypad during configuration.
- viii. The call station shall have the following specifications:
  1. Five menu/function keys (pre-programmed) – four buttons shall provide each 1 LED (two LED's shall be 2 green and 2 LED's shall be yellow).
  2. Green led on the microphone which is active during a call
  3. 12 function and speed dial buttons (customizable), two LEDs (green/red) per button.
  4. Button functions shall be programmable such as:
    - a. Zone select, source select, level control, emergency on/off, message on/off, failure acknowledge/reset.

- b. switching output trigger on/off or 0 to 10V, select scheduled events, scheduled event on/off.
- 5. Fascia cover with transparent areas for customizable labels.
- 6. Multilanguage LCD display informs about system status, system faults, selected zones, source select, clock, different kind of additional (failure) messages shall be free configurable.
- 7. Supervised electret microphone, with limiter and a speech filter for excellent speech intelligibility.
- 8. CAT5 cable for data and audio connection to controller (can bus, up to 1000 meter).
- 9. It shall be possible to daisy chain 4 call stations.
- 10. It shall receive audio and operational control signals from the controller and report its status to the system controller.
- 11. Internal monitoring with error logging– complying with all relevant national and international standards.

Supply voltage:	15–58 V DC
Maximum supply current (without extensions):	< 80 mA / 24 V < 110 mA / 18 V
Maximum supply current (with 5 extensions):	< 180 mA / 24 V < 250 mA / 18 V
Maximum mic input level:	-21 dBu
Maximum line input level:	+4 dBu
Maximum NF output level:	+12 dBu
LC-Display:	Lighted (122 x 32 pixel)
External Connectors:	1 PCA BUS connector (Control data + Audio + Power supply, RJ-45)  1 Audio Source (Line level, phone jack)  1 Microphone input (phone jack)  1 EXT connector (call station extension, RJ-12)
Operating temperature:	-5° to 45° C
Product dimensions (Width by Height by Depth):	200 by 167 by 65 mm

	(without microphone)
Color:	black
Net weight:	0.6 kg

## G. LOUDSPEAKERS

### Ceiling Type Loudspeaker

A flush-mounting ceiling loudspeaker is available for general application. These full range loudspeakers are suitable for both speech and music reproduction. The speaker assembly consists of a single piece, 6 W loudspeaker and frame with a 100 V matching transformer mounted on the back.

Technical Specifications are as follows:

Maximum power	9 W
Rated power	6W
Sound pressure level at 6 W / 1 W (1 kHz, 1 m)	98 dB / 88 dB (SPL)
Effective frequency range (-10 dB)	100 Hz to 18 kHz
Rated voltage	100 V
Rated impedance	1667 $\Omega$

### H. CABINET (Wall Mount) Loudspeaker

A wall-mounting loudspeaker is available for general application. These full range loudspeakers are suitable for both speech and music reproduction. The speaker assembly consists of a single piece, 6 W loudspeaker and frame with a 100 V matching transformer mounted on the back.

Technical Specifications are as follows:

Maximum power	9 W
Rated power	6W (6 – 3 – 1.5W)

Sound pressure level at 6 W / 1 W (1 kHz, 1 m) 94 dB / 88dB (SPL)

Effective frequency range (-10 dB) 220Hz to 15 kHz

Rated voltage 100 V

Rated impedance 1667  $\Omega$

Opening angle at 1 kHz/4 kHz (-6 dB) 150° / 70°

### I. CCTV System

The objective of CCTV system is to provide video surveillance and recording function for the Hospital operators to monitor strategic area to secure the safety and security of the public and staff.

#### a. General Requirements for CCTV System

The CCTV system shall be used for observation of public movement for security, disaster measures. According to them, the basic requirements for CCTV system shall be as follows

#### b. Monitoring Patients and Public Movement

The CCTV camera shall be installed at a different location like entry exit ,waiting area etc for the purpose of monitoring of public services, including patients .

#### c. Bullet Camera

Image Sensor	1/2.7", progressive scan,4.0 megapixel, CMOS
Lens	2.8~12mm, AF automatic focusing and motorized zoom lens
Iris	DC-Iris
Angle of View (H)	96.4°~27.0°
Day/Night	IR-cut filter with auto switch (ICR)
Shutter Speed	1/30~1/100000 s
Min.Illumination	0.008 lux (F1.6,AGC ON) 0 Lux with IR
IR	50 m
S/N	> 52dB

WDR	120dB
AWB(Auto White Balance)	Auto/Natural/Street Lamp/Outdoor/Manual
Digital Zoom	16x
Noise Reduction	2D/3D DNR
Defog	Digital Defog

**d. Video**

Video Compression	Smart H.265, H.265+,H.265, H.264, MJPEG
H.264 Code Profile	Baseline profile, Main Profile, High Profile
Frame Rate	30fps
Video Bit Rate	128Kbps-10Mbps
HLC	Supported
BLC	Supported
OSD	Up to 4 OSDs
Motion Detection	Up to 4 areas
ROI (Region of Interest)	of Up to 4 areas
Privacy Masking	Up to 4 areas

**e. Audio**

Audio Compression	G.711
Two-way Audio	Supported
Suppression	Supported
Sampling Rate	8 KHZ

**f. Smart Features**

Intrusion	Supported
-----------	-----------

Cross Line	Supported
Intelligent Identification	Object abandoned/missing detection, region entrance/exiting/intrusion Detection (human/vehicle classification), line crossing detection (human/vehicle classification), video tampering detection, scene change detection, face detection, face capture, crowd density detection, heat map, human/vehicle counting, human tracking
General function	Watermark, IP Address Filtering, Tampering Alarm, Access Policy, ARP Protection, User Authentication, heartbeat, Video masking
Image Settings	Rotate Mode, Saturation, Brightness, Contrast, Sharpness adjustable by client software or web browser

**g. Storage**

Edge Storage	Micro SD, up to 128 GB/256 GB (optional)
Network Storage	NAS (Network Attached Storage) Local PC for instant recording

**h. Interface**

Audio I/O	1CH audio input, 1CH audio output
Alarm I/O	1CH IN/ 1CH OUT
Network	1 RJ45 10M/100MBase-TX Ethernet
Built-in Mic	Supported

**i. General**

Power	12 V DC±25%, PoE
Power Consumption	Max 10 W
Working Humidity	Humidity ≤ 95% RH (non-condensing)
Working Environment	-30°C to 60°C
Ingress Protection	IP67
Vandal Resistance	IK10
Dimension	253.4 ×86 ×71.7 mm (9.98" × 3.4" × 2.8")



## J. DOME Camera

Image Sensor	1/3", 3-megapixel, progressive scan CMOS
Lens	2.8 mm@F2.0 horizontal field of view 104.4°
Day/Night	2.8 mm@F2.0 horizontal field of view 104.4°
Shutter Speed	Auto/Manual, 1~1/100000 s
Min.Illumination	Color: 0.01Lux (F2.0, AGC ON); 0 Lux with IR
IR	30m(98ft) IR Range
S/N	> 55dB
WDR	120Db
Digital Zoom	16x
Noise Reduction	3D DNR
Defog	Digital Defog

### a. Video

Video Compression	H.265+( Smart Encode) ,H.265, H.264, MJPEG
Frame Rate	Main Stream: 4MP (2592×1520): Max. 20 fps; 4MP (2560×1440): Max. 25 fps 3MP (2048×1520): Max. 30 fps; Sub Stream: 2MP (1920*1080), Max 30fps; Third Stream: D1 (720*576), Max 30fps
9:16 Corridor Mode	Supported
OSD	Up to 8 OSDs
Motion Detection	Up to 4 areas
ROI (Region of Interest)	Up to 8 areas

Privacy Up to 8 areas  
 Masking

**b. Audio**

Audio G.711  
 Compression

Two-way Audio Supported

**c. Smart Features**

General function Watermark, IP Address Filtering, Tampering Alarm, Access Policy, ARP Protection, User Authentication, heartbeat, Video masking

Image Settings ROI, Saturation, Brightness, Chroma, Contrast Wide Dynamics, Sharpen, NR, etc. adjustable through Client Software or Web browser

**d. Storage**

Edge Storage Micro SD, Up to 256GB

Network Storage ANR, NAS(NFS)

**e. Network**

Protocols IPv4, IGMP, ICMP, ARP, TCP, UDP, DHCP, PPPoE, RTP, RTSP, RTCP, DNS, DDNS, NTP, FTP, UPnP, HTTP, HTTPS, SMTP, 802.1x, SNMP, QoS

Compatible Integration ONVIF (Profile s, Profile G, Profile T), API

**f. Interface**

Audio I/O Input: impedance 35 kΩ; amplitude 2 V [p-p] Output: impedance 600 Ω; amplitude 2 V [p-p]

Alarm I/O 1/ 1

Network 10M/100MBase-TX Ethernet

**General**

Power 12 V DC, or PoE Power consumption: Max 5.5 W

Power Consumption Power consumption: Max 5.5 W

Working Humidity Humidity  $\leq$  95% RH(non-condensing)

Working Environment -35°C to 60°C (-31°F to 140°F)

Ingress Protection IP67

Vandal Resistance IK10

### **PTZ Camera**

Image Sensor 1/2.8", progressive scan, 2.0 megapixel, STARVIS CMOS

Lens 3.95 ~ 177.7 mm (45x optical zoom) , AF automatic focusing and motorized

Iris Auto/Manual; F1.6 ~ F4.95

Angle of View (H) 70.3° (wide) ~ 1.8° (tele)

Day/Night IR-cut filter with auto switch (ICR)

Shutter Speed Auto/Manual, 1/1s ~ 1/30000 s

Min.Illumination Color: 0.001 Lux (F1.6, AGC ON) 0 Lux with IR

IR 250m (820 ft)

S/N 55dB

WDR 120dB

Digital Zoom 16x

Noise Reduction 2D/3D DNR

Defog Digital Defog

### **Video**

Video Compression Smart H.265, H.265, H.264, MJPEG

H.264 Code Profile Baseline profile, Main Profile, High Profile

Frame Rate 60fps

HLC Supported

BLC Supported

Motion Detection Supported

Privacy Masking Up to 24 areas

### Audio

Audio Compression G.711a/G.711Mu/AAC/G/722/G.726/G.729/MPEG2-L2

Two-way Audio Supported

### Smart Features

Intelligent Identification Tripwire, Intrusion, Abandoned/Missing, Face detection, Heat Map

General function Watermark, IP Address Filtering, Tampering Alarm, Access Policy, ARP Protection, RTSP Authentication, User Authentication

Image Settings Rotate Mode, White Balance, Gain Control, Saturation, Brightness, Contrast, Sharpness adjustable & Auto mode

### Storage

Edge Storage Micro SD, up to 256 GB

Network Storage ANR, NAS

### Network

Protocols IPv4, IPv6, IGMP, ICMP, ARP, TCP, UDP, DHCP, PPPoE, RTP, RTSP, RTCP, DNS, DDNS, NTP, FTP, UPnP, HTTP, HTTPS, SMTP, 802.1x, SNMP, IP Filter, QoS, Bonjour

Compatible Integration ONVIF (Profile S, Profile G), API

### Interface

Audio I/O Audio cable Input: impedance 35 k $\Omega$ ; amplitude 2 V [p-p] Output: impedance 600  $\Omega$ ; amplitude 2 V [p-p]

Alarm I/O 7IN / 2Out

Network 1 RJ45 10M/100MBase-TX Ethernet

Video Output 1 BNC, impedance 75  $\Omega$ ; amplitude 1 V [p-p]

### General

Power 24 V AC (Default)  $\pm 25\%$ , 24 V DC $\pm 25\%$

Power Consumption 16 ~ 56W

Working Temperature  $-40^{\circ}\text{C} \sim +70^{\circ}\text{C}$  ( $-40^{\circ}\text{F} \sim 158^{\circ}\text{F}$ )

Working Humidity  $\leq 95\%RH$  (non-condensing)

Ingress Protection IP67

Vandal Resistance IK10

Dimension  $\varnothing 270 \times 496.7$  mm ( $\varnothing 8.9'' \times 14.2''$ )

Weight 9.69 kg (21.4 lb)

### NVR

### Video

Video Compression Smart H.265, H.265, H.264

Frame Rate 25fps/30fps (PAL/NTSC)

Video Bit Rate 32Kbps-12Mbps

#### Video And Audio Input

IP Video Input 128 CH IPC Input

Two-Way Audio Input RCA ×1

#### Hard Disk

SATA SATA×16(RAID),eSATA×1

Capacity 8T

#### Network

Incoming Bandwidth 384Mbps or better

Outgoing Bandwidth 384Mbps or Better

Protocols TCP/IP, PPPoE, DHCP, DNS, DDNS, UPnP, NTP SMTP, ONVIF

Compatible Integration ONVIF

#### Video And Audio Output

Recording Resolution 12MP, 8MP, 6MP, 5MP, 4MP,3MP,1080P,960P,720P

Audio Output RCA ×1

Synchronous Playback Max 16 CH

#### External Interface

Network Interface RJ45 10/100/1000 Mbps × 2

Serial Interface RS485, connect to PTZ and keyboard

USB Interface USB2.0×2( front panel ), USB3.0×1( rear panel )

Alarm in 8

Alarm Out 4

### General

Power ATX

Power Consumption ≤15W(without HDD)

Working Humidity 10%~ 90% humidity

Working Environment -10~50 °C

Dimension 437×483×143 (W × D × H )

## K. LIGHT FIXTURE

### SCOPE:

- i. The scope of this section comprises of Supply, erection, testing and commissioning of lighting fixtures for internal lighting, wherever required, of the specified models.
- ii. Without restricting to the generality of the foregoing, this section shall include luminaries, lamps and accessories necessary and required for the installation.
- iii. Whether specifically mentioned or not, the luminaries and lamps shall be provided with all fixing devices, terminal blocks, holders etc. as required.
- iv. Bollard LED 3000K 110-270Vac 50-60Hz CRI > 80 Input power: 8W Height 800mm, Electronic driver ON/OFF CE and RoHS compliance TYPE: Bollard, IP rating IP66, impact resistance IK10. MATERIAL CHARACTERISTICS: Extruded aluminium bottom pipe Ø100 x H800mm with polycarbonate diffuser and integral base plate Ø180 with PG gland. Luminaire contains built in LED modules. Operating ambient temperature range is from -20°C to +40°C. Lumen output 300 lm, light source 96 power LEDs. Resistance to heat and fore for plastic part should be 850 degree celcius. Housing Color Dark grey RAL 7043. CCE, CE and RoHS compliance.
- v. 45W Led Street Light made up of pressure die cast aluminium housing with glass cover and unique road optics for better uniformity. The luminaire shall have minimum system lumen of 5400 lm and shall be with higher ingress protection IP66 and impact resistance of IK07. Operating voltage range: 120-270V/60Hz, Average life L70B50: 50000 hours. Lumen efficacy of LED >120 lm/W, CRI≥70, CCT-5700K, SDCM<5. Powered by built-in potted LED driver gives constant light over wide voltage range. Shall have HV cutoff@325V protection for 8hours. Surge protection 4 kV, power factor ≥0.95, THD≤ 10%.

- vi. Recessed mounted 2x2 LED panel ,made of CRCA housing with high efficiency PS Diffuser. LED Used shall be SMD type and fixture should have minimum efficacy at System level  $\geq 120$  lumens/watt with Minimum system Lumens 3600 & Max System wattage of 30W, Life of fixture : 50000 burning Hrs. @ L70B50 Lumen maintenance, CCT-6500K, (SDCM $\leq 5$ ), CRI Ra  $\geq 80$ , THD $< 10\%$ , PF  $> 0.95$ , an operating Voltage Range of 110 - 270 VAC. Minimum Internal Surge Protection 2.5KV..
- vii. LED Mirror batten light of 2ft length with a system wattage of 10-11W with a nominal system lumen output of 1100-1200 lumens and a minimum system efficacy of 110lm/W. CCT shall be 4000K and CRI  $\geq 80$ . Housing shall be extruded aluminium with powder coating & with IP20 protection. The luminaire shall meet IP20 rating with THD $\leq 20\%$  and PF  $\geq 0.90$ . an operating Voltage Range of 120 - 270 V AC. Minimum Internal Surge Protection 2.5KV
- viii. LED 4ft Linear with a nominal system lumen output of 2000 lumens and a minimum system efficacy of  $> 130$  lm/w @6500K. The luminaire shall have a rated system lifetime of 50,000 burning hours at L70. The luminaire should have a color temperature of 6500K and CRI $> 80$ ,SDCM $\leq 5$ . The luminaire shall meet IP20 rating with THD  $< 10\%$  and PF  $> 0.95$ .an operating Voltage Range of 120 - 270 V AC. The Luminaire should (Flicker Free Ripple  $< 5\%$  ), Hi-low cutoff circuit with auto restart feature & Minimum Internal Surge Protection 2.5KV. The luminaire housing should made of CRCA with a PC glossy diffuser.
- ix. LED Recess Down lighter ,made up of pressure die cast aluminum housing with high efficiency Prismatic PS diffuser, LED Used shall be SMD type and fixture should have minimum efficacy at System level  $\geq 100$  lumens/watt with Minimum system Lumens 1800 & max wattage 15W, Life of fixture : 50000 burning Hrs. @ L70B50 Lumen maintenance, CCT of 6500K (SDCM $\leq 5$ ), CRI Ra  $\geq 80$ , PF  $> 0.9$ , an Operating working temp range -  $0^{\circ}\text{C} < T_a < 45^{\circ}\text{C}$  & operating Voltage Range of 120-270 V AC. Minimum Internal Surge Protection 2.5KV..
- x. Recessed LED Down lighter ,made up of pressure die cast aluminum housing with high efficiency Prismatic PS diffuser, LED Used shall be SMD type and fixture should have minimum efficacy at System level  $\geq 100$  lumens/watt with Minimum system Lumens 1100 & max wattage 11W, Life of fixture : 50000 burning Hrs. @ L70B50 Lumen maintenance, CCT of 6500K (SDCM $\leq 5$ ), CRI Ra  $\geq 80$ , PF  $> 0.9$ , an Operating working temp range -  $0^{\circ}\text{C} < T_a < 45^{\circ}\text{C}$  & operating Voltage Range of 120-270 V AC. Minimum Internal Surge Protection 2.5KV.
- xi. LED indoor surface downlighter suitable for general lighting. Luminaire should have pressure die-cast Al housing with diffused optics. The luminaire should have CRI  $> 80$  and CCT of 6500K. The luminaire shall be compliant with IP20, IK02 classification. The fixture should have a minimum system efficacy of 110 lumen/Watt (suitable lux level should be mentioned as per guideline of location/area) and a minimum system lumen output of 2150 lumens and maximum system wattage of 18 Watts. The luminaire shall be designed so as to ensure lumen depreciation of up to 30% over 30k burning hours



@ design ambient temp 45 deg C. The electronic driver used shall have a power factor >0.95 , THD <10%. The fixture housing should be available in colors aluminium and grey. operating Voltage Range of 120-270 V AC. Minimum Internal Surge Protection 2.5KV.

- xii. Heavy duty bulkhead surface type lighting fixture 10W - 1100lm made up of pressure die-cast aluminium housing and Polyester Powder coated die cast aluminium with High quality polycarbonate diffuser in opal finish for glare free light distribution.
- xiii. 250 mm sweep decorative Fresh air fan with all accessories suitable for operation single phase 120-volt 60 cycle per second per sec. AC supply etc. as required. in the existing opening, including making the hole to suit the size of the above fan, making good the damage, connection, testing, commissioning earthing etc. as required.

#### ENERGY-SAVING FUNCTION

- i. Car ventilation, light
- ii. automatic shut off- If there is no calling or command signal within the stipulated time the car fan and lighting will be automatically closed in order to save energy.
- iii. Remote shut-off- The lift can be called to main landing (after finishing the service) through the Key switch and automatically exists the service.

**ANNEXURE-I**

**ELECTRICAL LOAD CALCULATION**

<b>Electrical Load Calculation</b>			
<b>S.NO.</b>	<b>DESCRIPTION</b>	<b>AREA (IN SQ.M)</b>	<b>Total load (KW)</b>
	<b>TOTAL BUILTUP AREA</b>	<b>2206</b>	
1	<b>Lighting, Power and Equipment Load</b>		124
2	HVAC Equipment Load		25
3	External Lighting & Facade Lighting		15
4	Water pumps		10
5	Firefighting Jockey pumps		30
6	Sign Boards		15
	<b>Total Connected Load (KW)</b>		<b>219</b>
	Total Connected Load In KVA @ 0.95 Power Factor		231
	Total demand Load in KVA, after considering diversity Factor @ 0.8		184
	<b>Dry Type Transformer, 1 No. 250 KVA at Loading Factor 0.8</b>		
	<b>DG Set for 100% backup, 1 nos. 250 KVA</b>		
	<b>UPS for Emergency Lighting Load, 1 No. 75 KVA</b>		

**ANNEXURE-II**

**MAKE /OEM LISTS: -**

<b>S. No</b>	<b>Equipment/Material</b>	<b>Approved Manufacturer Name</b>
1	LT Panels	ABB, L&T
2	TTA (Type Tested Assembly) Electrical Panels	Schneider ABB Siemens L&T Legrand
3	Active harmonic filter	Schneider Eaton Albex
4.	Air Circuit Breakers / Moulded Case Circuit Breaker / MPCB / Contactors	Siemens Schneider Electric L&T ABB Mitsubishi Legrand
5.	Automatic Transfer Switch (ATS)	ASCO VITZROTECH
6	Busduct & Rising Main	Schneider

		<p>Legrand</p> <p>L&amp;T</p> <p>Alfaduct</p>
7	Final Distribution Boards / MCB/RCCB	<p>Hager</p> <p>C&amp;S</p> <p>Indoasian</p> <p>Legrand</p> <p>Havells</p> <p>Siemens</p> <p>Schneider Electric</p> <p>ABB</p> <p>L&amp;T</p>
8	Control Transformer / Potential Transformers (Epoxy Cast Resin)	<p>Automatic Electric</p> <p>Gilbert &amp; Maxwell</p> <p>Precise</p> <p>Pragati</p> <p>Matrix</p> <p>Kappa</p>
9	Indicating Lamps LED type and Push Button	<p>Schneider Electric</p> <p>Siemens</p> <p>ESBEE</p> <p>Teknik</p> <p>Vaishno</p>

<b>S. No</b>	<b>Equipment/Material</b>	<b>Approved Manufacturer Name</b>
10	Digital Meters	Siemens Schneider Electric L&T Secure Nepune
11	LT Cables	Polycab KEI Finolex Rallison RR cables Grandlay Universal
12	Termination kits	3M Raychem M Seal
13	Cable Lugs / Glands	Dowells Comet Cosmos Braco Multi Electromac
14	PVC Insulated FRLS Wires	Polycab

		KEI Batra Henlay Finolex Grandlay Rallison RR Kabel
15	Terminal Blocks	Connect well Elmex Wago
16	Industrial Socket outlets	Neptune Balls Legrand Hager Schneider
17.	Cable Trays	Ricco Steelcraft RMCON SMC (Sai Metal Craft) MK Indeana Engg
18	Raceway	MK Honeywell OBO Betterman Legrand SMC RMCON
19.	Accessories for Supporting system	Hilti

		Fisher
20	Fire Sealant & Paints	3M Hilti Promat
<b>S. No</b>	<b>Equipment/Material</b>	<b>Approved Manufacturer Name</b>
21	Insulating Mats	DL Miller & Co. Premier Polyfilm Ltd RMG Polyvinyl India Ltd
22	Earthing	Erico Dehn Furse Obo Betterman L&T Cape Electric
23	Metal Conduit & Accessories	BEC AKG RMCON NIC
24	PVC Conduit & Accessories	BEC Polypack Precision
25	Switch & Sockets (Range as per approved sample only)	Legrand Schneider

		<p>Honeywell MK</p> <p>L&amp;T</p> <p>ABB</p> <p>Anchor</p> <p>Wipro (Northwest)</p> <p>Indoasian</p>
26	<p>LED Light Fixtures / Electronic Ballasts &amp; Accessories</p> <p>(Range as per approved sample only)</p>	<p>Philips</p> <p>Wipro</p> <p>OPPLE</p> <p>Regent</p>
27	Movement / Present Detector	<p>Hager</p> <p>Legrand</p> <p>Philips</p>
28	Ceiling Fan / Exhaust Fan	<p>Havells</p> <p>Crompton Greaves</p> <p>Rextron</p>
29	Busbar	Hindalco



**THE SCHEDULE OF INTERIORS (AREAS) TASKS AND ACTIVITIES WITH SPECIFICATION OF ILLUMINANCE, GLARE LIMITATION AND COLOUR QUALITY**

Type of interior, task or activity	$\overline{E}_m$ lux	$UGR_L$	$R_a$	Remarks
<b>1. General building areas</b>				
Entrance halls	100	22	60	
Lounges	200	22	80	
Circulation areas and corridors	100	28	40	At exits and entrances provide a transition zone and avoid sudden changes.
Stairs, escalators, travelators	150	25	40	
Loading ramps/bays	150	25	40	
Canteens	200	22	80	
Rest rooms	100	22	80	
Rooms for physical exercise	300	22	80	
Cloakrooms, washrooms, bathrooms, toilets	200	25	80	
Sick bay	500	19	80	
Rooms for medical attention	500	16	90	$T_{cp}$ at least 4000 K
Plant rooms, switch gear rooms	200	25	60	
Post room, switchboard	500	19	80	
Store, stockrooms, cold store	100	25	60	200 lux if continuously occupied
Dispatch packing handling areas	300	25	60	
Control station	150	22	60	200 lux if continuously occupied
<b>2. Agriculture building</b>				
Loading and operating of goods handling equipment and machinery	200	25	80	
Building for livestock	50	28	40	
Sick animal pens, calving stalls	200	25	80	
Feed preparation, dairy, utensil washing	200	25	80	
<b>3. Bakeries</b>				
Preparation and baking	300	22	80	
Finishing, glazing, decorating	500	22	80	
<b>4. Cement, concrete, &amp; bricks industry</b>				
Drying	50	28	20	Safety colours shall be recognisable.
Preparation of materials, work on kilns and mixers	200	28	40	
General machine work	300	25	80	For high-bay: see also clause 4.6.2.
Rough forms	300	25	80	For high-bay: see also clause 4.6.2.

*ISO 8995:2002(E)*

*CIE S 008/E-2001*

<b>5. Ceramics and glass industry</b>				
Drying	50	28	20	
Preparation, general machine work	300	25	80	For high-bay: see also clause 4.6.2.
Enamelling, rolling, pressing, shaping simple parts, glazing, glass blowing	300	25	80	For high-bay: see also clause 4.6.2.
Grinding, engraving, glass polishing, shaping precision parts, manufacture of glass instruments	750	19	80	For high-bay: see also clause 4.6.2.
Decorative work	500	19	80	
Grinding of optical glass, crystal hand grinding and engraving, work on average goods	750	16	80	
Precision work e.g decorative grinding, hand painting	1000	16	90	$T_{cp}$ at least 4000 K
Manufacture of synthetic precious stones	1500	16	90	$T_{cp}$ at least 4000 K
<b>6. Chemicals, plastics and rubber industry</b>				
Remote operated processing installations	50		20	Safety colours shall be recognisable.
Processing installations with limited manual intervention	150	28	40	
Constantly manned work places in processing installations	300	25	80	
Precision measuring rooms, laboratories	500	19	80	
Pharmaceutical production	500	22	80	
Tyre production	500	22	80	
Colour inspection	1000	16	90	$T_{cp}$ at least 6500 K
Cutting, finishing, inspection	750	19	80	

<b>7. Electrical industry</b>				
Cable and wire manufacture	300	25	80	For high-bay: see also clause 4.6.2.
Winding:				
- large coils	300	25	80	For high-bay: see also clause 4.6.2.
- medium-sized coils	500	22	80	For high-bay: see also clause 4.6.2.
- small coils	750	19	80	For high-bay: see also clause 4.6.2.
Coil impregnating	300	25	80	For high-bay: see also clause 4.6.2.
Galvanising	300	25	80	For high-bay: see also clause 4.6.2.
Assembly work:				
- rough e.g. large transformers	300	25	80	For high-bay: see also clause 4.6.2.
- medium e.g. switchboards	500	22	80	
- fine e.g. telephones	750	19	80	
- precision e.g. measuring equipm.	1000	16	80	
Electronic workshops, testing, adjusting	1500	16	80	

ISO 8995:2002(E)  
CIE S 008/E-2001

<b>8. Food industry</b>				
Workplaces and zones in breweries, malting floor, for washing, barrel filling, cleaning, sieving, peeling, cooking in preserve and chocolate factories, work places and zones in sugar factories, for drying and fermenting raw tobacco, fermentation cellar	200	25	80	
Sorting and washing of products, milling, mixing, packing	300	25	80	
Work places and zones in slaughter houses, butchers, dairies mills, on filtering floor, in sugar refineries	500	25	80	
Cutting and sorting of fruit and vegetables	300	25	80	
Manufacture of delicatessen foods, kitchen	500	22	80	
Manufacture work of cigars and cigarettes	500	22	80	
Inspection of glasses and bottles, product control, trimming, sorting decoration	500	22	80	
Laboratories	500	19	80	
Colour inspection	1000	16	90	$T_{cp}$ at least 4000 K
<b>9. Foundries and metal casting plants</b>				
Mansize underfloor tunnels, cellars etc.	50	28	20	Safety colours shall be recognisable.
Platforms	100	25	40	
Sand preparation	200	25	80	For high-bay: see also clause 4.6.2.
Dressing room	200	25	80	For high-bay: see also clause 4.6.2.
Workplaces at cupola and mixer	200	25	80	For high-bay: see also clause 4.6.2.
Casting bay	200	25	80	For high-bay: see also clause 4.6.2.
Shake out areas	200	25	80	For high-bay: see also clause 4.6.2.
Machine moulding	200	25	80	For high-bay: see also clause 4.6.2.
Hand and core moulding	300	25	80	For high-bay: see also clause 4.6.2.
Die casting	300	25	80	For high-bay: see also clause 4.6.2.
Model building	500	22	80	For high-bay: see also clause 4.6.2.

ISO 8995:2002(E)

CIE S 008/E-2001

<b>10. Hairdressers</b>				
Hairdressing	500	19	90	
<b>11. Jewellery manufacturing</b>				
Working with precious stones	1500	16	90	$T_{cp}$ at least 4000 K
Manufacture of jewellery	1000	16	90	
Watch making (manual)	1500	16	80	
Watch making (automatic)	500	19	80	
<b>12. Laundries and dry cleaning</b>				
Goods in, marking and sorting	300	25	80	
Washing and dry cleaning	300	25	80	
Ironing, pressing	300	25	80	
Inspection and repairs	750	19	80	
<b>13. Leather industry</b>				
Work on vats, barrels, pits	200	25	40	
Fleshing, skiving, rubbing, tumbling of skins	300	25	80	
Saddlery work, shoe manufacture stitching, sewing, polishing, shaping, cutting, punching	500	22	80	
Sorting	500	22	90	$T_{cp}$ at least 4000 K
Leather dyeing (machine)	500	22	80	
Quality control	1000	19	80	
Colour inspection	1000	16	90	$T_{cp}$ at least 4000 K
Shoe making	500	22	80	
Glove making	500	22	80	

ISO 8995:2002(E)

CIE S 008/E-2001

<b>14. Metal working and processing</b>				
Open die forging	200	25	60	
Drop forging, welding, cold forming	300	25	60	
Rough and average machining: tolerances > 0,1 mm	300	22	60	
Precision machining: grinding: tolerances < 0,1 mm	500	19	60	
Scribing; inspection	750	19	60	
Wire & pipe drawing shapes	300	25	60	
Plate machining ≥5mm	200	25	60	
Sheet metalwork <5mm	300	22	60	
Tool making; cutting equipment manufacture	750	19	60	
<b>Assembly:</b>				
- rough	200	25	80	For high-bay: see also clause 4.6.2.
- medium	300	25	80	For high-bay: see also clause 4.6.2.
- fine	500	22	80	For high-bay: see also clause 4.6.2.
- precision	750	19	80	For high-bay: see also clause 4.6.2.
Galvanising	300	25	80	For high-bay: see also clause 4.6.2.
Surface preparation and painting	750	25	80	
Tool, template and jig making, precision mechanics, micro- mechanics	1000	19	80	
<b>15. Paper industry</b>				
Pulp mills, edge runners	200	25	80	For high-bay: see also clause 4.6.2.
Paper manufacture and processing, paper and corrugating machines, cardboard manufacture	300	25	80	For high-bay: see also clause 4.6.2.
Standard book binding work, e.g. folding, sorting, gluing, cutting, embossing, sewing	500	22	60	
<b>16. Power stations</b>				
Fuel supply plant	50	28	20	Safety colours shall be recognisable.
Boiler house	100	28	40	
Machine halls	200	25	80	For high-bay: see also clause 4.6.2.
Auxiliary rooms, e.g pump rooms, condenser rooms, switchboard, etc.	200	25	60	
Control rooms	500	16	80	1. Control panels are often vertical. 2. Dimming may be required. 3. For VDT work see clause 4.10.
<b>17. Printers</b>				
Cutting, gilding, embossing, block engraving, work on stones and platens, printing machines, matrix making	500	19	80	
Paper sorting and hand printing	500	19	80	
Type setting, retouching, lithography	1000	19	80	
Colour inspection in multi-coloured printing	1500	16	90	$T_{cp}$ 5000 K
Steel and copper engraving	2000	16	80	For directional light see clause 4.5.2.

ISO 8995:2002(E)  
CIE S 008/E-2001

<b>18. Iron and steel works</b>				
Production plants without manual Intervention	50	28	20	Safety colours shall be recognisable.
Production plants with occasional manual operation	150	28	40	
Production plants with continuous manual operation	200	25	80	For high-bay: see also clause 4.6.2.
Slab store	50	28	20	Safety colours shall be recognisable.
Furnaces	200	25	20	Safety colours shall be recognisable.
Mill train, coiler, shear line	300	25	40	
Control platforms, control panels	300	22	80	
Test, measurement and inspection	500	22	80	
Underfloor man sized tunnels belt sections, cellars etc.	50	28	20	Safety colours shall be recognisable.
<b>19. Textile industry</b>				
Workplace and zones in baths, bale opening	200	25	60	
Carding, washing, ironing, drawing, combing, sizing, card cutting, pre-spinning, jute and hemp spinning	300	22	80	
Spinning, plying, reeling, winding warping, weaving, braiding, knitting	500	22	80	Prevent stroboscopic effects.
Sewing, fine knitting, taking up stitches	750	22	90	
Manual design, drawing patterns	750	22	90	$T_{cp}$ at least 4000 K
Finishing, dyeing	500	22	80	
Drying room	100	28	60	
Automatic fabric printing	500	25	80	
Burling, picking, trimming	1000	19	80	
Colour inspection, fabric control	1000	16	90	$T_{cp}$ at least 4000 K
Invisible mending	1500	19	90	$T_{cp}$ at least 4000 K

ISO 8995:2002(E)  
CIE S 008/E-2001

Hat manufacturing	500	22	80	
<b>20. Vehicle construction</b>				
Body work and assembly	500	22	80	
Painting, spraying chamber, polishing chamber	750	22	80	
Painting: touch-up, inspection	1000	16	90	$T_{cp}$ at least 4000 K
Upholstery manufacture (manned)	1000	19	80	
Final inspection	1000	19	80	
<b>21. Wood working &amp; furniture industry</b>				
Automatic processing e.g. drying plywood manufacturing	50	28	40	
Steam pits	150	28	40	
Saw frame	300	25	60	Prevent stroboscopic effects.
Work at joiner's bench, gluing, assembly	300	25	80	
Polishing, painting, fancy joinery	750	22	80	
Work on wood working machines e.g. turning, fluting, dressing, rebating, grooving, cutting, sawing, sinking	500	19	80	Prevent stroboscopic effects.
Selection of veneer woods, maquetry, inlay work	750	22	90	$T_{cp}$ at least 4000 K
Quality control	1000	19	90	$T_{cp}$ at least 4000 K
<b>22. Offices</b>				
Filing, copying, circulation, etc.	300	19	80	
Writing, typing, reading, data processing	500	19	80	For VDT-work see clause 4.10.
Technical drawing	750	16	80	
CAD workstation	500	19	80	For VDT-work see clause 4.10.
Conference and meeting rooms	500	19	80	Lighting should be controllable.
Reception desk	300	22	80	
Archives	200	25	80	
<b>23. Retailing</b>				
Sales area small	300	22	80	
Sales area large	500	22	80	
Till area	500	19	80	
Wrapper table	500	19	80	
<b>24. Restaurants and hotels</b>				
Reception/cashier desk, porters desk	300	22	80	
Kitchen	500	22	80	
Restaurant, dining room, function room	200	22	80	The lighting should be designed to create intimate atmosphere.
Self-service restaurant	200	22	80	
Buffet	300	22	80	
Conference rooms	500	19	80	Lighting should be controllable.
Corridors	100	25	80	During night time lower levels are acceptable.
<b>25. Places of entertainment</b>				
Theatres & concert halls	200	22	80	
Multi purpose halls	300	22	80	

Practice rooms, dressing rooms	300	22	80	Glare free mirror lighting for make-up required.
Museums (general)	300	19	80	Lighting to suit the display requirements, protect against radiation effects. See Museum Lighting Guide.
<b>26. Libraries</b>				
Bookshelves	200	19	80	
Reading area	500	19	80	
Counters	500	19	80	
<b>27. Public car parks (indoor)</b>				
In/out ramps (during the day)	300	25	40	Safety colours shall be recognisable.
In/out ramps (at night)	75	25	40	Safety colours shall be recognisable.
Traffic lanes	75	25	40	Safety colours shall be recognisable.
Parking areas	75	28	40	A high vertical illuminance increases recognition of peoples faces and therefore the feeling of safety.
Ticket office	300	19	80	1. Avoid reflections in the windows. 2. Prevent glare from outside.
<b>28. Educational buildings</b>				
Play school room	300	19	80	
Nursery class	300	19	80	
Nursery craft room	300	19	80	
Classrooms, tutorial rooms	300	19	80	Lighting should be controllable.
Classroom for evening classes and adults education	500	19	80	
Lecture hall	500	19	80	Lighting should be controllable.
Black board	500	19	80	Prevent specular reflections.
Demonstration table	500	19	80	In lecture halls 750 lux
Art and craft rooms	500	19	80	
Art rooms in art schools	750	19	90	$T_{cp} > 5000K$
Technical drawing rooms	750	16	80	
Practical rooms and laboratories	500	19	80	
Teaching workshop	500	19	80	
Music practice rooms	300	19	80	
Computer practice rooms	500	19	80	For VDT-work see clause 4.10.
Language laboratory	300	19	80	
Preparation rooms and workshops	500	22	80	
Student common rooms and assembly halls	200	22	80	
Teachers rooms	300	22	80	
Sports halls, gymnasiums and swimming pools	300	22	80	For public access facilities see CIE 58 - 1983 and CIE 62 - 1984.

ISO 8995:2002(E)  
CIE S 008/E-2001



<b>29. Health care premises</b>				
Waiting rooms	200	22	80	Illuminance at floor level
Corridors: during the day	200	22	80	Illuminance at floor level
Corridors: during the night	50	22	80	Illuminance at floor level
Day rooms	200	22	80	Illuminance at floor level
Staff office	500	19	80	
Staff rooms	300	19	80	
<b>Wards</b>				
- General lighting	100	19	80	Illuminance at floor level
- Reading lighting	300	19	80	
- Simple examination	300	19	80	
Examination and treatment	1000	19	90	
Night lighting, observation lighting	5	19	80	
Bathrooms and toilets for patients	200	22	80	
Examination room general	500	19	90	
Ear and eye examination	1000		90	Local examination luminaire
Reading and colour vision test with vision charts	500	16	90	
Scanners with image enhancers and television systems	50	19	80	For VDT work see clause 4.10.
Dialysis rooms	500	19	80	
Dermatology rooms	500	19	90	
Endoscopy rooms	300	19	80	
Plaster rooms	500	19	80	
Medical baths	300	19	80	
Massage and radiotherapy	300	19	80	
Pre-op and recovery rooms	500	19	90	
Operating theatre	1000	19	90	
Operating cavity	Special			$\bar{E}_m = 10000 \text{ lux} - 100000 \text{ lux}$
<b>Intensive care</b>				
- General lighting	100	19	90	At floor level
- Simple examinations	300	19	90	At bed level
- Examination and treatment	1000	19	90	At bed level
- Night watch	20	19	90	
<b>Dentists</b>				
- General lighting	500	19	90	Lighting should be glare free for the patient.
- At the patient	1000		90	Local examination luminaire
- Operating cavity	5000		90	Values higher than 5000 lux may be required.

ISO 8995:2002(E)

CIE S 008/E-2001

- White teeth matching	5000		90	$T_{cp} > 6000$ K
Colour inspection (laboratories)	1000	19	90	$T_{cp} \geq 5000$ K
Sterilisation rooms	300	22	80	
Disinfection rooms	300	22	80	
Autopsy rooms and mortuaries	500	19	90	
Autopsy table and dissecting table	5000		90	Values higher than 5000 lux may be required.
<b>30. Airports</b>				
Arrival and departure halls, baggage claim areas	200	22	80	For high-bay: see also clause 4.6.2.
Connecting areas, escalators, travelators	150	22	80	
Information desks, check-in desks	500	19	80	For VDT work see clause 4.10.
Customs and passport control desks	500	19	80	Vertical illuminance is important.
Waiting areas	200	22	80	
Luggage store rooms	200	28	60	
Security check areas	300	19	80	For VDT-work see clause 4.10.
Air traffic control tower	500	16	80	1. Lighting should be dimmable. 2. For VDT work see clause 4.10. 3. Glare from daylight should be avoided.
Air traffic rooms	500	16	80	1. Lighting should be dimmable. 2. For VDT work see clause 4.10.
Testing and repair hangars	500	22	80	For high-bay: see also clause 4.6.2.
Engine test areas	500	22	80	For high-bay: see also clause 4.6.2.
Measuring areas in hangars	500	22	80	For high-bay: see also clause 4.6.2.
Platforms and passenger subways (underpasses)	50	28	40	
Ticket hall and concourse	200	28	40	
Ticket and luggage offices and counters	300	19	80	
Waiting rooms	200	22	80	
<b>31. Churches, mosques, synagogues and temples</b>				
Body of church	100	25	80	
Chair, altar, pulpit	300	22	80	

ISO 8995:2002(E)

CIE S 008/E-2001

**NOTE:** All the codes and compliances irrespective of what is mention, shall be the codes and compliances as applicable in Osaka, Japan.

**Makes:** If the makes of the material mentioned herein are not available then the contractor may propose the equivalent product of the “make”/manufacturers which is available in Japan fulfilling the local laws and compliances suitable the functions for which is meant and decisions of Engineer in Charge/ ITPO shall be final.

**Note:** The Code given are indicative however the contractor before procuring & executing the work shall ascertain & determine the applicable Japanese codes, which are required to be complied with Osaka Japan, and only there after the respective material should be used.

## TECHNICAL specifications (HVAC)

### 7 Chapter G

#### 7.1 Air Handling Units (Double Skin) (Sectional Type)

##### 1. General:

The air handling units shall be of as per drawing and complete in all respects and shall generally comply with the specifications as given in the following paragraphs.

##### 2. Air Handling Units

The air handling units shall be double skin sectional, draw through type. It shall include suitable filter section, coil section, fan and motor section in suitable horizontal configuration and also mixing box (if specified).

##### 3. Fan Assembly & Accessories

- 3.1 Fans shall be backward curved plug fan with aero foil design blades so as to give maximum efficiency for given duty condition. The entire fan with casing will be certified by a reputed, internationally acclaimed certifying body which will be a 3rd party like Eurovent or ARI or AMCA and the entire Fan + Motor assembly will be balanced at supplier's works before dispatch. Fans driven by variable frequency drive shall be backward inclined irrespective of static pressure value. Fans shall be selected for minimum efficiency of 70%. Fan array with multiple fans shall be used for capacities more than 15000 CMH. Plug fan in fan array shall have individual VFDs for every motor fan set. Fan motor assembly shall be statically and dynamically balanced as per relevant ISO/AMCA/EUROVENT standard. Certified computerized selection for AHU shall be with fan selection.

Motors shall be mounted inside the AHU casing on slide rails for alignment and be totally enclosed, fan cooled with class 'F' insulation.

Both fan and motor assemblies shall be mounted on powder coated MS/galvanized steel (depending on size) base frame.

Heavy duty anti-vibration mounts shall be provided for isolating the unit casing. Flame retardant, waterproof silicone rubber impregnated flexible connection shall be provided at the fan discharge.

4. Cooling/Heating coil

Chilled water coils shall have 12.5 to 15 mm dia (O.D) tubes minimum 0.41 mm thick with sine wave aluminium fins firmly bonded to copper tubes assembled in zinc coated steel frame. Face and surface areas shall be such as to ensure rated capacity from each unit and such that the air velocity across the coil shall not exceed 150 meters per minute. The coil shall be pitched in the unit casing for proper drainage. The coil shall have suitable size header with chilled water supply & return connections protruding out of AHU casing by minimum 150 mm. Each coil shall be factory-tested at 21 kg per sq. m air pressure under water. Tube shall be mechanically expanded for minimum thermal contact resistance with fins. Fin spacing shall be 4 - 5 fins per cm. Water pressure drop in coil shall not exceed 10 PSIG.

All public area AHUs shall be provided with minimum 6 Row Cooling Coil. All TFA AHU's shall be provided with minimum 8 row cooling coil. Reheat coil may be provided if indicated in Schedule of Quantities.

**7.2 Coil performance shall be certified by a third party like Eurovent/AHRI.**

5. Filter

Each unit shall be provided with a factory assembled filter section containing washable synthetic type air filters having GI frame. Filter media and frame shall be rust proof and corrosion resistant. The filter shall have minimum 90% efficiency down to 10 microns. The media shall be supported with HDP mesh on one side and aluminium mesh on other side. Filter banks shall be easily accessible and designed for easy withdrawal and renewal of filter cells. Filter framework shall be fully sealed and constructed from galvanized steel. For green buildings, AHUs shall also be provided with MERV-13 filters, if the project is opting for credit EQ-5. Filter by pass rating shall be of grade F9 as per EN standards.

6. Drain pan

- 6.1 The drain pan shall be sandwiched type with S.S. sheets on top and GI sheet on the bottom complete with PUF injected tray.
- 6.2 The drain pan shall be a minimum of 25 mm deep. Drain outlet shall be of S.S. and of 25 mm dia.

7. Coil and filter Section

The cooling coils, special and standard filters, etc., shall all be housed in a separate section of suitable size and length. The inspection doors, shall have double synthetic rubber seals doors and locking arrangements. The gaps between filter frames and housing shall have synthetic rubber packing, to eliminate any air leakage. All filter frame shall be epoxy painted. The flat filter section shall be suitable for mounting filters vertically.

8. AHU Enclosure/Section

- 8.1 The AHU enclosure shall be double skin design with the main frame work made of extruded aluminium structural sections.
- 8.2 The panels shall be double sandwich type with 0.60 mm pre-coated galvanized sheet on the outside and .60mm galvanized sheet on the inside. The insulation shall be 25 mm thick foam injected polyurethane foam. The opening for access doors shall be provided with the neoprene rubber T-gaskets fixed in grooves in the extruded sections.
- 8.3 The sandwich panels shall be fixed to the frame work with self-tapping stainless-steel screws and both ends of the screw shall be provided with rubber caps.
- 8.4 The access door to fan section shall be fitted with a microswitch & light to shut-off the fan & switch on the light.

9. Fan Motor & Starter

- 9.1 The fan motor shall be totally enclosed fan cooled conforming to EFF-1 high efficiency as per I.S. 12615- 2004 (Rev.I) and tolerance as per I.S. 325-1996 and conforming to specifications in Control panel, motors & switchgear section.
- 9.2 The starter shall either be DOL or star delta type to suit the motor rating and conforming to specification under control panel, motor & switchgears.

*10. Automatic Controls (To suit single pumping system)*

- 10.1 The AHU unit shall have motorized modulating 3 way mixing valve selected with pressure drop thin 10 to 15% of the coil pressure drop.
- 10.2 A suitable modulating electronic thermostat shall be provision (unless the system has provided BMS for AHUs).

*11. Automatic Controls (To suit multiple pumping system)*

- 11.1 The AHU unit shall be provided automatic dynamic control cum balancing 2 way valve with facility to adjust and set the max. flow at the required limit.
- 11.2 A suitable modulating electronic thermostat shall be provided to the control the above valve (unless the system has provision for BMS for the AHUs).

*12. Fresh air controls*

An adjustable damper of G.I. sheet along with bird screen, air inlet louvers and air filters shall be provided in the wall of AHU room, for fresh air entry. (As part of AHU price)

*13. Accessories*

- 13.1 Each air handling unit shall be complete with the following as part of AHU price.
  - 13.1.1 Flexible connection between the fan outlet and duct.
  - 13.1.2 Vibration isolators of 90% efficiency.
  - 13.1.3 Each unit shall have the following items (Priced Separately).
  - 13.1.4 Stem type thermometers at coil inlet and outlet, with tubing and gauge cocks.

- 13.1.5 Pressure gauge of suitable range with cock at inlet and outlet of the coil, with tubing and gauge cocks.
- 13.1.6 Butterfly Valve at inlet and balancing valve at outlet (with 2 or 3 way motorized control valve).
- 13.1.7 Butterfly valves at inlet and outlet of the coil (with Dynamic Balancing cum control valve).
- 13.1.8 Drain line from the unit up to floor trap.

#### 14. Testing

The air handling unit shall be tested to measure air quantity and coil performance by measuring temperature difference, water flow rate using balancing valve and then calculating the capacity.

#### 15. Limitations

- 15.1 The air velocity across the cooling coil shall not exceed 550 F.P.M. (2.79 m per sec.).
- 15.2 The fan outlet velocity shall not exceed 2000 FPM. (10.17 m/sec.) subject to Fan Noise Level not exceeding 75 dba.
- 15.3 The air velocity across the filters shall not exceed 500 FPM (2.5 m/sec.)

#### 16. Insulation

The panels of Double Skin AHU'S shall be sandwiched with 25 mm thick polyurethane foam insulation of 40 kg. /cm<sup>3</sup>. density having a K value of 0.014 Kcal/mhr oC.

### 7.3 Air Handling Units (Double Skin) (Ceiling Suspended Type)

#### 1. Scope

The scope of this section, comprises the supply, erection, testing and commissioning of double skin construction air handling units, conforming to these Specifications and in accordance with requirements of drawings and of the Schedule of Quantities.

2. **Type**

The air handling units shall be double skin construction, draw-thru type comprising of various sections, filter section, coil section and fan section, mixing box, (wherever the return air and fresh air are ducted) as shown on drawings and included in schedule of quantities.

3. **Capacity**

The air handling capacities, maximum motor horse power and static pressure shall be as shown on Drawings and in Schedule of Quantities.

4. **Casing**

Double skinned panels shall be 40+/-2 mm thick Double Skin Panels with thermal break profile, shall be made of 0.6mm Pre-coated GSS on outside and 0.6mm Galvanized sheet inside with 275 GSM galvanized coating for corrosion resistance and with CFC – FREE P.U. insulation of 42 (+/- 5%) kg/Cu M injected in between with an internal gasket between the skins to interrupt the thermal bridge of the panel. Outer sheet of panels shall be made of galvanized pre-coated sheet of 0.6 mm thickness to ensure mechanical strength as per class D1 of EN 1886, air leakage as per class L1 of EN 1886, thermal bridging of minimum TB2 class and thermal transmittance of minimum T2 class as per EN 1886 tested and certified by Eurovent authorized lab.

The entire framework shall be mounted on an aluminium alloy or galvanized steel or heavy duty engineering composite material (depending on size) channel base as per manufacturer's recommendation. Panels shall be assembled together to form an enclosure that is capable of low air leakage potential, conforming to class A of EN 1886:2007. Handles shall be made of hard nylon and all access panels should be openable with Allen key arrangement. Units supplied with various sections shall be suitable for on site assembly with continuous foam gasket. All fixing and gaskets shall be concealed. All access door must have EPDM grooved type gaskets of minimum 10mm thickness.



Units shall have hinged or removable type quick opening access door in the fan section and also in filter section where filters are not accessible from outside. Access doors shall be double skin type. All the section of air handling units should be accessible for easy maintenance.

Condensate drain pan shall be fabricated from minimum 20 gauge stainless steel sheet with all corners welded.

5. **Mixing Box**

AHU's requiring mixing boxes as specified in Schedule of Quantities shall be complete with fresh and return air dampers.

6. **Thermal break AHU**

AHU's such as TFA units, AHU with mixing box having return air ducted shall be provided with thermal break casing as indicated in schedule of quantities. Also these AHU's shall be provided with 40 +/- 2 mm thick panel. In case of AHU casing design with no contact between inner and outer surface, thermal break can be avoided.

7. **Damper**

Dampers shall be opposed blade type. Blades shall be made of double skinned aero foil aluminium sections with integral gasket and assembled within a rigid extruded aluminium alloy frame. All linkages and supporting spindles shall be made of aluminium or nylon, turning in teflon bushes. Manual dampers shall be provided with a Bakelite knob for locking the damper blades in position. Linkages shall be extended wherever specified for motorized operation. Damper frames shall be sectionalized to minimize blade warping. Air leakage through dampers when in the closed position shall not exceed 1.5% of the maximum design air volume flow rate at the maximum design air total pressure.

8. **Motor and Drive**

Fan motors shall be energy efficient and shall be 415±10% volts, 50 cycles, three phases, totally enclosed fan-cooled class F, with IP-55 protection. Motors shall be especially designed for quiet. Drive to fan shall be provided through belt-drive/ Direct drive arrangement. Belts shall be of the oil-resistant type. to maintain class of cleanness, for three stage filtration AHUs, belt drive shall not be used and direct driven plug fans shall be used. Frequency converter (VFD) for energy saving, shall be supplied by the AHU manufacturer for all AHUs with direct driven fans.

9. **Fan**

Fans shall be backward curved Plenum plug fan with aero foil design blades so as to give maximum efficiency for given duty condition. In case of Plug fan, the entire fan with casing will be certified by a reputed 3rd party internationally acclaimed certifying body like Eurovent/ AMCA, and the entire Fan + Motor assembly will be balanced at supplier's works before dispatch. Fans driven by variable frequency drive shall be backward inclined irrespective of static pressure value. Fans shall be selected for minimum efficiency of 70%. Fan wheels shall be made of MS epoxy

coated/composite material in case of plug fans. Fan array with multiple fans should be used for capacities more than 15000 CMH. Plug fans in fan array shall have individual VFDs for every motor fan set. Certified Computerized selection for AHU shall be with fan selection and sound level spectrum. Complete AHU sound level should be given in computerized selection sheet instead of sound level of bare fan.

Motors shall be mounted inside the AHU casing on rigid frame/ slide rails for alignment, and be totally enclosed, fan cooled, to be class 'F' insulation.

Heavy duty anti-vibration mounts shall be provided for isolating the unit casing. Fire retardant, waterproof silicone rubber impregnated flexible connection shall be provided at the fan inlet/ discharge.

10. **Cooling Coils**

Chilled water coils shall have 12.5 to 15 mm dia (O.D) tubes minimum 0.35 mm thick with sine wave aluminium fins firmly bonded to copper tubes assembled in zinc coated steel frame. Face and surface areas shall be such as to ensure rated capacity from each unit and such that the air velocity across the coil shall be around 150 meters per minute. Where, air velocity of coil is more than 170 meter per minutes, additional PVC eliminator should be provided to avoid water carryover. The coil shall be pitched in the unit casing for proper drainage. The coil shall have MS/copper header with chilled water supply & return connections protruding out of AHU casing by minimum 150 mm and fitted with MS stub for copper head for connection with MS pipe. Each coil shall be factory-tested at 21 kg per sq. m air pressure under water. Tubes shall be mechanically expanded for minimum thermal contact resistance with fins. Fin spacing shall be 4 - 5 fins per cm. Water pressure drop in coil shall not exceed 10 PSIG.

All public area AHUs shall be provided with minimum 6 Row Cooling Coil. All TFA AHU's shall be provided with minimum 8 row cooling coil. Reheat coil may be provided if indicated in Schedule of Quantities.

Certified Computerized selection for AHU shall be with coil selection.

11. **Filters**

Each unit shall be provided with a factory assembled filter section containing washable synthetic type air filters having GI frame. Filter media and frame shall be rust proof and corrosion resistant. The filter shall have

minimum 90% efficiency down to 10 microns. The media shall be supported with HDP mesh on one side and aluminum mesh on other side. Filter banks shall be easily accessible and designed for easy withdrawal and renewal of filter cells. Filter framework shall be fully sealed and constructed from GI/aluminum alloy. For green buildings, AHUs shall also be provided with MERV-13 filters, if the project is opting for credit EQ-5. Filter by pass rating shall ensure F9 standard. Certified Computerized selection for AHU shall be with filter selection.

12. **Accessories**

Each air handling unit shall be provided with manual air vent at high point in the cooling coil and drain plug in the bottom of the coil. In addition, the following accessories may be required at air handling units, their detailed specifications are given in individual sections, & quantities separately identified in schedule of Quantities.

- a. Insulated butterfly valves, balancing valves, 'Y' strainer, union & condensate drain piping with 'U' trap up to sump or floor drain in air handling unit room, as described in section "Piping".
- b. Thermometers in the thermometer wells & pressure gauge (with cocks) within gauge ports in chilled water supply and return lines as per the section "Instruments".
- c. Water resistance marine light with power cabling.

13. **Fresh air intakes**

Extruded aluminium construction duly anodized (20 microns and above) fresh air louvers with bird screen and dampers shall be provided in the clear openings in masonry walls of the air handling unit rooms having at least one external wall. Louvers, damper, pre-filters, ducts and fresh air fan with speed regulator shall be provided as shown on Drawings and in Schedule of Quantities. Fresh air interlocking, opposed-blade louver type. Blades shall be made of extruded aluminum construction and shall be rattle-free. Dampers shall be similar to those specified in "Air Distribution". Fresh air fans and fresh air intakes shall be as per the requirements of Schedule of Quantities. Fresh air dampers shall be of the interlocking, opposed-blade louver type. Blades shall be made of extruded aluminum construction and shall be rattle-free. Dampers shall be similar to those specified in "Air Distribution". Fresh air fans and fresh air intakes shall be as per the requirements of Schedule of Quantities.

14. **Painting**

Shop coats of paint that have become marred during shipment or erection shall be cleaned off with mineral spirits, wire brushed and spot primed over the affected areas, then coated with paint to match the finish over the adjoining shop painted surface.

15. **Performance Data**

Air handling unit shall be selected for the lowest operating noise level of the equipment. Fan performance rating and power consumption data, with operating points clearly indicated shall be submitted and verified at the time of testing and commissioning of the installation. Computerized selection for air handling units shall be provided through 3rd party certified software for all the FMUs.

16. **Testing**

Cooling capacity of various air handling unit models be computed from the measurements of air flow and dry and wet bulb temperatures of air entering and leaving the coil. Flow measurements shall be by an anemometer and temperature measurements by accurately calibrated mercury-in-glass thermometers. Computed results shall conform to the specified capacities and quoted ratings. Power consumption shall be computed from measurements of incoming voltage and input current.

17. **Limitations**

17.1 The air velocity across the cooling coil shall not exceed 550 F.P.M. (2.79 M per sec.).

17.2 The fan outlet velocity shall not exceed 2000 FPM. (10.17 M/Sec.) subject to Fan Noise Level not exceeding 75 dBA.

17.3 The air velocity across the filters shall not exceed 500 FPM (2.5 M per sec.)

## 7.4 Fan Coil Units

1. **General**

The fan coil units shall be complete in all respects and shall generally comply with the specifications as given hereunder.

2. Fan Coil Units

2.1 The fan coil units shall be ceiling suspended horizontal /vertical type complete with finned coil, fan section with motor, drain pans, air filters, filter box, fan speed regulator and other controls.

2.2 Cooling Coil

The coil shall be of seamless copper tubes not less than 9 mm O.D. 0.41 mm thick and shall have continuous aluminium plate fins. The fins shall be spaced by collars forming integral part of the fins. The tubes shall be staggered in the direction of air flow. The coil circuit should be sized for adequate water velocity but not exceeding 1.8 M/s (6 F.P.S) the air velocity across coil shall not exceed 500 FPM or 155 MPM the fins shall be uniformly bonded to the tubes by hydraulic expansion of the tubes.

The coils shall be tested against leaks at a hydraulic pressure of 10 kg/sq.cm. This pressure shall be maintained for a period of 2 hours. No drop should be observed indicating any leaks.

2.3 Fan Section

2.3.1 This shall consist of (2) two lightweight aluminium impellers of forward curved type, both statically and dynamically balanced, along with properly designed G.I. sheet casings.

2.3.2 The two impellers shall be directly mounted on to a double shaft, single phase multiple winding motor capable of running at (3) three speeds.

2.3.3 A. G.I. acoustically lined Plenum shall connect the fan outlets to the coil.

2.4 Drain pans

2.4.1 The drain pan shall be of double skin construction made of 1.25 mm (16 GA.) G.I. Sheet, steel, covering the whole of coil section and extended on one side for accommodating coil connection, valve etc and complete with a 25 mm drain connection. The drain pan shall be insulated with 25 mm expanded polystyrene and covered with second G.I. tray.

2.5 Filter Plenum (Horizontal Type)

2.5.1 The Plenum shall be part of unit ceiling housing the fans and the coils.

2.5.2 Each unit will have a 12 MM thick air Filter made of Nylon mesh filter media in an aluminium frame.

3. FCU casing

The Vertical type fan coil units will be provided with plastic cover with a steel casing to house the coil, filter and have space for piping & controls.

4. Speed Control

A sturdy switch shall be provided with the unit complete with wiring, for off and with minimum (3) three speed control, of the fan.

5. Painting

The fan coil units should be powder coated in suitable colors.

6. Automatic Controls

6.1 Each unit shall have a room type thermostat and a 2 way motorized water valve. The valve shall be fixed at a convenient location. The thermostat shall be mounted along with the speed control switch on a common plate. The plate shall clearly indicate the fan positions. The controls should be as per specifications under 'controls'. (Priced Separately).

6.2 The water valves on inlet line shall be of gun metal ball type with integral water strainers, having BSP(FPT) inlet and flare type mpt outlet connection. The valve on return line shall be as above, but without the water strainer. (As part of unit price).

7. Water Connections

The water lines shall be finally connected to the coil of the fan coil unit, by at least 300 mm long, type I seamless solid drawn copper tubing with flare fittings and connections. (as part of FCU price)

## 7.5 Air Filters

1. General

1.1 The various types of filters to be used in the different systems to achieve the required degree of air purification and the HEPA filter holder, shall conform to the following specifications :

2. HEPA (Absolute) Filters

2.1 The point to point scanned and Di-Octyl Phthalate (D.O.P) tested flange type HEPA filters shall have an efficiency of 99.99% for a particle size of 0.3 microns. Flange width not to exceed 20 mm.

- 2.2 Each filter shall be sealed from all sides in aluminium filter frame and joints sealed with ductile epoxy resin, having impact strength 2.5-4.0 kg/cm<sup>2</sup> & modulus of elasticity strength 750-780 kg/cm<sup>2</sup>.
- 2.3 The filtering media shall be of micro fiber glass paper to provide the required filtering efficiency.
- 2.4 Each filter shall carry a test report from suitable agency, certifying the efficiency of the filter according to D.O.P test.
- 2.5 The initial pressure drop (IPD) should be less than 15 MM WG at rated CFM. Supplier shall indicate the pressure drop in choked condition.

3. High Efficiency Filters (Microvee Filters)

- 3.1 Microvee filters in flange type construction shall be made out of polyester/polypropylene media shall have an efficiency greater than 98% down to 5 micron or less particle size according to D.O.P. Test method.
- 3.2 The filter element shall be housed in aluminium anodized frame. Media shall be supported on one side with HDPE mesh & another side with aluminium mesh.
- 3.3 The media and HDPE shall be stitched together. Edge of the filter shall be duly protected with polyester beading. Number of folds shall be 11 folds/RFT., across actual face area of the frame.
- 3.4 The initial pressure drop shall be in between 6.5-8.5 MM WG and it should not exceed 20 MM WG.
- 3.5 The filters should be cleanable and washable.
- 3.6 The filter element should be properly sealed with frame with the help of epoxy so that there is absolutely no air bypass after Nos. of washes. Foam between folds & frame shall not be used.
- 3.7 Minimum 3 No. Aluminium anodized combs shall be inserted for keeping the Plates separated from each other.

4. Pre Filters

- 4.1 The pre filter in box type construction shall have an efficiency of 90% down to 10 microns.
- 4.2 The frames shall be made out of aluminium anodized extruded sections.
- 4.3 The filtering media shall be polyester/polypropylene.



- 4.4 The frame shall be properly sealed so that there is absolutely no air by-pass.
- 4.5 No. of folds 11 folds/ft. of face area.
- 4.6 Pre-filters for return air through return air risers shall be provided with perforated aluminium anodized sheet having 70% perforation. Supplier to furnish mounting details.

5. Filter Mounts

- 5.1 The various types of filters shall be mounted in suitable holding frame sized to suit the filter selection.
- 5.2 The frame shall be of Aluminium sheet of suitable thickness formed to make a rigid mounting structure.
- 5.3 Synthetic rubber gaskets shall be provided to make the frame leak proof and far sealing all joints.
- 5.4 Suitable locks shall be provided to hold each filter in position.

**7.6 Ventilation System**

1. General

The ventilation blowers shall be complete in all respects and shall generally comply with the specifications given below :

2. Axial flow fans

- 2.1 The Axial Fan Blades shall be of Cast Aluminium of aerofoil design for high efficiency and high static pressure. The blades shall be joined together on cast aluminium hub.
- 2.2 The mounting ring shall be of CRCA/sheet steel with steel brackets to connect the frame, with the Fan/Motor assembly. Rubber mounts shall be provided between the mounting frame and the mounting brackets.
- 2.3 The fan assembly shall be statically and dynamically balanced.
- 2.4 The fan motor shall be totally enclosed squirrel cage type.

3. Centrifugal blowers

- 3.1 The centrifugal blowers shall be either single inlet single width or double inlet, double width, non-overloading type, of suitable construction. The

blower performance must be rated in accordance with approved test codes and procedures. The centrifugal fans should conform to IS-4894-1987 (Revised to Date)

- 3.2 The blower housing comprising of scroll & side plates shall be accurately cut, be of heavy gauge CRCA all welded sectional construction and reinforced with angle bracings. Outlets shall be flanged to assure proper duct connections. Inlet cones shall be spun venturi type, or curved vane type, to ensure smooth air entry. The base frame shall be of angle iron in bolted/welded construction.
- 3.3 Impeller shall be fabricated from sheet steel with backward curved, properly designed. Blades, with heavy C.I. Hub and shall be both dynamically and statically balanced, to a close tolerance for quiet and vibration free performance.
- 3.4 Shaft shall be of hot rolled steel or forged steel, sized adequately, but in no case of less than 40 mm diameter and shall be accurately ground and polished to a close tolerance.
- 3.5 Bearings shall be self aligning, heavy duty ball or tapered roller type with integral dust and grease seals.
- 3.6 After assembly, the complete fan shall be painted with rust proof primer and two coats of synthetic enamel paint.
- 3.7 Fan having wheel diameter of 1220 mm or more, shall be supplied with split, bolted housing for convenience of handling and installation.

#### 4. Blower drive assembly

- 4.1 Drive assembly for each blower shall consist of blower pulley, motor pulley, a set of 'V' belts, belt guards, and belt tension adjusting device.
- 4.2 Pulleys shall be selected to provide the required speed. They shall be multi-groove type, with section and grooves selected to transmit 33% more load than the required power and shall be statically balanced.
- 4.3 The belt guards shall be of M.S. Sheet duly enameled with angle iron reinforcements and expanded metal screen.

#### 5. Motors and starters

- 5.1 The motor for each blower, shall be squirrel cage induction type and conform to specifications as given under section on control panel, motors and switchgear. The motor H.P. shall be at least 20% more than the limit load of fan and of minimum rating as given under 'Schedule of Equipments'. The Motors shall be as per IS-325-1996 (Revised to date) IP-55 protection for outdoor conditions.

6. Accessories

All necessary accessories shall be provided for proper operation and shall also include (As part of Unit Price).

- 6.1 Dunlop cushy foot vibration isolators for the blowers.
- 6.2 Double canvass connections at the outlet of each fan.
- 6.3 Nuts, bolts, shims etc. As required for the grouting of the equipment.
- 6.4 Slide rails for mounting the motor and belt adjustments.
- 6.5 Bird Screens in the Inlet.
- 6.6 Louvers for Fresh Air and exhaust openings.
- 6.7 Detachable and washable fresh air filters at the inlet.

7. Limitation

- 7.1 The air velocity limits shall be as per Schedule of Equipment and/or specifications but in no case exceed.
- 7.1.1 Velocity at blower outlet shall not exceed 10.16 M/s (2000 FPM).
- 7.1.2 Inlet Velocity shall be limited to 5.08 M/S (1000 FPM)

**7.7 Control Valve and Accessories**

1. Fan Coil Units Controls

- 1.1 Each unit shall have a room type thermostat and a 2-way motorized water valve. The valve shall be fixed at a convenient location. The thermostat shall be complete with the speed control switch ON/OFF and heat/Cool changeover switch as per details given later on the plate shall clearly indicate the fan positions. The controls should be as per specifications.
- 1.2 The motorized control valve shall be 2 position ON/OFF and with 2-way water flow.

- 1.3 The water valves on inlet line shall be of gun metal ball type with integral water strainers, having BSP(FPT) inlet and flare type mpt outlet connection. The valve on return line shall be as above, but without the water strainer.

2. Modulating Motorized Valve for Air Handling Units

- 2.1 Motorized valves for Air handling units shall be 2-way modulating type with bronze body and stainless-steel trim, seat and plug. The valve shall be controlled by an electric actuator mounted directly on the valve. The actuator shall have a reversible synchronous motor and generate the desired stroke by a gear train.

- 2.2 Actuators shall have manual override hand wheel and potentiometer for position feed back and shall be suitable for connection to any major BMS.

- 2.3 The shutoff pressure of the valve shall be sufficient for the system pressure.

3. Temperature Gauge (Thermometer)

Shall be stem type with centigrade & Fahrenheit scales Temperature gauge shall be of the separate able socket type and shall have extended brass stem, where required, for insulated pipes. Temperature gauge shall be installed at water supply and return at air handling units, chillers & condensers as shown on the Drawings. Range of scales shall be 30-120 °F ( 0-50 °C) for air conditioning applications.

4. Pressure Gauges

Shall be installed on suction and discharge of pumps, supply & return at air handling units, inlet and outlet at chillers, and condensers and cooling towers and included in Schedules of Quantities. Suction side gauges at pumps shall be compound gauges with 100mm dia of the range 0-75 cm (0-30 inches) mercury vacuum and 0-4 kg. Per sq.cm (0-60 ps) pressure discharge side gauges at pumps and at all other locations shall be 100 mm dia. Of the range 0.5 kg. Per sq.cm. (0-60 psi) pressure, gauges shall be connected to the pipes by GI nipple, elbow, ball valve etc. as required for gauge protection during testing. Range of scale shall be (0-200 psi). Gauges shall be connected to the pipes by GI nipple, ball valve, elbow etc.

5. Flow Switches

Sockets or necessary arrangements to be made by HVAC Contractor for bellow type flow switches shall be provided in condensing water outlet and

chilled water outlet at the water chilling machines, and at the water cooled condensing units for refrigeration load. The flow switch shall prevent the compressor from starting unless the water flow is established in condensing water lines, and chilled water flow is established chilled water lines.

6. Thermostats (AHU)

6.1 Shall be electric snap-acting fixed differential type as specified herein, with sensing element located in the return air stream. The profile, mounting arrangement and exact location of the thermostats shall be as included in schedule of quantities and as approved by the Project Manager. All thermostats shall supplied with the standard mounting boxes, as recommended by the manufacturer.

7. Thermostat (FCU) with automatic Heat Cool Changeover

7.1 Room temperature controller (Thermostat) for fan coil unit shall have following features.

7.1.1 Internal temperature sensors.

7.1.2 Automatic heat/cool changeover in conjunction with cable temperature sensor.

7.1.3 Input for remote operation mode (BMS) changeover contact switch (NO of NC).

7.1.4 Selectable control parameter On/Off type with 3 position output suitable for 8-30°C setting range.

7.1.5 Rotary set point knob with mechanical min./max. limitation facility.

7.1.6 Fan speed side switch Max. load of 3 speed fan shall be 600 KV.

7.1.8 It shall operate at AC 230 V  $\pm$  10% with a control accuracy of 2°C. Max. power consumption shall be 6 VA.

7.1.9 The heat/cool changeover should be automatic depending upon of the temperature of water in the supply pipe line of FCU.

7.1.10 The changeover mounting kit shall be installed on the supply chilled water pipe line complete with clamping arrangement. It shall have provision for connecting the signal cable to the thermostat for heating & cooling changeover.

8. Energy Metering System

- 8.1 The system shall consist of ultrasonic 'C' flow tube detachable type calculator meter (BTU meter) temperature sensors, necessary modules, signal connector & repeater and necessary software.
- 8.2 The energy meter (Flow tube) shall be based on ultrasonic volumetric flow measurement principle. The flow tube shall be of flanged type connection at both the end with temperature sensors & its attachments facilities.
- 8.3 The flow tube shall be installed on the return chilled water line with 4 or 5 Nos. of FCU's installed in a loop. It shall be able to measure the water flow even if one FCU starts running.
- 8.4 The detachable built in LCD display type calculator (Btu meter) shall have mounting facility on the flow tube or on the wall. The calculator shall be able to give the direct reading in KWH on the display. It shall have the necessary storage facility for a duration of atleast 6 months. The calculators shall have the provision to connect thru necessary M Bus communication module, necessary software, signal located at ground floor or in the basement. The data communicated to the PC shall be stored on MS Excel sheet. The necessary software shall be supplied or create the programme on the PC for monthly billing for each flat separately. UPS power supply to the communication system shall be provided by owner.
- 8.5 The complete system shall include PC pentium-IV (400 M Hz) with 256 MB RD RAM, 80GB Hard disk, 17"SVGA monitor, UPS & rewritable CD drive.

9. Test Points

- 9.1 A test point shall be installed at the inlet and outlet of each pump and balancing valve and heat exchanging equipment like chiller, boiler, condenser, cooling tower, water cooling coil, AHUs etc.
- 9.2 The test point shall be of brass construction ¼" BSP with neoprene sealing bushes and shall be provided with screwed cover.

10. Motorized Butterfly Valves with actuator

10.1 Butterfly Valves

- 10.1.1 The butterfly valve shall consist of cast iron body preferably in two piece construction.

- 10.1.2 The disc shall consist of disc pivot and driving stem shall be in one piece centrally located.
- 10.1.3 The valve seat shall be synthetic material suitable for water duty. It shall line the whole body.
- 10.1.4 The disc should move in slide bearings on both ends with 'o' ring to prevent leakage.
- 10.1.5 The handle should have arrangement for locking in any set position.
- 10.1.6 The valve should be suitable for 12 Kg/cm<sup>2</sup> working pressure.
- 10.1.7 The actuators of motorized butterfly valve shall be BMS compatible.

## 11. Actuator

- 11.1 Each actuator shall have current limiting circuitry incorporated in its design to prevent damage to the actuator.
- 11.2 Actuators shall provide the minimum torque required for proper valve close-off against the system pressure for the required flow.
- 11.3 Two-position or open/closed actuators shall accept 24 or 120 VAC power supply and be UL listed. Butterfly isolation and other valves, as specified in the sequence of operations, shall be furnished with adjustable end switches to indicate open/closed position or be hard wired to start/stop the associated pump or chiller.

## 12. Dynamic Balancing Cum Flow Control Valves

### 12.1 Pressure Independent Dynamic Control Valve

- 12.1.1 Valve shall be electronic, dynamic, modulating, 2 way, control device. Maximum flow setting shall be adjustable to 51 different setting within the range of the valve size. It shall be BMS compatible.

### 12.2 Valve Actuator

- 12.2.1 Valve actuator housing shall be rated to IP44. Actuator shall be driven by 24 VDC motor and shall accept 2010 VDC, 4-20mA, 3-point floating or pulse width modulation electric signal and shall include resistor to facilitate any of these signals. Actuator shall be capable of providing 4-20mA or 2-10VDC feedback signal to control system. Optional fail safe system to power valve to either open or closed position from any position in case of power failure shall be available.  
Extended LED read – out of current valve position and maximum valve position setting shall be standard.

12.3 Valve Housing

12.3.1 Housing shall be ductile iron, ASTM A536-65T, class 60-45-18 rated 4000 kPa static pressure/forged brass ASTM B584 rated 2500kPa static pressure and 120°C.

13. Expansion Tank

13.1 Expansion tank shall be PVC type tank of approved make.

13.2 The outer skin of the tank shall be insulated with 25 mm thick self adhesive polyethylene foam insulation with aluminium foil on one side.

13.3 The inner skin of the tank shall be white.

14. Flow Regulation Unit

14.1 Flow regulation unit shall consist of 316 stainless steel and hydrogenated acrylonitrile butadiene rubber and shall be capable of controlling flow within +/- 5% of each rated flow. Flow regulation unit shall be accessible, for maintenance.

Optional dual pressure/temperature test valves for verifying accuracy of flow performance shall be available for all valve sizes.

## 7.8 Duct Work and Outlets

1. General

1.1 The work under this part shall consist of furnishing labour materials, equipment and appliances as specified necessary and required to install all sheet metal and other allied work to make the air conditioning supply, ventilating, and exhaust system ready for operation as per drawings.

1.2 Except as otherwise specified all duct work and related items shall be in accordance with these specifications.

1.3 Duct work shall mean all ducts, casings, dampers, access doors, joints, stiffeners and hangers.

2. Pre-insulated Ducting – For Air-Conditioning

2.1 Duct shall be fabricated from insulation boards faced with aluminum foil on both sides. The board shall be free of any CFC and HCFC material. For all internal ducts within the building and shafts, the board's thickness shall



be 20mm with 45kg/m<sup>3</sup> density. The thermal conductivity shall be 0.020 W/m K. The aluminum foil shall have minimum thickness of 80μ with embossed finish both side. The fire and smoke classification shall comply with Class O BS 476 part 6.7 and Class A ASTM E 84.

- 2.2 For all external or exposed ducts outside the building, the board's thickness shall be 30mm with 50 kg/m<sup>3</sup> density. The thermal conductivity shall be 0.020 W/mK. The aluminum foil shall have minimum thickness of 200μ with embossed finish. from outer side and 80 μ from other side with embossed finish. The fire and smoke classification shall comply to Class O BS 476 part 6.7 and Class A ASTM E 84.

Water absorption shall be less than 0.5% by 24 hours immersion test.

Water vapour diffusion: M= infinity resistance. The aluminium foil covering the panel to be maintained intact after installation to ensure vapor barrier continuity.

- 2.3 The duct shall be coated with necessary epoxy to provide weather resisting capability. The vendor shall show the client and consultant the installed external duct that has completed minimum 5 years to assess the actual performance of these panels in outdoor condition The panel shall be tested and comply with the following standards:

1. NFPA 101 Life Safety Code Class 'A'
2. ASTM E84 Class "1"
3. **NFPA 255**
4. UL 723
5. Toxicity Index shall not exceed 5.7 according to NES 713
6. Class 'O' according to BS 476 Part 6 & 7

- 2.4 Temperature Range:

No relevant reduction of insulation, chemical or physical characteristics of the panels to be measurable, when conveying air in the temperature range of -35 deg C to +110 deg C.

- 2.5 Pressure Range:

No relevant modification of insulation, chemical or physical characteristics of the panels to be measurable, when conveying air up to the pressure of 1,750 Pascal. Installation shall be supervised & certified by the

manufacturer's representative. Minimum 5-years warranty is required for the insulation material characteristics.

## 2.6 Joint System:

The joints between the ducts shall be using tiger connectors or male – female connection system for small sizes up to 500mm and for bigger sizes more than 500mm aluminum / polymer invisible flanges and slide-in-channel to be used and to be connected by special cover corners, having a holding pin, which goes inside the flange and the insulation, to avoid any field connection and to give the system more strength.

Ductwork shall be installed, using supports, as described in DW144 & according to manufacturer's requirements. Maximum distance between supports shall not exceed:

- 3000mm for ducts with section not exceeding 1200 x 1000mm.

- 2000mm for ducts with section exceeding 1200 x 1000mm.

The boards shall be either PIR (Poly isocyanurate foam panel) or PUR (Polyurethane foam panel). Quote for both types as explained in specifications.

The panel accessories shall be used as recommended and supplied by the board manufacturers. Non locally purchased materials will be allowed. The fabrication of ducts shall be executed exactly as per panel manufacturer instructions using the same manufacturers duct accessories.

The silicon sealant shall be applied for all longitudinal joints. The flange joint shall be with aluminum invisible profile.

The vendor shall ensure to fabricate and install the duct to meet LEED requirements and submit necessary certificates required by LEED consultant. The duct system shall be IGBC or USGBC approved

## 3. Factory Fabricated Duct Work

### 3.1 Material

- 3.1.1 All ducting shall be fabricated of LFQ (Lock Forming Quality) grade prime G.I. raw material furnished with accompanying Mill test Certificates. Galvanizing shall be of 120gms/sq.m. (total coating on both sides).

3.1.2 In addition, if deemed necessary, samples of raw material, selected at random by owner's site representative shall be subject to approval and tested for thickness and zinc coating at contractor's expense.

3.1.3 The G.I. raw material should be used in coil-form (instead of sheets) so as to limit the longitudinal joints at the edges only, irrespective of cross section dimensions.

### 3.2 Governing Standards

3.2.1 Unless otherwise specified here, the construction, erection, testing and performance of the ducting system shall conform to the SMACNA-1995 standards ("HVAC Duct Construction Standards-Metal and Flexible-Second Edition-1995" SMACNA)

### 3.3 Duct Connectors and Accessories

3.3.1 All transverse duct connectors (flanges/cleats) and accessories/related hardware such as support system shall be zinc-coated (galvanized).

### 3.4 Fabrication Standards

3.4.1 All ductwork including straight sections, tapers, elbows, branches, show pieces, collars, terminal boxes and other transformation pieces must be Rolastar, Ducto-Fab , Zeco Equivalency will require fabrication by utilizing the following machines and processes to provide the requisite quality of ducts and speed of supply.

3.4.2 Coil lines to ensure location of longitudinal seams at corners/folded edges only to obtain the required duct rigidity and low leakage characteristics. No longitudinal seams permitted along any side of the duct.

3.4.3 All ducts, transformation pieces and fittings shall be made on CNC profile cutters for required accuracy of dimensions, location and dimensions of notches at the folding lines.

3.4.4 All edges shall be machine treated using lock-formers and roller for furning up edges.

3.4.5 Sealant dispensing equipment shall be used for applying built-in sealant in Pittsburgh lock where sealing of longitudinal joints are specified.

### 3.5 Selection of G.I. Gauge and Transverse Connectors

- 3.5.1 Duct Construction shall be in compliance with 1" (250 Pa)w.g. static norms as per SMACNA.
- 3.5.2 All transverse connectors shall be the Rolamate 4-bolt slip-on flange system, Techno Fab, Ducto-Fab & Zeco imported makes of similar 4-bolt systems with built-in sealant, if any. To avoid any leakage additional sealant shall be used.
- 3.5.3 The specific class of transverse connector and duct gauge for a given duct dimensions shall be 1"(250 Pa) pressure class.
- 3.5.4 Non-toxic, AC-applications grade P.E. or PVC gasketing shall be provided between all mating flanged joints. Gasket sizes shall conform to flange manufacturer's specification.

## 7.9 Pipe Work

### 1. General

All piping work shall conform to quality standards and shall be carried out as per specifications and details given hereunder & shall follow the applicable on relevant Indian standards

### 2. Pipes

- 2.1 All pipes shall be M.S. E.R.W tube (black steel) medium class as per I.S. 1239-79, Part-I with amendment-I of January '81.

### 3. Fittings

- 3.1 The dimensions of the fittings shall conform to I.S.1239/69 Part-II unless otherwise indicated, in the specifications.
- 3.2 All bends in sizes up to and including 150 MM dia. shall be readymade of heavy duty, wrought steel of appropriate class.
- 3.3 All bends in sizes 200 MM and larger dia. shall be fabricated from pipes of the same dia. and thickness, with a minimum of 4 sections, and having a minimum centre line radius of 1.5 diameter of pipes.
- 3.4 All fittings such as branches reducers etc. in all sizes shall be fabricated from pipes of the same Dia. and thickness, and its length should be at least twice the dia. of the pipe.

- 3.5 The branches may be Butt welded straight to the main line, without making a separate fitting, where specified on drawings or required by Engineer-In-Charge.
- 3.6 Blank ends are to be formed with flanged joints and 6 MM thick blank insertion of rubber gasket between flange pair for 150 mm and over, in case where, a future extension is to be made otherwise blank end discs of 6 mm thickness are to be welded on, with additional cross stiffeners from 50 mm x 50 mm M.S. Heavy angles, for sizes upto 350 MM dia. All ends larger than 400 MM dia. shall have dished ends.

#### 4. Flanges

- 4.1 All flanges shall be of mild steel as per I.S. 6392/71 and shall be steel slip-on-type, welded to the pipes, flange thickness shall be as per BS10.
- 4.2 Flanges may be tack welded into position, but all final welding shall be done with joints dismantled. 3 mm thick gaskets shall be used with all flanged joints. The gaskets shall be fibre re-inforced rubber as approved by the Engineer-In-Charge. Special adhesive compound shall be used between flanges of steam, air and gas lines.
- 4.3 Flanges shall be used as follows :-
  - 4.3.1 Counter flanges for equipment having flanged connections.
  - 4.3.2 Flanged pairs shall be used on all such equipment, which may require to be isolated or removed for service e.g. Pumps, refrigeration machines, air handling units etc.
  - 4.3.3 All threaded valves shall be provided with nipples and flanged pairs on both sides to permit flange connections, for removal of valves from main lines for repair/replacement.

#### 5. Valves

##### 5.1 Butterfly Valves

- 5.1.1 The butterfly valve shall consist of cast iron body preferably in two piece construction.
- 5.1.2 The disc shall consist of disc pivot and driving stem shall be in one piece centrally located.

- 5.1.3 The valve seat shall be synthetic material suitable for water duty. It shall line the whole body.
- 5.1.4 The disc should move in slide bearings on both ends with 'o' ring to prevent leakage.
- 5.1.5 The handle should have arrangement for locking in any set position.
- 5.1.6 All valves 200mm Dia. and above shall be gear operated.
- 5.1.7 The valve should be suitable for 12 Kg/cm<sup>2</sup> working pressure.

## 6. Ball Valves

- 6.1 All Valves 40 mm Dia. and below shall be of Gun Metal Ball type Valves with (FPT) female threads conforming to class 2 of IS 778 and mating flanges fitting.
- 6.2 All Ball valves shall be ISI Marked.

## 7. Balancing Valves

- 7.1 The balancing valves up to 80 mm Dia. shall be of gunmetal screwed type conforming to BS 5154 or equivalent specifications.
- 7.2 The valve shall be cast gunmetal ASTM B-62 and complete with non rising spindle. PTFE disc seal cast metal hand wheel.
- 7.3 The port opening shall permit precise regulation of flow rate, by accurately measuring the pressure drop across the port.
- 7.4 The valve shall be completed with two ports for connections to a mercury manometer, to measure the pressure drop, as well as a drain port.
- 7.5 The spindle shall have a shielded screw to set the flow at the desired level.
- 7.6 This valve shall be used wherever specified.

## 8. Duel Plate Check Valves

- 8.1 The body of the check valve shall be made from a single piece casting in cylindrical shape.

- 8.2 There shall be two plates, which shall be hinged in the centre of the circle. Both plates shall have springs attached to them for assisting in closing action of the valve.
- 8.3 There shall be properly/designed metal to metal seal between the plates and the outer body, to ensure non leaking sealing.
- 8.4 The valve design shall confirm to API 594 or equivalent specifications.

9. Automatic/Dynamic Balancing Valve.

- 9.1 Automatic Dynamic Balancing Valve shall be of forged brass (up to 40mm dia.) grey iron (above 40mm dia.) construction of 1350K Pa pressure and 120°C temperature rating. The valves shall have precision calibrated, stainless steel carriage to achieve the desired/pre-fixed flow rates irrespective of the pressure fluctuations in the water lines within a range of 10-210 K. Pa. The flow rate within a tolerance of  $\pm 5\%$  will be achieved by automatic adjustment of the open orifice area in response to the pressure differential changes. The end connection up to 80mm dia. should be threaded and for above 80mm dia. it should be flanged.

10. Strainers

- 10.1 The strainers shall either be pot type or 'Y' type with cast iron or fabricated steel body, tested up to pressure applicable for the valves as shown on the drawings.
- 10.2 The strainers shall have a perforated bronze sheet screen with 3 mm perforation and with a permanent magnet, to catch iron fillings.
- 10.3 Pot strainers shall be provided with flanged connections and 'Y' strainers shall be provided with flanged ends.
- 10.4 The strainers shall be designed to facilitate easy removal of filter screen for cleaning, without disconnection of pipe line.

11. Other Valves

- 11.1 All gauge cocks shall be of gunmetal plug type, complete with siphon (brass chrome plated).
- 11.2 All drain valves shall be of gunmetal with a hose union connection on one hand.

12. 'V' Form Thermometers (Industrial Type)

- 12.1 The body shall be of aluminium alloy with anodized gold colored surface. The casing shall be adjustable sideways for reading from the front. The glass capillary shall be triangular in shape with the blue mercury filled in glass. Scale of reading shall be of the range 0°C to 50°C/32°F to 120°F.
- 12.2 Thermometer shall be suitable for 12 mm connections with long stem, so that thermometer is removable without damaging the insulation. M.S. socket to be welded on pipes shall be provided with thermometer.

13. Jointing

- 13.1 All pipe lines shall be welded type.
- 13.2 Square cut plain ends will be welded for pipes up to and including 100 MM Dia.
- 13.3 All pipes 125 MM Dia. or larger will be beveled by 35 DEG. before welding.

14. Pipe Supports/Hangers

- 14.1 Pipe supports shall be provided and installed for all piping wherever indicated, required or otherwise specified. Wherever necessary, additional hangers and supports shall be provided to prevent vibration or excessive deflection of piping and tubing.
- 14.2 All vertical pipe support shall be made of 10mm M.S. Rods and the horizontal support shall be of M.S. angles of 50x50x4 mm thick.
- 14.3 Pipe supports shall be adjustable for height and prime coated with rust preventive paint & finish coated with black paint using approved grade of paint.

The spacing of pipe supports shall not be more than that specified below :-

<u>Nominal pipe size MM</u>	<u>Spacing (Metres)</u>	
15	...	1.25
20 & 25	...	2.00
32,40, 50 & 65	...	2.50
80,100 & 125	...	2.50
150 & Above	...	3.00



- 14.4 Extra supports shall be provided at the bends and at heavy fittings like valves to avoid undue stresses on the pipes. Pipe hangers shall be fixed on wall and ceiling by means of approved metallic dash fasteners.
- 14.5 Insulated piping shall be supported in such a manner as not to put undue pressure on the insulation, cause condensation. The pipe supports or Saddles shall be of PUF, factory fabricated to suit pipe sizes.
- 14.6 Hangers shall be supported from structural steel, concrete inserts & pipe racks, as specifically approved.
- 14.7 No hangers shall be secured to underside of light weight roof decking and light weight floor glass.
- 14.8 Mechanical equipment shall be suspended midway between steel joints and panel points.
- 14.9 Drilling or punching of holes in steel joint members will not be permitted.
- 14.10 Contractor shall make shop drawing for fixing of support for approval

15. Miscellaneous

- 15.1 Provide all pipe work as required to make the apparatus connected complete and ready for regular and safe operation. Unless otherwise noted, connect all apparatus and equipment in accordance with manufacturer's standard details, as approved by Engineer-In-Charge.
- 15.2 Provide valves and capped connections for all low points in piping system, where necessary or required for draining systems. Provide Isolating valves & Drain valves in all risers to permit repairs without interfering with the rest of the system.
- 15.3 During construction, temporarily close, open ends of pipes with sheet metal caps, where necessary, or required to prevent debris from entering the piping system.
- 15.4 Support piping independently of all equipment so that the equipment is not stressed by the piping weight or expansion.
- 15.5 To facilitate the maintenance, repair and replacement:
  - 15.5.1 Provide shut-off valves where indicated and for individual equipment, units at inlet and outlet, to permit unit removal for repairs, without interfering with the remainder of the system. Additional shut-off valves shall be provided as required to enable all systems to be fully

sectionalized. By-pass and stop valves shall be provided for all automatic control valves as specified.

- 15.5.2 Arrange piping for maximum accessibility for maintenance and repair, locate valves for easy access and operation. No valves shall be installed with handles pointing down, unless unavoidable.
- 15.5.3 Cut the pipes accurately according to measurements, established at building site & work into place without springing or forging.
- 15.5.4 Where pipes are to be buried under ground, they should be coated with one coat of bituminous paint. The top of the pipes shall not be less than 75 CM. from the ground level. Where this is not practical permission of Engineer-In-Charge shall be obtained for burying the pipes at lesser depth. The pipes shall be surrounded on all sides by sand cushions of not less than 15 CM. After the pipes have been laid and top sand cushions provided, the trench shall be refilled with the excavated soil, excess soil shall be removed from the site of work by the contractor.

## 16. Sleeves

- 16.1 Where pipes pass through floors, walls, etc provide Galvanized steel pipe sleeves 50 MM larger than outside diameter of pipe. Where pipes are insulated, sleeves shall be large enough to ample clearance for insulation.
- 16.2 Where pipes pass through outside walls or foundations, the space between pipe and sleeve shall be filled with rock wool covered with GI sheet.
- 16.3 The centre of pipes shall be in the centre of sleeves, and sleeves shall be flushed with the finished surface.

## 17. Arrangement and alignment of piping

- 17.1 All piping shall be arranged and aligned in accordance with the drawings as specified. Where special conditions are encountered in the field, the arrangement and alignment of piping shall be as directed by the Engineer-In-Charge.
- 17.2 The piping shall be installed in a uniform manner, parallel or perpendicular to walls or ceilings, and all changes in directions shall be made with fittings. The horizontal piping shall be run at right angles and shall not run diagonally across rooms or other piping. wherever possible all piping shall be arranged to provide maximum head room.

- 17.3 All piping shall be installed as directly as possible between connecting points in so far as the work of other trades permits. Where interference occurs with another trade whose work is more difficult to route, this contractor shall reroute his pipes as required to avoid interference, at the discretion of the Engineer-In-Charge.
- 17.4 All piping shall be carefully installed to provide for proper alignment, slope and expansion.
- 17.5 The stresses in pipe lines shall be guided and pipes shall be supported in such a manner that pipe lines shall not creep, sag or buckle.
- 17.6 Anchors and supports shall be provided wherever necessary to prevent any misalignment of piping.
- 17.7 Small tubing gauges, controls or other equipment installed on any apparatus, shall not be coiled nor excessive in length, but shall be installed neatly, carefully bent at all changes in direction, secured in place and properly fastened to equipment at intervals to prevent sagging.
- 17.8 The piping shall be grouped wherever practical and shall be installed uniformly in straight parallel lines in either vertical or horizontal positions.

## 18. Testing

- 18.1 In general, tests shall be applied to piping before connection of equipment and appliances. In no case shall the piping, equipment or appliances be subjected to pressures exceeding their test ratings.
- 18.2 The tests shall be completed and approved before any insulation is applied. Testing of segments of pipe work will be permitted, provided all open ends are first closed, by blank offs or flanges.
- 18.3 After tests have been completed the system shall be drained and flushed 3 to 4 times and cleaned of all dust and foreign matter. All strainers, valves and fittings shall be cleaned of all dirt, fillings and debris.
- 18.4 All piping shall be tested to hydraulic test pressure of at least one and half times the maximum operating pressure but not less than 10 kg/cm<sup>2</sup> for a period of not less than 12 hours. All leaks and defects in the joints revealed during the testing shall be rectified to the satisfaction of the Engineer-In-Charge, without any extra cost.

18.5 All the piping systems shall be tested in the presence of the Engineer-In-Charge or their authorized representative. Advance notice of test dates shall be given and all equipments, labour, materials required for inspection, and repairs during the test shall be provided by the contractor. A test shall be repeated till the entire systems are found to be satisfactory to the above authority. The tests shall be carried out for a part of work if required by Engineer-In-Charge in order to avoid hinderance in the work of the insulation contractor.

18.6 Miscellaneous piping, tests with air at 10.5 kg/cm<sup>2</sup> for a minimum of 24 hours without drop in pressure.

18.7 The contractor shall make sure that proper noiseless circulation is achieved through all piping systems. If due to poor bond, proper circulation is not achieved, the contractor shall bear all expenses for carrying out the rectification work including finishing of floors, walls and ceiling damaged in the process of rectifications.

18.8 The contractor shall provide all labors and materials to make provision for removing water and throwing it at the proper place, during the testing or/and after the testing to avoid damages to employer or other contractors' properties. Any damages caused by the contractor to the employer or other contractors' properties, shall be borne by the contractor.

19. Drain Piping

19.1 The drain piping shall be medium class galvanized steel as per IS 1239/1979.

19.2 The fittings shall be of 'R' brand/ "Unik"/Zeolite or equal forged with screwed connections.

19.3 The gate valves shall be of gun metal duly ISI marked on each valve.

19.4 Pipe crosses shall be provided at bends, to permit easy cleaning of drain line.

19.5 The drain line shall be provided up to the nearest drain trap and pitched towards the trap.

19.6 Drain lines shall be provided at all the lowest points in the system, as well as at equipments, where leakage of water is likely to occur, or to remove condensate and water from pump glands.

20. Painting

20.1 All pipes supports, hangers, etc., shall be given two coats of red oxide primer.

- 20.2 All pipes, which are not to be insulated, shall then be given two coat of finish paint, of a type and color, as approved by the Engineer-In-Charge.

## 7.10 Insulation

### 1. General

The Insulation of water piping, air handling units, ducting, chillers etc., shall be carried out as per specifications given below :

### 2. Materials

The materials to be used for insulation shall be as follows, unless some other material is specifically mentioned elsewhere. The detailed specifications of the materials are listed under respective sub heads.

- |     |                       |   |                         |
|-----|-----------------------|---|-------------------------|
| 2.1 | Pipe Insulation       | : | Nitrile Insulation/XLPE |
| 2.3 | Drain Pipe Insulation | : | Nitrile Insulation/XLPE |
| 2.4 | Acoustic Treatment    | : | Nitrile Insulation/XLPE |

#### METHOD OF INSULATION APPLICATION:

1. Pipes shall be thoroughly cleaned with wire brush and rendered free from all foreign matter and grease and primer coated as in item piping.

The pipe should be inspected and all joints should be sealed against leakages.

2. Two coats of rubber based adhesive CPRX compound manufactured by M/s. Shalimar Tar products shall be applied on the cleaned pipe surface.

3. Wrap 500 gauge polythene sheet secured with 18 SWG G.I. wire.

4. Fix 24gauges X 12mm hexagonal G.I mesh and chicken wire mesh tightly over insulation.

5. Apply total 12mm thick sand cement plaster with in 4:1 ratio in two layers each of 6mm thick.

6. Pipes finally shall be provided with two coats of enamel paint of approved make.

### 3.2 Drain Pipe Insulation

3.2.1 The material for insulation of drain pipes shall be pipe section of closed cell elastomeric insulation/nitrile rubber having a 'K' value of 0.027 W/mK at a mean temperature of 10°C and a minimum density of 55 Kg./cubm.

3.2.2 The thickness of insulation shall be a section of 6 mm thick.

## 7.11 Testing and Commissioning

### 1. General

1.1 The contractor must perform all inspection and tests of the system as a whole and of components individually as required, under the supervision of the architect, in accordance with the provisions of the applicable ASHRAE standards or approved equal in addition to furnish necessary test certificates from manufacturers.

1.2 The system shall then be commissioned, tested and balanced to fulfill the intent and purpose for which it is designed.

1.3 In addition continuous Run Tests shall be carried out during peak weather condition.

### 2. Air Handling Units

#### 2.1 Blowers

2.1.1 Dynamic/static balancing of impellers.

2.1.2 Performance test as per applicable codes.

#### 2.2 Coils

2.2.1 Pneumatic test.

#### 2.3 Filters

2.3.1 Test of filter elements as per B.S. 2831 B.S. 1701 as applicable. This is to ascertain filtration efficiency by weight at inlet and outlet.

2.3.2 Manufacturer's test certificates also to be produced for the assembled A.H.U. Final dimensional check will be done. Inspection may be done during assembly of components for quality of workmanship, painting etc.

#### 2.3 Piping

Materials check for specifications and size.

#### 2.4 Valves

Hydraulic./pneumatic test certificates.

2.5 Motors

Manufacturer's test certificate as per motor data sheet.

2.6 Instruments and Controls

Visual examination.

2.7 Special Note

Vendor to note that above procedure is to be followed in addition to the specifications attached with the tender.

3. Associated Works at Site.

3.1 All electrical items will be subjected to inspection at any stage during manufacturing activity. Routine electrical test as per relevant codes. Inspection of manufacturer's test certificates.

3.2 Inspection of raw materials to be used for fabrication and assembly and inspection of manufacturer's certificates.

3.3 Inspection of welding including welder's qualification as desired by inspection engineers. Inspection of fabricated items.

3.4 Pressure testing of pipe fittings used for the refrigerant and water and other services.

3.5 Pressure testing, leak testing of complete piping network for chilled water. (Condenser water and refrigerant/services).

3.6 Checking of electrical circuits (power & controls) and checking functioning of controls of refrigerant systems and other circuits of air conditioning plant.

3.7 Checking of calibration of controls and instrumentation

3.8. Checking of assemblies or electrical control panel, instruments panels, local panels (dimensional and functional) annunciator panels etc.

3.9 Inspection of complete electrical installation at site.

3.10 Performance testing of complete A.C. Plant as per specifications.

4. Vendor Responsibility

- 4.1 The above inspection procedure is given for general guidance and information of vendors. The inspection of purchaser/consultant is strictly not limited to these.
- 4.2 The inspection engineer of purchaser/consultant will have full right, to have detailed inspection at any stage right from placement of order to completion of project, as and when desired by inspection engineer.
- 4.3 Co-ordination of inspection agency of purchaser/consultant with his factory/subvendor's factory/erection site will be the sole responsibility of successful vendor, subsequent to placement of order for complete air conditioning plant, covered under these technical specifications.

5. Piping System

- 5.1 In general pressure tests shall be applied to piping only before connection of equipment and appliances. In no case shall piping, equipment or appliances be subjected to pressure exceeding their test ratings.
- 5.2 Tests shall be completed and approved before any insulation is applied.
- 5.3 After tests have been completed, the system shall be drained and cleaned of all dust and foreign matter. All strainers, valves and fittings shall be cleaned of all dirt, fittings, and debris.

5.4 Water Piping

All water piping shall be tested and proven tight under Hydrostatic pressure of 11 Kg/Cm<sup>2</sup> (150 PSI) or 1.5 times the design pressure whichever is more unless stated otherwise in the specifications. The prescribed pressure shall be maintained for eight hours. In case leaks are detected, the pressure test will be repeated, after the repair of the leaks.

6. Duct Work

- 6.1 All branches and outlets shall be tested for air quantity, and the total of the air quantities shall be within plus five percent (5%) of fan capacity.
- 6.2 Fire dampers, volume dampers and splitter dampers shall be tested for proper operation.

7. Electrical Equipment

- 7.1 All electrical equipment shall be cleaned and adjusted on site before application of power.



- 7.2 The following tests shall be carried out :
  - 7.2.1 Cables and Wires continuity tests.
  - 7.2.2 Insulation resistance tests, phase to phase and phase to earth, on all circuits and equipment, using a 500 Volts meggar. The meggar reading shall be not less than one megaohm.
  - 7.2.3 Earth resistance between conduit system and earth must not exceed half (1/2) OHM.
  - 7.2.4 Phasing out and phase rotation tests.
  - 7.2.5 Operating tests on all protective relays to prove their correct operation before energising the main equipment.
  - 7.2.6 Operating tests on all starters, circuit breakers etc.

## 7.12 Mode of Measurements

- 1. Unit Prices in the Schedule of Quantities
  - 1.1 The Item description in the schedule of quantities is in the form of a condensed resume. The unit price shall be held to include everything necessary to complete the work covered by this item in accordance with the specifications and drawings. The sum total of all the individual item prices shall represent the total price of the installation ready to be handed over.
  - 1.2 The unit price of the various items shall include the following:
    - 1.2.1 All equipment, machinery, apparatus and materials required as well as the cost of any tests which the consultant may request in addition to the tests generally required to prove quality and performance of equipment.
    - 1.2.2 All the labor required to supply and install the complete installation in accordance with the specifications.
    - 1.2.3 Use of any tools, equipment, machinery, lifting tackle, scaffolding, ladders etc. required by the contractor to carry out his work.
    - 1.2.4 All the necessary measures to prevent the transmission of vibration.
    - 1.2.5 The necessary material to isolate equipment foundations from the building structure, wherever necessary.
    - 1.2.6 Storage all equipment apparatus and materials.

12.7 Insurance of all equipment during Transit, storage, installation and up until handing over to the owner.

1.3 The contractor's unit price shall include all equipment, apparatus, material and labour indicated in the drawings and/or specifications in conjunction with the item in question, as well as all additional equipment, apparatus, material and labour usual and necessary to make in question on its own (and within the system as a whole) complete even though not specifically shown, described or otherwise referred to.

2. Measurements of Sheet Metal Ducts, Grilles/Diffusers etc.

2.1 Sheet Metal Ducts

2.1.1 All duct measurements shall be taken as per actual outer duct surface area including bends, tees, reducers, collars, vanes & other fittings. Gaskets, nuts, bolts, vibration rotation pads are included in the basic duct items of the specifications.

2.1.2 The unit of measurements shall be the finished sheet metal surface area in square metres. No extra shall be allowed for lapse and wastages.

2.1.3 All the guide vanes, deflectors in duct elbows, branches, grille collars quadrant dampers etc. shall be measured for actual sheet metal surface and paid for at the same rate as duct of same thickness.

2.1.4 The unit duct price shall include all the duct hangers and supports, exposing of concrete reinforcement for supports and making good of the same as well as any materials and labour required to complete the duct frame.

2.2 Grilles/Diffusers

Grilles / Diffusers should be measured as follows :

2.2.1 All measurements of grilles/diffusers shall be of the actual outlet size excluding the outer flanges.

2.2.2 The square or rectangular grilles/diffusers shall be measured in plain SQ.M.

2.2.3 All round diffusers shall be measured by their diameters in CM.

2.2.4 All linear diffusers shall be measured as per actual length in metres.

3. Measurements of Piping, Fittings, Valves, Fabricated items.

3.1 Pipe

(Including water piping, steam piping, oil piping, LP gas piping, air piping, vacuum piping) etc.

3.1.1 All pipes shall be measured in linear metre (to the nearest CM) along the axis of the pipes and rates shall be inclusive of all fittings e.g. Tees, bends, reducers, elbows etc. Deduction shall be made for valves in the line.

3.1.2 Exposing reinforcement in wall and ceiling and floors if possible and making good the same or installing anchor fasteners and inclusive of all items as specified in specifications and schedule of quantities.

3.1.3 Rates quoted shall be inclusive of providing and fixing vibration pads and wooden pieces, wherever specified or required by the project co-ordinator.

3.1.4 Flexible connections, wherever required or specified shall be measured as part of straight length of same diameter, with no additional allowance being made for providing the same.

3.1.5 The length of the pipe for the purpose of payment will be taken through the centerline of the pipe and all fittings (e.g. Tees, bends, reducers, elbows, hangers, structural supports etc.) as through the fittings are also presumed to be pipe lengths. Nothing extra whatsoever will be paid for over and above for the fittings for valves and flanges, section 3.2 below applies. Rate quoted shall be inclusive of all supports, hangers etc. and no additional measurement would be taken.

3.2 Valves and Flanges

3.2.1 All the extra CI & CM flanged valves shall be measured according to the nominal size in MM and shall be measured by number. Such valves shall not be counted as part of pipe length hence deduction in pipe length will be made, wherever valves occur.

3.2.2 All gun metal (gate & globe) valves shall include 2 Nos. of flanges and 2 Nos. 150 MM long M.S. nipples, with one side threaded matching one of the valves, and other welded to the M.S. Slip-on-flange. Rate shall also include the necessary number of bolts, nuts and washers, 3 MM thick insertion gasket of required temp. grade and all items specified in the specifications.

3.2.3 The rates quoted shall be inclusive of making connection to the equipment, tanks, pumps etc. and the connection made with an installed pipe line shall be included in the rates as per the B.O.Q.

3.2.4 Rates shall be inclusive of insulation, if required.

#### 4. Insulation

4.1 The measurement for vessels, piping, and ducts shall be made over the bare uninsulated surface area of the metal.

#### 4.2 Pipes, Ducts & Vessels

##### 4.2.1 Pipes

The measurements for installation of piping shall be made in linear metres through all valves, flanges, and fittings. Pipes/bends shall be measured along the centre line radius between tangent points. If the outer radius is R1 and the inner radius is R2. The centerline radius shall be measured as  $(R1+R2)/2$ . Measurement of all valves, flanges and fittings shall be measured with the running metre of pipe line as if they are also pipe lengths. Nothing extra over the above shall be payable for insulation over valves, flanges and fittings in pipe line/routings. Fittings that connect two or more different sizes of pipe shall be measured as part of the larger size.

##### 4.2.2 Ducts

The measurements for insulation of ducts shall be made in actual square metres of bare uninsulated duct surface through all dampers, flanges and fittings. In case of bends the area shall be worked out by taking an average of inner and outer lengths of the bends. Measurements for the dampers, flanges, fittings shall be for the surface dimension for the connecting duct, nothing extra over the above shall be payable for insulation over dampers, flanges and fittings in duct routing.

##### 4.2.3 Vessels

The area of standard dished and flat ends of vessels shall be the square of the diameter of the uninsulated body of the shell. Areas for other shapes shall be the actual calculated area. There shall be no deduction or additions for nozzles, handles ribs, dampers, expansion joints etc. All projections on vessels or tanks shall be measured separately as pipe/duct.

#### 4.3 Accessories Insulation

- 4.3.1 The unit of measurement for accessories such as expansion tank, pumps, chiller heads etc. shall be uninsulated are in square metres.
- 4.3.2 In case of curved or irregular surfaces, measurements shall be taken along the curves.
- 4.3.3 The unit insulation price shall include all necessary adhesives, vapour proofing and finishing materials as well as additional labour and material required for fixing the insulation.
- 4.4 Acoustic Duct Lining
  - 4.4.1 In case of acoustic lining of air ducts, measurements of the bare inside duct surface in square metres, shall be final for billing purposes.
  - 4.4.2 The insulation/acoustic panels shall include cost of battens, supports, adhesives, vapour proofing, finished tiles/boards/sheets as well as additional labour and materials required for completing the work.
- 4.5 Roof and Wall Insulation & Acoustic Treatment
  - 4.5.1 The unit of measurement for all underdeck roof insulation, wall insulation, wall/roof acoustic panel shall be the uninsulated area of walls, roofs, to be treated, in square metres.
  - 4.5.2 The insulation, acoustic panels shall include cost of battens, supports, adhesives, vapour proofing, finished tiles/boards/sheets as well as additional labour and materials required for completion of the work.

**NOTE:** All the codes and compliances irrespective of what is mention, shall be the codes and compliances as applicable in Osaka, Japan.

**Makes:** If the makes of the material mentioned herein are not available then the contractor may propose the equivalent product of the “make”/manufacturers which is available in Japan fulfilling the local laws and compliances suitable the functions for which is meant and decisions of Engineer in Charge/ ITPO shall be final.

**Note:** The Code given are indicative however the contractor before procuring & executing the work shall ascertain & determine the applicable Japanese codes, which are required to be complied with Osaka Japan, and only there after the respective material should be used.

## TECHNICAL specifications (BMS)

### 8 Chapter H

Section 1

SYSTEM ARCHITECTURE

1.0 CENTRAL SUBSTATION HARDWARE

The Control stations shall comprise of Personal computers (PC) providing high level operator interface with the system the terminals shall be capable of providing the operator with the facility for remote system interrogation, control, retrieval/storage of logged data, annunciation of alarms and reports, analysis of recorded data and the formatting of management reports.

The control station shall consist of the following hardware with all of them suitable for the power supply voltage of 230 V AC  $\pm$  10% , 50 HZ.

Minimum Specifications for Workstations

FEATURES	DESCRIPTION
Processor	I 7 ( 3.0 GHZ )
Drive controllers	Integrated serial ATA controller (ICH9R) 3 Gb/s with RAID 0, 1, 5 and 10 capability.
Cache	1 MB L2 Cache
RAM	16 GB DDR RAM
Slots	7 full length slots: 2 PCI Express (PCIe) x16 graphics, 1 PCIe x8 (x4 electrical) slot, 1 PCIe x1 slot, 3 PCI slots
Hard Disk	500 GB SATA Hard Drives x 2
Power Supply	230 V switchable/50 Hz
Video	NVIDIA Quadro FX370 (256 MB,)
Ports	Ports Front: 3 USB 2.0
Operating System & Software	Windows 10 & 1 No. Microsoft office software shall be provided.
Antivirus Software	Norton

Network	100 Mbps Network Interface Card with wake on LAN support
DVD ROM	Built in 52X DVD ROM with speakers

- a. Key board: The central station shall be complete with detached 101-keys keyboard which includes full upper/lower case ASCII keyset, a numeric pad, dedicated cursor control pad, and a minimum of 10 programmable functional keys.
- b. Colour Monitor LCD / TFT (Touch Screen Type): The colour LCD shall be with a minimum 22-inch diagonal non-glare screen, display resolution 1920 x 1080P, aspect ratio 16:9.
- c. Mouse: For keyboard less operation, in addition to the enhanced keyboard, a mouse shall also be provided as an alternative user interface for day to day system operation. 1 No. mouse pads shall be provided for each mouse.
- d. Printers: The contractor shall provide printers for printing alarms, operator transactions and reports.

There shall be one printer with each Control Station. This printer shall be dedicated for alarm printing and for printing reports, trend log, summary, totalizer logging, recording alarms and providing system reports, overriding auto printing etc. The printer shall have the following characteristics:

- i. The printers shall be Laser color type.
  - ii. Printer speed for B/W printing shall be minimum 15 pages (A3) per minute.
  - iii. Full toner shall be provided.
- e. The available PCI slots on the PC shall be used only for communication cards and shall not be utilized for mounting protocol converter cards.
  - f. Original CD of Software ( Window 07 MS office software, BMS software, Printer, Antivirus etc.) shall be furnished to ITPO.

### 3. CENTRAL STATION SOFTWARE

#### ***USER PROGRAMMABLE SOFTWARE***

The system shall have a flexible software package to allow an operator with minimal knowledge of software programming to construct programs for plant control and

management information. All system software shall be field proven. System architecture shall be truly client server in that the Workstation shall operate as the client while the supervisory controllers shall operate as the servers. The client is responsible for the data presentation and validation of inputs while the server is responsible for data gathering and delivery. Tenderers shall quote for tested and proven software. Some of the followings are as under:

- a. All programming shall be done in clear English language.
- b. The system shall hold a complete set of instructions in the software which can be viewed by the operator whilst in the operating mode.
- c. The system shall provide run simulation of the programs to allow operator verification before the program is down loaded to the controllers.
- d. It shall be possible to assign alarm functions to any programs created as required.
- e. Full arithmetic operators shall be available for use in the programs as required
- f. Program shall permit the use of comparison statements such as : =,>,<,<= etc.
- g. Program shall permit logical operators to be used such as : NOT, AND, OR, AND MASK.
- h. Direct reference to any point shall be available to obtain its current value. Such references shall be using standard language such as, ON, OFF, MANUAL, SETPOINT, EXPIRED TIME, PRIORITY, ALARM.
- i. It shall be possible to refer to time and calendar functions directly, so that DATE, TIME, HOUR, MINUTE functions may be used.
- j. It shall be possible to use such mnemonics as ABS (absolute value), SQRT (square root), INT (integer), MAX (maximum), AVG (average) etc.
- k. It shall be possible to set timers so that a timed delay may be introduced before an action is carried out.

**The following Software shall be provided besides the software for automation system :**

Operating System	-	Windows 10
Memory Manager	-	QEMM Version 5.11 (or higher)
Multitasking	-	Desk view version 2.31 (or higher)



- |                     |   |  |
|---------------------|---|--|
| Mouse Driver        | - | Microsoft bus mouse 6.2                          |
| Data Base Manager   | - | SQL SERVER 2005 OR HIGHER                        |
| Maintenance Manager | - | Shall be able to perform the following functions |
1. Easy to use Web based internet ready application. Application access based on logged-on user's role (Technician, Supervisor, Manager).
  2. Manage Asset, location, spare parts, maintenance schedules, inventory and purchase requisition information.
  3. Create and manage planned (Preventive) and unplanned (corrective) work orders.
  4. Track all work orders till their completion and record maintenance costs.
  5. All work order status change history are recorded.

Management station software shall also be provided all the functions to manage application software packages within a Pre-emptive Multitasking environment.

It should be possible to run at least five third party software's in the multitasking environment.

The following user programs must be processed by the Control Station:

**i. Operating functions:**

Graphic management schematics with dynamic display of actual status information. manual control of parameters and status variables of the electrical and mechanical plant. manual switch of programs which are not part of progress routines.

**ii. Monitoring functions:**

Automatic monitoring of connected plant and equipment automatic monitoring of the system (idle or operation)

**iii. Data visualization functions:**

For the individual processing of operating data for Building Management.

**iv. In standardized form for:**

- a. Trend reports
- b. Consumer statistics
- c. Fault statistics
- d. Maintenance management

v. **Display functions :**

For the representation and display of operating data and management information in alphanumeric and graphic form.

vi. **Management functions:**

- a. For optimization of energy consumption.
- b. For rational use of personnel

vii. **Access control functions :**

Different operating levels for all information and all data by way of code word or user key.

viii. **Commissioning functions :**

For system specific software of the field stations and the management system downloading the system specific software to the DDC units. testing of the software in connection with electrical and mechanical plant. automatic and periodic storage of all system data.

ix. **Test functions :**

Automatic and continuously running test functions for system tests (hardware and operating software) and management system configuration (communication) Test tools for individual hardware and software components which can be activated manually. Self test functions for individual system components which can be activated through manually command.

### **3.2 OPERATOR INTERFACE**

All communications between the operator and the system shall be in clear language, without reference to special code or codes. Generation and editing of software shall be via clear English language menus.

### **3.3 PASSWORD ACCESS**

- a. None of the features of the Operators Panel shall be accessible without the user first being required to log on by entering a password.
- b. Alpha numeric passwords of up to 15 characters shall be available and definable by individual operators.
- c. It shall be possible to grant or deny access to any terminal and/or functions for individual user. The ability to use this feature itself shall also be definable.
- d. It shall also be possible to grant or deny access to individual points or groups of points by function or type.
- e. It shall also be possible to define a timeout value for individual user. Automatic log-off of the operator shall occur if no keyboard or mouse activity is detected during this timeout period. It shall also be possible to allocate an infinite timeout.
- f. A log of at least previous 100 users shall be available at each control station. A record of the user's name, the time and date of log ON and log OFF shall be available from this file.
- g. Password summary shall be available to the operators with the highest level of access. Password shall not be displayed.
- h. Password data base shall be stored in server as well as in workstation in an encrypted form so that the failure of any one device shall not make the system inoperative.

### **3.4 CONTROL STATION GRAPHICS CAPABILITIES**

The work stations shall have Graphics as the basis of operation. The software shall have following advanced techniques for ease of operation:

- a. Colour banding of screen displays shall be provided for display and differentiation of normal and abnormal signals. This shall allow operator instant recognition and response to critical building operation.
- b. To provide instantaneous confirmation to system operator of equipment status, graphic screen animation shall be provided. This shall allow full color animated displays of equipment in site layouts, building floor plans, and other system configurations. All graphic displays shall be online programmable via keyboard or mouse selection of graphic library stored symbols and system profiles. Fully implemented graphic displays are to be provided for all systems

- so identified in the Input/output Summary section of this document.
- c. System Shall have the capability to allow operator to observe multiple dynamic graphic screens at the same time to enable operator to manage several separate building operation tasks concurrently.
  - d. To enable operator to “find” his way in and out of the system, a stacked display of windows shall be included to provide orderly reference. Operator option of enlarged full screen display at any penetration level shall also be included.
  - e. Alarm class differentiation shall provide storage requirements for different alarms.
  - f. Graphic driven point identification and selection shall be provided to allow operator to select a point by “clicking on” the graphic symbol representing the point type. Consequently, display will appear to enable the operator to select the desired command.
  - g. The system shall be capable of running programs in both the foreground mode and back-ground mode simultaneously. The system running only foreground “window” while keeping the other programs dormant in the background “window” shall not be acceptable as this slows down the availability of control and essential information to be made available to the operator in the system.
  - h. Capability of on-line graphics generation shall be a major requirement i.e. the operator shall have the ability to create new graphics on-site from a menu of symbols.
  - i. Historical system trouble, fault, false alarms shall be stored on line in the hard disk for trouble analysis.
  - j. It shall be possible to define upto 12 functional categories in the plant schematic each of which shall be removable from the screen individually. This shall allow the operator to delete temporarily any equipment and have a better overview of the other sections of the system.
  - k. Maintenance software such as inventory control, work orders shall also be on-line with the historical data- file for proper maintenance of the system.
  - l. Data Base Manager shall manage all data on an integrated and non-redundant basis. It shall allow addition and deletions to the data base without any detriment to the existing data. Cross linkages shall be provided such that no

data required by a software program can be deleted by the operator until that data has been deleted from its respective programs.

- m. Dynamic data such as temperature and humidity values, fans and motor status, alarm point condition, etc. shall be embedded in the graphics as the sensing location. Points in alarm condition shall annunciate by colour changes and flashing/blinking icon, symbol, or value.
- n. Commendable points shall be uniquely identified by colour and/or discrete symbol and shall be directly addressable and commendable from the graphic display. It shall not be necessary for an operator to type in command request or point names. Direct entry of commendable point address or positioning of the cursor to the point shall cause a display of associated command states for digitals, the set point value and valid range for analogs. Cursor positioning shall be via a "mouse".
- o. In order to allow the operators to view graphics in greater detail, zoom/pan display feature shall be provided to return zoomed/panned graphics to their original status. A "return to original" feature shall also be provided. The mouse shall be used to pan in all directions in real time, and to jump, from any section of the plant schematic directly to another section or to another level.
- p. It should be possible to use touch screen monitor for viewing and control of graphic software.

### **3.5 USER INTERFACE**

The operator panel on a terminal shall provide the primary interface for operator access to the BAS ( Building Automation System ) while also providing a vehicle for the annunciation of alarms and the reporting function. The operator shall have the option of switching between a text based and graphic based user interface at any time. In particular following standard functions shall be provided.

- a. It shall be possible to carry out the following commands by use of dedicated function keys on the keyboard and by the mouse :
  - i. ON - digital points
  - ii. OFF - digital points
  - iii. AUTO - analogue and digital points
  - iv. SET TO VALUE - analogue points
  - v. ALARM REVIEW
  - vi. POINT TYPE REVIEW
  - vii. POINT GROUP REVIEW

- viii. HOURS RUN REVIEW
  - ix. REVIEW CANCEL
  - x. GRAPHICS ENABLE
  - xi. HELP
  - xii. ALARM ACKNOWLEDGE
- 
- b. It shall be possible to add new points, and reconfigure or modify existing points without taking any part of the system off-line. It shall be possible to change designation of operator passwords, access levels, point segregation and auto sign off, designation of backup consoles and printers. It shall also be possible to add/change descriptors for points, segregation groups and access levels, and action messages for alarms and trouble condition, system/point enable/disable, input or output value, and assignment of alarm/warning limits. All additions and modifications shall be on-line programmable via operators' keyboard and then down line loaded to distributed processing units.
  - c. It shall be possible to address plant, zones, points etc. using clear language descriptors. Each individual point may also be identified by a unique alphanumeric mnemonic address entry. Simple key names may be assigned to points to allow direct display. These key names shall be fully operator assignable and depending on how frequently they have to be accessed, they may be as simple as one, two or three characters or as lengthy as 20 characters.
  - d. The operator shall be able to access any point on any graphic without going through the penetration path. Graphics shall be menu-driven. Direct access to graphics shall be menu selectable wherein the operator may select optionally by entering the name of the graphic system desired or by selecting the desired graphic via cursor positioning.
  - e. It should be possible to identify some points which are frequently addressed as "frequent access" points. This listing shall be selectable from a screen top menu bar drop down menu item with a user address, descriptor and value/status of each "frequent access" point displayed.
  - f. A wild card search utility should be provided which shall be operated by a partial data entry. For example, by listing chiller 1, all chiller no. 1 points shall be listed.
  - g. The information displayed for individual points during a review shall be
    - i. Its unique mnemonic address
    - ii. Its current state or value (in Engineering units)
    - iii. Its type of point (analog/digital, input/ output)
    - iv. Any secondary or tertiary value

- v. Reason for state, if applicable
- h. An Electronic message facility shall be provided on the operator station for any operator to enter a message to another operator of the same station or different station, by selecting the receiving operator's ID and entering the message. When the operator with a queued message, signs onto the operator station, a "mail message waiting" prompt shall be issued. Upon displaying a mail message, the display shall prompt the operator with three message options to execute, delete, print, and save. Messages shall also include the senders personal ID and a brief title or subject description.
- i. Dynamic data shall be automatically updated on the central station. Manual update shall also be provided via a screen update key.
- j. It shall be possible to enter any of the subroutines such as the editor functions, or the Data Manipulation function from the central station without closing down the terminal or the programs currently running.
- k. The operator shall be provided with the facility to override the use of portable operator's terminal.
- l. Web stations shall have the capability to automatically re-direct to an HTTPS connection to ensure more secure communications.

### **3.6 HELP FACILITY**

- a. Software shall be provided to facilitate programming and storage of the system operation manuals in the hard-disk. The operation manual shall be retrieved by On Line Help mode so as to enable the operator to self-learn the system operation, command, or function as and when needed.
- b. This 'help' facility shall be made available to the operator by use of a dedicated key or a single key click on the mouse. A minimum help shall be available for every menu item and dialogue box.
- c. The facility shall contain both text and graphics to provide information about the selected function directly.
- d. The information provided shall be in simple clear language and shall be capable of being updated along with new version. Modification in help file shall not be allowed.

### **3.7 ALARMS**

- a. Multiple priority levels of alarm shall be made available. Priority levels shall be deemed Critical Alarms and Non-critical (general) Alarms. Normally, critical alarms shall take precedence over non-critical alarms, and high priority over low priority.

- b. Each analog point shall have the following limits defined; wherever required
  - i. High priority critical alarm limit
  - ii. Low priority critical alarm warning limit
  - iii. Low priority warning limit
  - iv. Low general alarm limit
- c. When an analog point goes outside the low priority critical alarm limit or Low priority warning limit, a user defined warning message shall be directed to the appropriate alarm printers at the control station.
- d. The Warning limits shall be used to monitor controllability, not comfort conditions. The alarm limits shall be used to monitor comfort conditions. When a setpoint is changed, the warning limits shall automatically change while the alarm limits shall not change.
- e. When an analog point goes outside any of the limits defined, a user defined alarm message for that level shall be directed to the appropriate alarm printer and to respective operator workstation. Alarm message shall require operator acknowledgement.
- f. When a digital point goes into alarm, a user defined alarm message shall be output to the appropriate alarm printer and to respective control station. Alarm messages shall require operator acknowledgement.
- g. When a point is overridden by operator command from an operator workstation or a local workstation, an alarm message shall be output to the appropriate alarm printer and to respective operator workstation. Alarm messages shall require operator acknowledgement.
- h. When a point returns to normal, the event shall be recorded in control stations as 'Return to Normal'.
- i. The Operator workstations shall be capable of displaying a list of all points in alarm for the building in a single summary. Systems which require the operator to make a separate summary for alarms, shall not be acceptable.
  - i. Annunciation: Alarms shall be annunciated at a terminal by an audible tone and icon. Critical alarms shall be defined by a different colour than non-critical alarms.
  - ii. Printing: Alarms shall automatically be printed on the defined alarm printer. The printout shall contain the address, state or nature of the alarm, alarm priority, and time and date of occurrence. It shall be possible to route alarms to any printer on the system, in case the allotted printer fails.



- iii. It shall be possible to produce a user definable full text message to accompany the annunciation of any alarm. This shall provide further information about the alarm and any action required to be taken by the operator or indicate that action is automatically programmed in the system. These messages shall be automatically printed on a designated printer. There shall be no practical limit to the length of messages created.
- iv. Acknowledgement: It shall be necessary for all alarms to be acknowledged by an authorized operator. The facility shall exist for an additional message to be appended at the time of acknowledgement to provide further information as to any action taken.
  - a. Acknowledgement of alarms shall be automatically printed and will indicate the time, date, and any message generated by the operator.
  - b. Alarm silencing shall be by the authorized operators by pressing the silence key.
- v. Alarm Clear: When alarms are cleared, then a message shall be produced to indicate the description of the alarm point, its current state, and the time and date.
- vi. Disk Records: With the exception of extended text messages, all the information produced above, alarm annunciation, acknowledgement, and clearing, shall be automatically recorded on the fixed disk for historical purposes.
  - a. Alarm Inhibits: It shall be possible to inhibit the transmission of alarms in the following ways
    - 1. Operational Inhibits - to allow time for stabilization of power after the normal power is restored.
    - 2. *Transient Inhibit - to make allowance for fluttering contacts or allow internal responses.*

It shall be possible to select time periods for inhibits (i) and (ii) and may be applied when entering into alarm, out of alarm, or both.
- vii. Point lockout: It shall be possible for the operator to lockout the control for any point, to force it to remain in its current state.
  - 1. A summary showing locked out points shall be available. Systems which require the operator to make a separate lockout summary shall not be acceptable.

2. Alarm Review: Points in alarm shall be displayed on the operator's panel using the alarm review function.

### 3.8 LOGGING

- a. It shall be possible to log the status or value of system points at regular intervals or on change of state and store this on hard-disk at any of the central station.
- b. It shall be possible to archive this information for future reference.
- c. In the case of timed interval logs, it shall be possible to specify a time interval (in minutes) and the points which are required to be logged.
- d. Storage of logged information shall be able to be carried out in any of three ways, single-shot, roll-over, or split. These are defined as follows: -
  - i. Single-shot: In this type of file, logging shall be carried out only during a pre-defined period for which the start and finish time and date shall be configurable.
  - ii. Roll-over: This file shall be wrap-around where oldest data shall continuously be overwritten by new incoming data. It shall be possible to configure the number of records to be stored or the duration in hours, days or months before wrap around occurs.
  - iii. Split: Data shall be continuously stored in a series of files automatically created. The change-over or creation of subsequent files shall be created by splits at user-defined boundaries. The boundaries shall be able to be defined by duration (hours, days, months) and by time and day of the first split.
- e. Logging files shall be terminal based not system based, to provide true multi-terminal capability.
- f. Data produced by the logging facility must be able to be used by standard spread-sheet package for the analysis of information and the preparation of management report.
- g. In addition to the above, the data may be presented in a simplified customized package. The package should have the following features as minimum:
  - i. Charting of logged data on disk in line graph, bar graph or pie format.
  - ii. Presentation of logged data on disk in tabular format.

- iii. Charting of dynamic data (up to 8 points) in real time.
- iv. Presentation of dynamic data in tabular format in real time.
- v. Selection of Auto/ manual scaling of X(time) axis and Y(variable) axis.
- vi. Tailoring of charts by selection of line width and background colours.
- vii. Optional grid overlays (full and dotted lines).
- viii. Selection of horizontal/ vertical arrangement of windows or a 'cascade' presentation.
- ix. Multiple Windows.
- x. Printing of completed presentations.
- xi. User configurable data selections.
- xii. Optional display of point titles.
- xiii. Selection of primary or secondary values for display.
- xiv. Presentation of both analog and digital values (ON/OFF etc.).

### **3.9 REPORT GENERATION**

Standard reports shall be provided, which shall be operator selectable to appear on the operator station, any selected printer or both. A "terminate report" command shall be available to allow the operator to stop any report in the process of being printed. Standard pre-formatted reports to be provided shall include:

- a. Point summary reports may be requested at any penetration level. Point summary reports shall include the current value/status and condition, point descriptors and all relevant information. Point summary reports shall be selectable for all points.

All reports shall be capable of being scheduled to run at a specific time and/or interval via an operator function supported by necessary data entry templates and interactive prompts.

- b. As a minimum, the system shall provide the following summaries:
  - i. Point summary
  - ii. Alarm summary
  - iii. Limits summary
  - iv. Lockout summary
  - v. Off-line summary
  - vi. Override summary
  - vii. Utility summary

- viii. Point status (alarm, locked out, off-line, override)
  - ix. Point name
  - x. Point status/value (automatically updating)
  - xi. Engineering units.
- c. The alarm summary shall list all points in alarm in the selected system. It shall be possible to print on a single summary, all points in alarm in the building. As a minimum, the alarm summary shall include:
- i. Point name
  - ii. Point status/value (when alarm occurred)
  - iii. Alarm message
  - iv. Date and time of alarm occurrence
- d. The limits summary shall list all the alarm limits, and warning limits.
- e. The lockout summary shall display points in the selected system which have either reporting or triggering locked out.
- f. The off-line summary shall display points in the selected system which have lost communication with the system.
- g. The override summary shall display points in the selected system which have been overridden by operator command.
- h. The utility profile shall display the total consumption, measured peak for the current period and the previous period.
- i. Trend reports shall allow the operator to randomly select logical group of points to be recorded at selectable time intervals. It shall be possible to assign up to ten variables to each trend report. The format, headers, footers, and calculations shall be selectable by the operator. The trend report shall be stored to disk and shall be subsequently capable of being displayed, and/or printed by the operator.
- j. Dynamic trends shall provide up to eight points and show real time activity of the associated points. This information shall be printed and/or displayed in numeric, bar chart, curve plot, pie chart, etc., as selected by the operator. Graphic plots shall allow a unique color for each point. Sample interval of points selected for dynamic trend shall be user selectable. 3-Dimensional dynamic trending must be provided in the system.
- k. Alarm and run time reports shall be automatically issued to assigned printers immediately upon occurrence, and shall consist of the point with engineering unit, the time, and the date, and the alarm message.

### **3.10 DATA STORAGE**

A history file capability shall be provided to allow automatic storage of certain records plus allow the operator to selectively direct critical real time system data and activity to a mass storage device for later recall and analysis.

- a. All alarm and return to normal activity shall automatically be routed to history files. Alarms and return-to-normal shall include warning and alarm threshold violations with no-response, trouble, run time exceeded, demand alarms, and

command failures. It shall be possible to request a report by specifying points of interest, the time window of interest and the type of alarms of interest. Locking out or disabling of points shall also be historically stored and output in the all- type reports.

- b. Operator shall be able to select, via the CRT terminal keyboard, those analog and digital inputs and outputs to be stored and the interval at which samples are taken.
- c. It shall be possible to access software packages such as Lotus 1-2-3 or similar, so that the operator may format display or printouts in the form of:
  - i. Spread sheets.
  - ii. Bar charts.
  - iii. Curve plots.
- d. History files shall be the source data for stored trend reports to be used for records and system analysis. Operator shall be able to select specific points to be trended, the time period of the trend, the sample interval, and time at which the report is printed. Trend output format shall be as specified for trend logs (shaded, un-shaded etc.)

### **3.11 UTILITIES**

The Central Station personal computer (P.C.) shall be provided with the following menu selected graphic system utilities or desktop application packages.

The system provided must be capable of running standard software packages concurrently with the real time system. System should be capable of supporting third party software packages like spreadsheet, word processing etc.

- a. All third-party software packages identified shall have access to the system historical data base.

### **3.12 TIME SCHEDULING**

- a. There shall be real time clock facility to help in time scheduling. The scheduling feature shall not be dependent on a central database or an operator workstation.
- b. The following commands shall be able to be time scheduled to be issued at a later day and time from the operator workstation or portable workstation:
  - i. Start and stop a point
  - ii. Adjust analog value
  - iii. Change set point

- c. The following commands shall be able to be time scheduled to be issued at a later day and time from the operator workstation:  
Change alarm limits or warning
  - 1. Lock/unlock point reporting or point control
  - 2. Demand limit target setting
  - 3. Load rolling target setting
  - 4. Reset tracking period for energy statistics
  - 5. Trend point enable/ disable for a point
  - 6. Totalization enable/ disable for a point
  - 7. Reset totalization value
  
- d. The following summaries shall be able to time scheduled to be printed or stored in a disk file at a later day and time from the operator workstation:  
Standard point summary
  - 1. Alarm summary
  - 2. Off-line summary
  - 3. Override summary
  - 4. Disabled summary
  - 5. Lockout summary
  - 6. Utility summary
  - 7. Alarm limits summary
  
- e. Commands shall be able to be issued repeatedly on specified days of the week at specified times.
  
- f. A system wide calendar shall be set up to define each day as:
  - 1. Regular day
  - 2. Special day
  - 3. Holiday

The system wide calendar shall be stored in multiple locations so that the failure of any one device does not cause the system to fail.

The calendar shall automatically accommodate the leap year and the turn of the century.

The calendar shall allow the days to be scheduled one year in advance from the current system date.

- g. Separate schedules shall be stored for:
  - a. Regular days
  - b. Special days
  - c. Holidays
  
- h. The system shall accept one-time schedules to accommodate overtime usage. One-time schedules shall be automatically deleted from the system after execution.
- i. The system shall allow one-time schedules to be programmed up to one year in advance.
- j. After recovery from a power failure, the system shall determine any time scheduled commands which should have been issued during the period that the power was off. These commands shall automatically be issued.

### 3.13 POINT HISTORY

- a. For every analog point in the system, a 48-hour record of the value sampled on regular interval shall be maintained. The operator shall choose whether samples older than 48 hours shall be discarded or archived. The most recent 48 hours of analog point history shall be able to be displayed at the Control Station.
  
- b. For every digital point in the system, a point history of the last 10 change of states shall be maintained. The operator shall choose whether point history previous to the last 10 change of states shall be discarded or archived.

The most recent 10 samples of digital point history shall be able to be displayed at the Control Station.

- c. Point history samples with time/date shall also be taken under the following conditions:  
Point in alarm/return to normal
  - i. Point overridden/released by operator
  - ii. Point on-line/off-line
  - iii. Point reliable/unreliable

A report shall be available showing all points for which point history is being archived.

- d. The system shall provide point history graphs for analog / digital points.

### 3.14 POINT TREND

- a. The trend feature shall be able to record any of the following parameters for any point:
  - i. Point value
  - ii. Point alarm status
  - iii. Controlling feature
  - iv. Operator override flag
  - v. On-line/Off-line flag
- b. The operator shall be able to select points and define any interval on which samples may be taken.
- c. For long term storage of samples, trend data shall automatically be updated.
- d. A report shall be available listing all points being trended. The report shall display:
  - i. Trend status
  - ii. Point name
  - iii. Parameter being trended
  - iv. Display units
  - v. Sample interval
  - vi. Number of samples taken.
- e. A trend for a point shall be able to be started either by operator command or according to a time scheduled command. A trend for a point will end as a result of an operator command, time scheduled command or when the required number of samples have been collected.
- f. Trend samples shall be displayed in either tabular or graphical format. A minimum of eight trended points shall be able to be displayed concurrently on a graph or report.
- g. The trend graph display shall automatically scale the value and time axis to display all samples. From the trend graph, the operator shall be able to select and read the instantaneous value of any previous sample.
- h. The trend point graphing capability shall be a built-in feature of the system and shall not require operator set-up. Systems which require trend point data to be exported to third party software shall not be acceptable.

### 3.15 TOTALIZATION

- a. For every digital point, the system shall be able to calculate:
  - i. Cumulative on-time
  - ii. Cumulative off-time



- b. For every point, analog and digital, the system shall be able to calculate:
  - i. Cumulative time in alarm
  - ii. Cumulative time overridden by operator
  - iii. Cumulative time off-line
- c. Time totalization shall have a resolution of one minute or less.
- d. Time totalization shall be displayed in hours.

### **3.16 DATA BASE MANAGER**

Control station software shall include a data base manager to allow the data to be managed on an integral and non-redundant basis.

### **3.17 SITE SPECIFIC DATA MANIPULATION SOFTWARE**

A site-specific data manipulation software feature should minimum be provided to allow the user to modify and tailor the BAS software to the changing requirements at the site. The modifications shall be carried out on-line.

### **3.18 SOFTWARE INTERFACE**

The BAS shall be interface seamlessly on a software platform with fire alarm system, secondary chilled water pump, lift, VFD, Baggage system, DG PLC, FIDS and energy meters.

-O-O-O-

## Section 2

### CONTROLLER AND FIELD DEVICES

#### **1.0 DIRECT DIGITAL CONTROLLER**

##### **1.1 DIRECT DIGITAL CONTROLLER (DDC) HARDWARE REQUIREMENT**

- a. Supervisory controller shall perform key functionality such as control logic, trend logging, and alarm supervision and support communication and connectivity to the I/O and field buses. Supervisory controller shall be able to run multiple control programs, manage local I/O, alarms, and users, handle scheduling and logging.
- b. Supervisory controller shall have 512 Mb of RAM and eMMC memory of 4 GB. The supervisory controller shall have capacity expandable to 400 points or as approved by consultant per controller.
- c. Supervisory controller shall have following ports:
  - I. Two 10/100 Ethernet ports
  - II. Two RS-485 ports
  - III. One built in I/O bus port
  - IV. One USB host port
  - V. One USB device port
- d. DDC controllers shall be capable of fully “stand- alone” operation i.e. in the event of loss of communication with other DDC’s or Control Station, they shall be able to function on their own.
- e. The controllers shall consist of 32-bit dual core microprocessors, based with EEPROM for operating system (O.S.) and a battery backed RAM (minimum 128Kb capacity) for storage of operating data. All DDC controller shall be CE & UL listed.
- f. Each DDC shall have 128 MB of Internal RAM for data storage, 32 MB ROM.
- g. Each Controller shall have a nickle-cadmium/lithium battery to support the full operation of the RAM upto 12 hours in the event of a localized mains failure. The battery is required for operation of actuators, valves, dampers etc.

- h. In addition to the above battery reserve a further battery shall be provided to retain the RAM for a minimum of 7 days, after the expiration of the standard battery. In case the memory is stored on EEPROM, the battery backup will not be required.
- i. DDC architecture of Input/output (I/O) modules placed outside the Controller are also acceptable.
- j. The Controllers shall have proportional control, Proportional plus Integral (PI) Control, Proportional plus Integral plus Derivative (PID) Control, Two Position Control and Time Proportioning Control and algorithms etc., all in its memory and all available for use by the user, i.e. all the control modes shall be software selectable at any time and in any combination. The analog output of Proportional Control, PI Control and PID Control shall continuously be updated and output by the program shall be provided. Between cycles the analog output shall retain its last value. Enhanced integral action in lieu of Derivative function shall not be acceptable.
- k. The controllers shall have a resident real time clock for providing time of day, day of week, date, month and year. These shall be capable of being synchronized with other clocks in the network.

Back-up power shall support the clock. Upon power restoration all clocks shall be automatically synchronized.

- l. The microprocessor based DDC's shall be provided with power supply, A/D and D/A converters, memory, and capacity expandable to capacity of 128 points or as approved by consultants per controller as per required in AC plant room and electrical room. However, for locations other than plant-room minimum point capacity shall be 16 input/output (I/O) hardware points.
- m. If the controllers provided by the contractor have the configurable plug in function cards, then the following minimum specifications shall have to be met :
  - i) In addition to the basic outstation, a minimum of two slots shall be provided for the insertion of plug-in function cards.
  - ii) The cards shall provide for analog or digital, input or output, hardwired connections to the installed plant.

- iii) The quantity and combination of these cards shall be determined by the requirements of the plant in that location with the concurrence of the ITPO.
- n. Each DDC's shall have minimum 20 % spare capacity (digital/analog input/output) to give flexibility for future expansion.
- o. All DDC controllers shall be capable of handling voltage, milli-ampere, resistance or open and closed contacts inputs in any mix, if required.

Analog inputs/outputs of the following minimum types shall be supported :

- i) 4-20 mA.
- ii) 0-2 Volt
- iii) 0-10 volts.
- vi) Resistance Signals (either PTC or NTC)

(PT 100, PT 1000, PT 3000, Balco 500, NI 1000, NTC 20K)

Digital input/output types shall be as under :

- i) Normally-open contacts.
- ii) Normally-closed contacts.

Modulating outputs shall be true proportional outputs and not floating control type.

- p. Controller's packaging shall be such that, complete installation and check out of field wiring can be done prior to the installation of electronic boards.
- q. All board terminations shall be made via plug-in connectors to facilitate trouble-shooting, repair and replacement. Joints in cables are not permitted.
- r. Controllers shall preferably be equipped with diagnostic LED indicators with atleast indication for Power up Test OK, and Bus Error.
- s. It shall be possible for the controllers to accept regulated uninterrupted power supply to maintain full operation of the controller functions (control, logging, monitoring and communications) in the event of a localized mains failure.
- t. There shall be the facility for accessing controller data information locally, via a portable plug-in keypad display or laptop which should be common type to all controllers and normally removed to prevent unauthorized tampering. Alternatively main controller shall have a keypad and graphical display integral

with its casing for local interrogation and adjustment. In either case, access to the system thus provided shall be restricted by passwords in the same way as at the main operator terminal.

- u. In case the Portable operator Terminals (POT)/Laptops are required to program the controllers, sockets shall be provided for same. Attachment of POT / Laptop shall not interrupt or disable normal panel operation or bus connection in any way.
- v. The controllers shall be housed in vandal proof boxes to protect them from tampering by any unauthorized personnel.
- w. It shall be possible to add new controllers to the system without taking any part of the system off-line.

## 1.2 DIRECT DIGITAL CONTROLLERS CAPABILITIES

- a. The Controllers shall have a self analysis feature and shall transmit any malfunction messages to the Control Station. For any failed chip the diagnostic tests, printout shall include identification of each and every chip on the board with the chip number/location and whether the chip "Passed" or "Failed" the diagnostic test. This is a desired requirement as it would facilitate troubleshooting and ensure the shortest possible down time of any failed controller. Controllers without such safety feature shall be provided with custom software diagnostic resident in the EEPROM.
- b. Operating system (O.S.) software for controllers shall be EEPROM resident.

Controllers shall have resident in its memory and available to the programs, a relevant library of algorithms, intrinsic control operators, arithmetic, logic and relational operators for implementation of control sequences.

- c. In the event of failure of communication between the controllers and/or Control Station terminal, alarms, reports and logs shall be stored at the controllers and transmitted to the terminal on restoration of communication.
- d. In the event of memory loss of a Controller, or the expiration of back-up power, on start-up of the unit the necessary data-base shall be downloaded automatically. Controllers requiring a manual intervention for the re-boot of software are not desired.
- e. Where information is required to be transmitted between controllers for the sharing of data such as outside air temperature, it shall be possible for global

points to be allocated such that information may be transmitted on change of incremental value as well as at specific time intervals.

- f. Controllers must be able to perform the following minimum energy management functions as a minimum.
  - i) Time & Event programs
  - ii) Holiday Scheduling
  - iii) Maximum and Distributed power demand
  - iv) Optimum start and stop program
  - v) Night purge
  - vi) Load reset
  - vi) Zero energy band
  - vii) Duty cycle
  - vi) Enthalpy analysis and control
  - vii) Run Time Totalization
  - viii) Sequencing and Optimization
  - ix) Exception scheduling

Detailed description of software features and operating sequence of all available energy management software shall be submitted for approval of ITPO.

- g. The DDC Controllers shall have Adaptive Control capability whereby the control software measures response time and adjusts control parameters accordingly to provide optimum control. The software shall allow self-tuning of the variable control loops (all or any of P, P+I, P+I+D) of the AHU's and chiller system so as to provide the most efficient and optimized controls at different load conditions. The energy management programs shall update their parameters based on past experience and current operating conditions.
- h. Alarm Lockout shall be provided to prevent nuisance alarms. On the initial startup of air handler and other mechanical equipment a "timed lockout"

period shall be assigned to analog points to allow them to reach a stable condition before activating an alarm comparison logic.

Tenderers shall indicate their proposed system alarm handling capability & features.

- i. Run time shall be accumulated based on the status of a digital input point. It shall be possible to total ON time as well as OFF time. Run time counts shall be resident in non-volatile memory.
- j. It shall be possible to accommodate Holiday and other planned exceptions to the normal time programs. Exception schedules shall be operator programmable up to one year in advance.
- k. Each DDC shall be capable of accepting & providing Modbus/Bacnet/lonwork input/ output wherever required. Any converter or interface device along with software required for receiving / providing these industries standard input / output shall be included in quoted price.

## 2. PORTABLE OPERATORS TERMINAL (POT)

- a. POT /Laptop shall be provided to allow operator readout of system variables, override control and adjustment of control parameters. The POT shall be portable and plug directly into individual controllers for power and data.
- b. The minimum functionality of POT shall include : Set points to a fixed value or state.
  - i. Display diagnostic results.
  - ii. Display sequentially all point summary and sequentially alarm summary.
  - iii. Display/change digital point state, analog point value.
  - iv. Display/change time and date.
  - v. Display/change analog limits.
  - vi. Display/change time schedule.
  - vii. Display/change run time counts and run time limits.
  - viii. Display/change time and/or event initiation.
  - ix. Display/change programmable offset values.
  - x. Access DDC initialization routines and diagnostics.

- xi. Enable/disable points, initiators and programs.
  - xii. Display/change minimum ON/OFF and maximum OFF times.
- 
- c. The POT shall be complete with command keys, data entry keys, cursor control keys and a 24 character liquid crystal alphanumeric display. Access shall be via self prompting menu selection with arrow key control of next menu/previous menu and step forward/backward within a given menu.
  - d. Connection of a POT to a controller shall not interrupt or interfere with normal network operation in any way, prevent alarms from being transmitted, or interfere with Control Station commands and system modifications.
  - e. Connection of POT at any controller shall provide display access to all controllers on that bus. In case the controller has a fixed LCD display and entry keyboard, then the display access shall be available on each screen.
  - f. It should be possible to override the commands given through POT by the Operator Control Station.

### 3. DATA COMMUNICATION

The communication between controllers shall be via a dedicated communication network as per manufacturer's standards. Controllers microprocessor failures shall not cause loss of communication of the remainder of any network. All networks shall support global application programs, without the presence of a host PC.

The communication network shall be such that:

- a. Every DDC must be capable of communicating with all DDC's.
- b. Network connected devices with no messages to transmit shall indicate "No failure" message each cycle. Lack of this message after successive retries shall constitute a communication or device failure.
- c. Each controller is to be provided with a communication watchdog to assure that an individual controller does not permanently occupy the bus. If a controller is detected as occupying more time than usual, then it shall be automatically shutdown and an alarm sent to the Control Station.
- d. Error recovery and communication initialization routines are to be resident in each network connected device.



- e. For reliability, maintainability, and performance, communication network shall be extendable to 4,000 feet without active links, hubs, or repeaters. The BMS Software shall be configured in a redundant HOT standby Mode for maximum availability and reliability
- f. The communication protocol shall incorporate CRC (Cyclic Redundancy Check) to detect transmission errors. Parity bit error checking shall not be acceptable.

Single or multiple stand alone controller failures shall not cause loss of communication between active control panels connected on the communication network. Full communication shall be sustained as long as there are at least two operational stand alone control panels active on the communication network.

All the System Integration Units shall be linked together on a Local Area Network.

The communication network shall include provision for automatically reconfiguring itself to allow all operational equipment to perform as efficiently as possible in the event of single or multiple failure.

#### 4. FIELD DEVICES

##### 4.1 *ELECTRIC AND ELECTRONIC CONTROLS RELATED EQUIPMENT*

###### ***General Requirements***

All controls shall be capable of operating in ambient conditions varying between 0-55 deg. C and 90% R.H. non-condensing and shall be supplied with adaptors for 25 mm conduit.

###### ***Ancillary Items***

When items of equipment are installed in the situations listed below. Following ancillary items shall be supplied by contractor and nothing extra shall be paid on this contract.

###### (i) Weather Protection

All devices required to be weatherproofed shall be as per manufacturer recommendation or as detailed in the Schedule of Quantities. IP ratings required for the equipment is mentioned in the respective section

- (ii) Pipework Immersion  
Corrosion resisting pockets of a length suitable for the complete active length of the device, screwed ½" (13 mm) or ¾" (20 mm) NPT suitable for the temperature, pressure and medium.
- (iii) Duct Mounting (Metal or Builders Work)  
Mounting flanges, clamping bushes, couplings, locknuts, gaskets, brackets, sealing glands and any special fittings necessitated by the device.

***Additional features***

- (i) Concealed Adjustment : All two position switching devices shall have concealed adjustment unless detailed otherwise in the Schedule of Quantities.
- (ii) Operating Voltage : All two position switching devices shall operate on 230 v a.c and all accessible live parts shall be shrouded. An earth terminal shall be provided as TNS earthing system and connected to MV & HV earth pits also.

**4.2 TEMPERATURE SENSOR**

Temperature sensors for space, pipes and ducts, shall be of the Resistance Temperature detector (RTD) type or thermistor. These shall be two wire type and shall conform to the following specifications

- a. Immersion sensors shall be high accuracy type with a high resistance versus temperature change. The accuracy shall be at least  $\pm 1$  degrees F.
- b. Immersion sensors shall be provided with separate stainless steel thermo well. These shall be manufactured from bar stock with hydrostatic pressure rating of at least 10 kgf/cm<sup>2</sup>.
- c. The connection to the pipe shall be screwed ¾ inch NPT (M). An aluminium sleeve shall be provided to ensure proper heat transfer from the well to the sensor. Terminations to be provided on the head. Flying leads shall not be acceptable.
- d. The sensor housing shall plug into the base so that the same can be easily removed without disturbing the wiring connections.
- e. Duct temperature sensors shall be with rigid stem and of averaging type. These shall be suitable for duct installation.
- f. Outdoor air temperature sensor shall be provided with a sun shield.
- g. The sensors shall not be mounted near any heat source such as windows, electrical appliances etc.

The temperature sensors may be of any of the following types :

- a. PT 100, PT 1000, PT 3000
- b. NI 100, NI 1000
- c. Balco 500.
- d. Thermistor
- e. NTC 20 K

#### 4.3 **HUMIDITY SENSOR**

Space and duct humidity sensors shall be of capacitance type with an effective sensing range of 10% to 100% RH. Accuracy shall be  $\pm 3\%$  or better. Duct mounted humidity sensors shall be provided with a sampling chamber. Wall mounted sensors shall be provided with a housing. The sensor housing shall plug into the base so that the same can be easily removed without disturbing the wiring connections. The sensors shall not be mounted near any heat source such as windows, electrical appliances etc.

#### 4.4 **FLOW METER**

Water flow meters shall be either sonic type or electromagnetic type. For electromagnetic flow meter, teflon lining with 316 SS electrodes must be provided. The housing shall have IP 55 protection. Vendors shall have to get their design/selection approved by the Consultant, prior to the supply.

The exact ranges to be set shall be determined by the contractor at the time of commissioning. It should be possible to 'zero' the flowmeter without any external instruments, with the overall accuracy of at least  $\pm 1\%$  full scale.

#### 4.5 **PRESSURE TRANSMITTER FOR WATER**

Pressure transmitters shall be piezo-electric type or diaphragm type. (Bourdon Tube type shall not be acceptable). Output shall be 4-20mA or 0-10V DC and the range as specified in the data sheet depending on the line pressure. Power supply shall be either 24 V AC, 24 V DC or 110 V AC. Connection shall be as per manufacturer's standards. The pressure detector shall be capable of withstanding a hydraulic test pressure of twice the working pressure. The set point shall fall within 40%-70% of the sensing range and detector shall have sensitivity such that change of 1.5% from the stabilized condition shall cause modulation of the corrective element. The sensor must be presume compensated for a medium temperature of  $-10^{\circ}\text{C}$  to  $60^{\circ}\text{C}$  with ambient ranging between  $0^{\circ}\text{C}$  to  $55^{\circ}\text{C}$ . Housing for these shall be weather proof with IP 65 protection.

#### 4.6 **DIFFERENTIAL PRESSURE SWITCH FOR PIPE WORK**

These shall be used to measure pressure differential across suction and discharge of pumps. The range shall be as specified in the data sheet. Switch shall be ON with increase in differential. Housing for these shall be weather proof with IP 55 protection.

The pressure switch shall be capable of withstanding a hydraulic test pressure of 1.5 times the working pressure. The set point shall fall in 40-70% of the scale range and shall have differentials adjustable over 10%-30% of the scale range. The switches shall be provided with site adjustable scale and with 1 NO/NC contact.

#### 4.7 **DIFFERENTIAL PRESSURE SWITCH FOR AIR SYSTEMS**

- a. These shall be diaphragm operated. Switches shall be supplied with air connections permitting their use as static or differential pressure switches.
- b. The switch shall be of differential pressure type complete with connecting tube and metal bends for connections to the duct. The housing shall be IP 54 rated. The pressure switches shall be available in minimum of 3 ranges suitable for applications like Air flow proving, dirty filter, etc. The set point shall be concealed type. The contact shall be SPDT type with 230 VAC, 1 A rating.
- c. The switch shall be supplied suitable for wall mounting on ducts in any plane. It should be mounted in such a way that the condensation flow out of the sensing tips. Proper adaptor shall be provided for the cables.
- d. The set point shall fall within 40%-70% of the scale range and I have differentials adjustable over 10%-30% of the scale range.
- e. The switches shall be provided with site adjustable scale and with NO/NC contact.

#### 4.8 **AIR FLOW SWITCHES**

Air flow switches shall be selected for the correct air velocity, duct size and mounting attitude. If any special atmospheric conditions are detailed in the Schedule of Quantity the parts of the switches shall be suitably coated or made to withstand such conditions. These shall be suitable for mounting in any plane. Output shall be 1 NO/NC potential free. Site adjustable scale shall also be provided.

**4.9 AIR PRESSURE SENSOR**

The pressure sensor shall be differential type. The construction shall be spring loaded diaphragm type. The movement of the membrane in relation to the pressure should be converted by an inductive coupling which would electromagnetically give an output suitable for the controller. The pressure sensor shall be in a housing having IP 54 ratings in accordance with IEC 529. Suitable mounting arrangement shall be available on the sensor. The sensor shall come complete with the PVC tubes & probes.

**4.10 WATER FLOW SWITCH**

These shall be paddle type and suitable for the type of liquid flowing in the line. Output shall be 1 NO/ 1NC potential free.

**4.11 TRANSDUCERS FOR ELECTRICAL SERVICES**

- a. Electrical transducers shall be integrated electronic type and rack mounted on the field. These shall work on 110V/ 220 V supply with the output being standard type i.e. 4-20 mA, 0- 10 Volts etc.
- b. Power factor, Voltage, Current, Frequency and Kilowatt transducers shall have standard output signal for measurement for the specified variable.
- c. Kilowatt-Hour metering(if any) shall be poly-phase, three- element with current transformer (CT) operated type. The metering shall feature high accuracy with no more than +/- 1% error over the expected load range. The coils shall be totally encapsulated against high impulse levels.

**4.12 LEVEL SWITCH**

The level switches shall have to meet the following requirement :

Type	:	Float Type/Capacitance type/Conductivity type
Mounting	:	To suit application
Connection	:	Flanged ANSI 150 lbs RF Carbon steel
Float material	:	316 SS
Stem Material	:	316 SS
Output	:	2 NO, 2 NC potential free
Switch Enclosure	:	IP 55

#### 4.13 TWO WAY ON/OFF BUTTERFLY VALVE

##### 4.13.1 Valve

- |    |                                |   |                         |
|----|--------------------------------|---|-------------------------|
| a. | Type of valve                  | : | Butterfly Valve.        |
| b. | Body Material                  | : | Carbon steel ASTM A 216 |
| c. | Body seat ring (if applicable) | : | Gr WCB                  |
| d. | Vane                           | : | SS-316                  |
| e. | Packing                        | : | Teflon                  |
| f. | Mounting Stool                 | : | Required.               |
| g. | Shaft                          | : | SS-316                  |
| h. | Seat                           | : | Nitrile rubber          |
| i  | Fasteners                      | : | SS-316                  |
| J  | Leakage                        | : | With 100 % Leak proof   |

##### 4.13.2 Actuators

- |                        |   |  |
|------------------------|---|--|
| Type                   | : | Electric                               |
| Duty.                  | : | On/Off (Maximum 50 operations per day) |
| Motor power supply     | : | 230 V AC or 415 V 3-phase              |
| Travel limit switches  | : | 2 Nos                                  |
| Torque limit switches. | : | 2 Nos                                  |
| Hand wheel             | : | Required                               |
| Speed                  | : | Approx 150 mm/min                      |

Note:

- a. Actuator must open/ close with one changeover contact. Control panel, if required, must be supplied integral with the Actuator.
- b. No gear box is envisaged, however if gear box is provided, the travel limit switches must be connected directly to the valve stem.
- c. Cover tube for the valve stem must be provided.

#### 4.13.3 CURRENT RELAY

Current relay are solid state switches that operate when the AC current level sensed by the Internal current transformer exceeds a fixed or adjustable trip points. The relay shall be of solid or Split core.

Switch Type Normally open solid state

Switch Rating 1- 135 VAC/VDC

Response Time less than 150 Sec.

Operating Temp -40 to 50 deg C

#### 4.13.4 INDOOR AIR QUALITY SENSOR

CO<sup>2</sup> Sensors ( Indoor Air Quality Sensor ) Duct mounted/Wall mounted

The sensor should measure and transmit CO<sub>2</sub> level ranging from 0 to 2000 parts per million(ppm) from return air path. These shall work on 24 vac or 24 vdc supply with the output being standard type i.e. 4-20 mA, 0- 10 Volts etc.

Output signal : 4 mA to 20 mA or 0 to 10 vdc

Operating Temperature Range : 23 to 113 deg F or -5 to 45 deg C

Operating Humidity Range : 0 to 85% non condensing

Air Flow Range : 0 to 7500ft / min

Power Supply : 24 VAC or 24VDC

-0-0-0-



### Section 3

#### CONTROL WIRING

##### **1.0 ENCLOSURES FOR CONTROLLERS AND ELECTRICAL PANELS**

- a. All the controllers shall be housed in pad lockable Vandal proof boxes which shall either be floor mounted or wall mounted. These shall be free standing, totally enclosed, dust and vermin proof and suitable for tropical climatic conditions.
- b. The panel shall be metal enclosed 14 SWG CRCA sheet steel cubicle with gaskets between all adjacent units and beneath all covers to render the joints dust proof. All doors and covers shall be hinged and latched and shall be folded and braced as necessary to provide a rigid support. Joints of any kind in sheet metal shall be seam welded with welding slag grounded off and welding pits wiped smooth with plumber metal.
- c. All panels and covers shall be properly fitted and secured with the frame and holes in the panels correctly positioned. Fixing screws shall enter into holes tapped into an adequate thickness of metal or provided with nuts. Self-threading screws shall not be used in the construction of control panels. Knockout holes of approved size and number shall be provided in the panels in conformity with the location of incoming and outgoing conduits/cables. Lamps shall be provided to support the weight of the cables. The dimension of the boxes shall depend on the requirement with the colour decided in consultation with the ITPO.

Note : Panel enclosures for indoor application shall have IP 42 protection and IP 65 protection for outdoor application.

##### **2. CONDUITS AND WIRING**

###### **2.1 Refer Electrical Specification Section**

###### **2.2 MODE OF MEASUREMENT**

###### Signal Cable

The cabling running between DDC controller to the field devices shall be termed as signal cabling. This cabling along with conduits shall be payable on I/O points basis.

Communication Cable

The cabling running between the system integration units to the DDC controllers shall be defined as communication cable. This cable along with conduits shall also be measured on unit length.

LAN Cable

The cable connecting various system integration units to the control station shall be termed as LAN cable. This cable along with conduits shall be measurable on unit length basis.

3. SIGNAL CABLING & COMMUNICATION CABLING

The signal cable shall be of the following specifications :

- a. Wire : Annealed Tinned Copper
- b. Size : 1.5 sq. mm for communication & 1.0 Sqmm for Signal
- c. No. of conductors : Two (One pair)
- d. Shielding : Overall beld foil Aluminium polyster shield.
- e. Jacket : PVC
- f. Nominal DCR : 17.6 ohm/km for conductor  
57.0 ohm/km for shield
- g. Nominal OD : 8.5 mm
- h. Nominal capacitance : 130 pF/m between conductors  
at 1 KHz 180 pF/m between one conductor and other  
conductors connected to shield.
- j. Colour : Black and Red

3.1 LOCAL AREA NETWORK CABLE

Depending on the type of LAN system being used by the contractor, standard, manufacturer’s specification shall apply.

#### 4. ELECTRONIC METERING

- i. Digital Electronic metering as provided on the main Electrical panels. Networking of the meters shall be in scope of BMS work.
- ii. The electronic meter shall have RS-485 connectivity and it shall be BMS vendor responsibility to develop all necessary interface for downloading data in the BMS platform.
- iii. All the instantaneous measurements shall be displayed on the BMS control station and the data shall be logged. It shall be possible to access minimum / maximum logging of any parameter with alarm annunciation for unusual measurements. The system shall also accept user defined "Set-Point" limit of any parameter.

#### 5. BTU METERING SYSTEM

- i. The BMS is required to meter the air-conditioning capacity utilized by the various tenant occupied areas. The air-conditioning capacity (KW or TR) shall be computed by measuring the flow rate of chilled water and the temperature in the flow and return pipes from each space.
- ii. The flow measurement shall be carried out by an ultrasonic flow meter and relayed to the BAS. The measurement device shall be create a pressure loss of more than 0.02 bar (the signal may be larger as long as part of it is recovered). The contractor shall suitably locate the measurement device and if required allow for locally increasing / decreasing pipe sizes to achieve velocities for accurate measurement. All electrical connections etc. shall be enclosed in weather proof boxes. The pressure rating of the measurement device shall be PN10 minimum.
- iii. The system shall calculate the air-conditioning capacity (in KW) being consumed by each Tenant and a time integral function shall allow the calculation of (kW - hours) of air-conditioning in order to establish proportionate costs. The software shall allow generation of graphs using the above data.
- iv. This air conditioning energy metering system shall comprise of the following components:
  - a. BTU Meters with Ultrasonic flow meters, header temperature sensing and local displays
  - b. Metering bus interfaces

- c. Central Metering Bus interface for furnishing open protocol i.e. Modbus / Lon works / BACnet.
- d. The BTU meter shall monitor energy consumption in a circulating water loop by calculating the temperature difference between two temperature sensors and rate of flow from a flow sensor. Two temperature sensors (thermistors) shall be provided in supply and return pipe. Flow Sensor shall be used for monitoring and recording water consumption. The readings of the two temperature sensors and the Ultrasonic flow sensor shall be given to the BTU meter system for recording the energy. It shall be integrated to the through standard open protocol industrial bus connectivity, thereby bringing all the parameters into the BAS.

**6. TESTING**

- a. The installed system shall be tested as for operation and performance. The results for these shall be in quadruplicate for scrutiny.
- b. For every analog input point tested, the system shall simulate value of input, independent of the actual field condition. This shall be accomplished either through software or a discrete field mounted potentiometer for each analog input.
- c. For every digital input point tested, the system shall simulate either an open or closed status, independent of the actual field condition. This shall be accomplished either through software or a discrete field mounted input switch for each digital input.
- d. Handover acceptance procedures shall include but not be restricted to the following:
  - 1. Display and printout of all points
  - 2. Verification for control for all output points
  - 3. Concurrent point history of all points
  - 4. Display of all graphic screens including historical and Real time graphs for all analog points.
  - 5. Validation of control actions.
  - 6. Comprehensive setting to work and tuning of control routines e.g optimizing proportional bands and control action etc.

**7. TRAINING:**

Contractor shall provide training to ITPO officials for BMS system.

-O-O-O-

Section 4

TECHNICAL DATA SUBMITTAL

A. CENTRAL CONTROL STATION EQUIPMENT

1. CENTRAL PROCESSING UNIT

- a. Manufacturer :
- b. Country of Origin :
- c. Local Agent :
- d. Model :
- e. Processor :
- f. Minimum ROM (K Bytes) :
- g. RAM Capacity Installed :
- h. Ram Capacity Expandable :
- i. Hard Disk Capacity (M Bytes) :
- j. Floppy Disk Drive Capacity (M Bytes) :
- k. Dimension Overall (mm) :

2. COLOUR GRAPHIC MONITOR

- a. Manufacturer :
- b. Country of Origin :
- c. Local Agent :
- d. Type :
- e. Model :
- f. Screen Size :
- g. Resolution :
- h. Colours :

3. KEYBOARD

- a. Manufacturer :
- b. Country of Origin :

- c. Local Agent :
- d. Type :
- e. Model :
- f. No. of Keys :

4. *MOUSE*

- a. Manufacturer :
- b. Country of Origin :
- c. Local Agent :
- d. Type :
- e. Model :

5. *REPORT PRINTER*

- a. Manufacturer :
- b. Country of Origin :
- c. Local Agent :
- d. Type :
- e. Model :
- f. Print Speed :
- g. Number of Columns :
- h. Paper Feed :

B. SENSORS CONTROLLERS, SENSORS & TRANSDUCERS

1. DDC CONTROLLER

- a. Manufacturer :
- b. Country of Origin :
- c. Local Agent :
- d. Model :
- e. Micro Processor Model :
- f. No. of Bits :
- g. RAM Memory :
- h. RAM Backup Battery :
- j. Battery Backup (Hrs) :
- k. Transmission Rate :
- l. Peer Communication :
- m. Alphanumeric LCD Display :
- n. Enclosure Dimensions (mm) :
- o. Weight (Kg) :
- p. Power Supply :

2. SYSTEM INTEGRATION UNITS

- a. Manufacturer :
- b. Country of Origin :
- c. Model :
- d. Micro Processor Model :
- e. No. of Bits :
- f. RAM Memory :
- g. RAM Backup Battery :
- h. Battery Backup (Hrs) :
- i. Transmission Rate :
- j. Peer Communication :
- k. Alphanumeric LCD Display :
- l. Enclosure Dimensions :
- m. Weight (Kg) :
- n. Power Supply :

3. IMMERSION / DUCT TEMPERATURE SENSOR

- a. Manufacturer :
- b. Country of Origin :
- c. Type :
- d. Model :
- e. Accuracy :
- f. Sensor Material :
- g. Temperature Coefficient :
- h. Sensing Range :
- i. Accessories :
- j. Degree of protection (IP) :

4. OUTSIDE TEMPERATURE SENSOR

- a. Manufacturer :
- b. Country of Origin :
- c. Type :
- d. Model :
- e. Accuracy :
- f. Sensor Material :
- g. Temperature Coefficient :
- h. Sensing Range :
- i. Accessories :
- j. Degree of protection (IP) :

5. RELATIVE HUMIDITY SENSOR

- a. Manufacturer :
- b. Country of Origin :
- c. Type :
- d. Model :
- e. Sensing Range :
- f. Output Signal :
- g. Accuracy :



- h. Power Supply :
- i. Dimensions (mm) :
- j. Weight (Kg) :
- k. Degree of Protection (IP) :

6. *PRESSURE TRANSMITTER*

- a. Manufacturer :
- b. Country of Origin :
- c. Model :
- d. Pressure Sensing Element :
- e. Range :
- f. Monitoring :
- g. Enclosure :
- h. Supply Voltage :
- i. Output Signal :
- j. Degree of Protection (IP) :

7.0 *WATER FLOW SWITCHES*

- a. Manufacturer :
- b. Country of Origin :
- c. Type :
- d. Model :
- e. No. of Contacts :
- f. Type of Contacts :
- g. Connections :
- h. Power Supply :
- i. Degree of Protection (IP) :

8.0 *DIFFERENTIAL PRESSURE SWITCHES FOR PUMPS / BLOWER*

- a. Manufacturer :
- b. Country of Origin :
- c. Type :
- d. Model :
- e. Construction Material :

- f. Dimensions (mm) :
- g. Sensing Range :
- h. Max. Static Pressure on one side :
- i. No. of Contacts :
- j. Type of Contacts :
- k. Power Supply :
- l. Degree of Protection (IP) :

#### **9.0 FLOW METERS**

- a. Manufacturer :
- b. Country of Origin :
- c. Type :
- d. Model :
- e. Dimensions (mm) :
- f. Output Signal :
- g. Accuracy :
- h. Mounting Arrangement :
- i. Type of Flow Measuring Element :
- j. Operating Voltage :
- k. Degree of Protection (IP) :

#### **10.0 LEVEL SWITCHES**

- a. Manufacturer :
- b. Country of Origin :
- c. Type :
- d. Model :
- e. Dimensions (mm) :
- f. Mounting :
- g. Type of Switch :
- h. Type of Contacts :
- i. No. of Contacts :
- j. Power Supply :
- k. Degree of Protection (IP) :

11.0 *CURRENT / VOLTAGE / KWH TRANSDUCER*

- a. Manufacturer :
- b. Country of Origin :
- c. Type :
- d. Model :
- e. Operating Voltage :
- f. Type of Signal :
- g. Response Time :
- h. Range :
- i. Power Supply :
- j. Mounting :

C. *CABLES*

1. *SIGNAL CABLES*

- a. Manufacturer :
- b. Country of origin :
- c. Type :
- e. Characteristics :

*COMMUNICATION CABLES*

- a. Manufacturer
- b. Country of origin :
- c. Type :
- d. Characteristics :

-0-0-0-

Section 5

TEST AT SITE

1. General

The contractor must perform all inspection and tests of the system as a whole and of components individually as required, under the supervision of the Owner/Consultant, in accordance with the provisions of the applicable ASHRAE standards or approved equal and furnish necessary test certificates from manufacturers.

2. Controls

2.1 Valves:

Hid. /pneumatic test certificates.

2.2 Instruments and controls

Visual examination.

3. For associated works at site.

3.1 All electrical items will be subjected to inspection at any stage during manufacturing activity. Routine electrical test as per relevant codes. Inspection of manufacturer's test certificates.

3.2 Inspection of controller panels and its devices.

3.3 Checking of electrical control circuits and checking functioning of HVAC System and other circuits where applicable.

3.4 Checking of calibration of controls and instrumentation

3.5 Checking of assemblies for instruments panels, enunciator panels, etc.

3.6 Inspection of complete installation at site.

3.7 Function testing of all systems as per specifications.

4. The above inspection procedure is given for general Guidance and information of vendors and inspection of Owner/Consultant is strictly not limited to these and Inspection Engineer of Owner/Consultant will have full right to have detailed inspection at any stage right from placement of order to completion of project as desired by Inspection Engineer, co-ordination of inspection agency of Owner/Consultant with his factory/sub-vendor's factory/erection site will be the sole responsibility of successful vendor after placement of order for complete Air Conditioning plant covered under these technical specifications.

5. Electrical equipment:

5.1 All electrical equipment shall be cleaned and adjusted on site before application of power.

- 5.2 The following tests shall be carried out:
  - 5.2.1 Wire and cable continuity tests.
  - 5.3 Insulation resistance tests, on all circuits and equipment, using a 500 volt mega. The meggar reading shall be not less than one megaohm.
  - 5.4 Earth resistance between conduit system and earth must Not exceed half (1/2) Ohm.
  - 5.5 Operating tests on all protective relays to prove their Correct operation before energizing the main equipment.
  - 5.6 Operating tests on all circuit etc.
- 6. Performance tests:
  - 6.1 The installation as a whole shall be balanced and Tested upon completion, and all relevant information, including the following shall be submitted to the consultants.
    - 6.1.1 Differential pressure readings across each filter, fan and coil, and through each pump.
    - 6.1.2 Continuous recording over a specified period, of Ambient wet and dry bulb temperatures under varying degrees of internal heat loads and use and occupation, in each zone of each part of the building.
  - 6.2 Daily records should be maintained of hourly readings, taken under varying degrees of internal heat load and use and occupation, of wet and dry bulb temperatures, upstream “on-coil” of each cooling coil. Also suction temperatures and pressures for each refrigerating unit. The current and voltage drawn by each machine.
  - 6.3 Any other readings shall be taken which the Owner/Consultant may Subsequently specify.
- 7. Miscellaneous:
  - 7.1 The above tests are mentioned herein for general Guidance and information only but not by way of limitation to the provisions of conditions of contract and specification.
  - 7.2 The date of commencement of all tests listed above shall be subject to the approval of the Owner/Consultant, and in accordance with the requirements of this specification.
  - 7.3 The contractor shall supply the skilled staff and all necessary instruments and carry out any test of any kind on a piece of equipment, apparatus, part of system or on a complete system if the Owner/Consultant requests such a test for determining specified or guaranteed data as given in the specification or on the drawings.
  - 7.4 Any damage resulting from the tests shall be repaired and/or damaged material replaced, all for the satisfaction of the Owner/Consultant.
  - 7.5 In the event of any repair or any adjustment having to be made, other than normal running adjustment, the tests shall be void and shall be recommended after the adjustment or repairs have been completed.

- 7.6 The contractor must inform the Owner/Consultant when such tests are to be made, giving sufficient notice, in order that the Owner/Consultant or his nominated representative may be present.
- 7.7 Complete records of all tests must be kept and 3 copies of these and location drawings must be furnished to the Owner/Consultant.
- 7.8 The contractor may be required to repeat the test as required, should the ambient conditions at the time not given, in the opinion of the Owner/Consultant, sufficient and suitable indication of the effect and performance of the installation as a whole or of any part, as required.

**NOTE:** All the codes and compliances irrespective of what is mention, shall be the codes and compliances as applicable in Osaka, Japan.

**Makes:** If the makes of the material mentioned herein are not available then the contractor may propose the equivalent product of the “make”/manufacturers which is available in Japan fulfilling the local laws and compliances suitable the functions for which is meant and decisions of Engineer in Charge/ ITPO shall be final.

**Note:** The Code given are indicative however the contractor before procuring & executing the work shall ascertain & determine the applicable Japanese codes, which are required to be complied with Osaka Japan, and only there after the respective material should be used.

-O-O-O-

## TECHNICAL specifications (HORTICULTURE)

### 9 Chapter I

#### 9.1 SPECIAL CONDITIONS

Work under this contract shall be executed as shown on the drawings and given in the specifications and required at site whether specifically shown or not.

#### 9.2 Scope of work

Work under this contract shall consist of furnishing all labour, materials, equipment and appliances necessary and required to completely do all work relating to horticulture works described herein after and shown on the drawings.

#### 9.3 Specifications

1. Work shall be carried out strictly in accordance with the specifications attached to this tender
2. Works not covered in the specifications shall be carried out as per relevant Japanese Standards Code of Practice and specifications of materials.

#### 9.4 Execution of work

1. The work shall be carried out in conformity with the contract drawings and within the requirements of Architectural, HVAC, Plumbing, Electrical, Structural and other specialized services drawings
2. The contractor shall co-operate with all trades and agencies working on the site.
3. On award of the work the contractor shall submit a schedule of work in the form of a PERT chart or Bar chart for approval of the LANDSCAPE ARCHITECTS/CLIENTS. All dates and time schedules agreed upon shall be strictly adhered to.
4. The contractor shall provide all facilities to LANDSCAPE ARCHITECT or his authorized representative to make frequent inspection of their nursery and as certain the progress/quality of various categories of plants grown by them.
5. The safe custody and up-keep of various categories of plants brought to the site is the sole responsibility of the Contractor and he shall employ sufficient supervisory personnel to ensure the safety of these items.
6. The site of work may be handed over to the Contractor for start of work in phases, as soon as the same are available and the Contractor in turn shall start work in these areas forth with. Nothing extra shall be payable for such phased execution of work.
7. While excavating/executing the work, the Contractor shall ensure that existing cable/pipelines/structures/fittings are not damaged and if due to negligence, these are damaged the same shall be set right with no extra cost to the Client.
8. The Contractor shall keep the site of works neat and clean during the execution of the work. Any debris founds at or near the site of work shall be got removed immediately as and when so required by the LANDSCAPE ARCHITECT/Project Engineer.
9. The contractor shall co-ordinate his work with other agencies employed by the Clients and ensured that the work of other agencies is not hampered in any way during the execution of the contract.

10. On completion of the work, the site of works shall be thoroughly cleaned and all debris removed before the work is handed over satisfactorily.
11. The Contractor shall, without any additional charge to the Client, renew or replace any dead or defective plants/grass and shall fully maintain the whole landscape for a period of twelve months after the certified date of completion.

## 9.5 Drawings

1. Contract drawings are diagrammatic but shall be followed as closely as actual construction permits. Any deviation made shall be in conformity with the architectural and other services drawing.
2. Landscape Architectural drawings shall taken precedence over plumbing or other services drawings as to all dimensions
3. Contractor shall verify all dimensions at site and bring to the notice of the LANDSCAPE ARCHITECTS or Engineer-in-charge any or all discrepancy or deviations noticed. LANDSCAPE ARCHITECTS decision shall be final.
4. Any drawing supplied with the tender shall be returned in good conditions along with the tender.
5. All drawings issued by the LANDSCAPE ARCHITECTS for the work are the property of the LANDSCAPE ARCHITECTS and shall not be copied, reproduced or used on any other works than intend without the written permission of the ARCHITECTS.

## 9.6 Materials

1. All plant materials used on this work shall conform to the specifications and as laid down in schedule III A.
2. All materials used on the project shall be approved by the Engineer-in-charge/LANDSCAPE ARCHITECTS before use.
3. Contractor may be required to purchase such plant materials of particular kind or form a particular source if in the opinion of Engineer-in-charge/LANDSCAPE ARCHITECT the same is necessary and required for the proper and reasonable compliance of the specifications and in the interest of better quality of work.

## 9.7 Reference Drawings

1. The contractor shall maintain one set of all drawings issued to him as reference drawings. These shall not be used on site.
2. All corrections, deviations, and changes made on the site shall be shown on these reference drawings for final incorporations in the completion drawings. All changes so made shall be initialed by the Engineer-in-charge or LANDSCAPE ARCHITECTS.

## 9.8 Site Order Book

1. The contractor shall maintain a site order book at the site office.
2. All instructions relating to the job shall be recorded by the Engineer-in-charge or LANDSCAPE ARCHITECTS along with contractors compliance.
3. Contractor is bound to carry out all such instruction given to him.



### 9.9 Contractor's Rates.

1. Rates quoted in this tender shall be inclusive of cost of materials, labour, supervision, erection, tools, plant, scaffolding services, transport to site, taxes, breakage, wastage, maintenance and all such expenses as may be necessary and required to completely do all the items of working and put them in a working condition.

### 9.10 Alterations in Specification and Designs

1. Derivation of rates of Extra and substitute items.
2. The LANDSCAPE ARCHITECTS shall have power to make any alterations in, omission from, additions to or substitutions for, the original specifications, drawings design, and instructions that may appear to him to be necessary during the progress of the work, and the contractor shall carry out the work in accordance with any instructions which may be given to him in writing signed by the LANDSCAPE ARCHITECT or his authorized Engineer and such alterations omissions, additions or substitutions shall not invalidate the contract. Any alteration/addition or substitution work which the Contractor may be directed to do in the manner above specified as part of the work shall be carried out by the Contractor on the same conditions in all respects on which he agreed to do the main work. The time for the completion of the work shall be extended in the proportion that the altered, additional, or substituted work bears to the original contract work and the certificate of the LANDSCAPE ARCHITECT shall be conclusive as to such proportion. The rates for such additional, altered or substituted work under this clause shall be worked out in accordance with the following provisions in their respective order.
3. If the rates for the additional, altered or substituted work are specified in the contract for the work, the contractor is bound to carry out the additional, altered for substitute work at the same rates as are specified in the contract for the work.
4. If the rates for the additional, altered or substituted work are not specifically provided in the contract for the work, the rates will be derived from the rates for a similar class of work as are specified in the contract for the work.
5. If the altered, additional or substituted work includes any work for which no rate is specified in the contract for the work or cannot be derived from the similar class of work in the contract, then such work shall be carried out at the rates entered in C.P.W.D. Delhi Schedule, (latest) minus/plus percentage which the total tendered amount bears to the estimated cost of the entire work put to tender.
6. If the rates for the altered, additional or substituted work cannot be determined in the manner specified in sub-clause (1) to (3) above, then the rates for such work shall be worked out on the basis of the schedule of rates specified above minus/plus the percentage which the total tendered amount bears to the estimated cost of the entire

work put to tender. Provided always that if the rate for a particular part or parts is not in the schedule of rates, the rate for such parts will be determined by the LANDSCAPE ARCHITECT on the basis of the prevailing market rates when the work was done.

7. If the rates for the altered, additional or substituted work cannot be determined in the manner specified in the sub-clause (1) to (4) above then the contractor shall within 7 days from the date of receipt of order, to carry out the work, shall inform the PROJECT-IN-CHARGE. The rates at which he would be willing to carry out such class of work duly supported by analysis of the rate or rates which he claims, and the PROJECT-IN-CHARGE shall determine the rate or rates on the basis of prevailing market rates and pay the contractor accordingly. However, the LANDSCAPE ARCHITECT by notice in writing, will be at liberty to cancel his order to carry out in such manner as he may consider advisable. But under no circumstances. The contractor shall suspend the work on the plea of non-settlement of rates of items, falling under the clause. The contractor shall be allowed 15% profit on market rates.
8. Water shall be made available free of cost at one point within the project site. Contractor shall make his own arrangements for drawing water from there.
9. If electricity is required for the works, the contractor would be required to make his own arrangements for electricity, free of cost.
10. Contractor's quoted rates shall include execution of these works at all levels and nothing extra shall be paid for any item for working at different heights.

## 9.11 specifications FOR HORTICULTURAL WORKS

### SCOPE OF WORK

1. The Planting Contractor shall provide all horticultural operations and services specified on the drawing schedule of quantities as specified herein or both, including:
2. Provide labour, equipment, services and transport.
3. Provide all plant material
4. Provide topsoil for all plants.
5. Provide fertilizers, chemicals and manure and stakes as specified.
6. Preparation of planting locations.
7. Prepare plants pits, back filling, prepare "saucers" for watering, adding soil after settlement.
8. Spraying before planting.
9. Staking, supporting, wrapping and tying plant materials.
10. Transplanting, if any
11. Disposal of debris and unused materials.
12. Guarantee of trees and plants for a period of twelve months.
13. Free Visiting, inspecting and consulting for the period of twelve months.

### 9.12 PLANT MATERIALS/LAWNS

1. Area - all exterior ground area, except surfaces occupied by structures and paving as well as areas indicated to be undisturbed or planted (trees, shrubs, ground covers, creepers, vines, annual plants, etc.), shall be planted as shown on drawing.

### 9.13 Materials

1. Top soil shall be fertile, friable, natural topsoil typical of locality, and shall be obtained from a well-drained site that is free of flooding. It shall be without admixture of subsoil or slag and shall be free of stones, lumps, plants or their roots, sticks and other extraneous matter and shall not be delivered or used while in a frozen or muddy condition.
2. Top soil as delivered to the site shall have an acidity range of PH 6.5 to 7.5 and shall not contain less than 5% organic matter. Sufficient Limestone shall be added to topsoil to bring it to a range of PH 6.5 to 7.5.

### 9.14 Ground Preparation

1. Grading - Grade lawn areas to finish grades, filling as needed or removing surplus dirt and floating areas to a smooth, uniform grade as indicated. All lawn areas shall slope to drain. Where no grades are shown, areas shall have a smooth and continual grade between existing contours (such as walks, curbs, catch basins, elevation at steps or building) and elevation shown on plans. Roll, scarify, rake and level as necessary to obtain true, even lawn surfaces, all finish grades shall meet approval of the LANDSCAPE ARCHITECT or his authorized representative, before lawn is laid.
2. Chemical fertilizer shall be spread on areas to be seeded at the rate of 20 lbs. per 100 square feet to fertilizer shall be 50% organic and shall be applied from a suitable spreader.
3. Natural fertilizer-Manure shall be well-unleached, Okhla khad or cattle manure free from sawdust shavings, refuse and harmful chemicals, manure shall contain no lumps which will not pass a 2 inch sieve. Spreading of 1-inch thick layer of manure on the ground and mixing with the good earth.
4. After incorporation of fertilizer in the soil, the lawn bed, shall be fine graded to remove all ridges and depressions, and surface cleared of all stones 1 inch or more in diameter and of other debris. At least 1-inch layer of manure to be spread on the ground and mix with earth for grassing. Ref. given specification for lawn bed preparation.
5. Planting of rooted cuttings grass at a regular distance of 5cm centre to centre. After 15 days 1st mowing should be done

or

Laying grass carpet directly on prepared ground.

### 9.15 Lawn Maintenance

1. Maintenance shall consist of watering, weeding, fertilizing, liming, disease and pest control, aerating, protective spraying, replacement of unacceptable material and any other procedure consistent with good horticulture practice necessary to ensure normal, vigorous and healthy growth of all planted area.
2. For the first 30 days, it requires approximately 500 gallons of water for every 100 square feet every day for each application to penetrate the soil to a depth of 4 to 6 inches. After the, same quantity of water shall be applied on alternate dates.
3. Keep all planting areas free from weeds and undesirable grasses.
4. Mow all grass areas at regular intervals which will keep grass height from exceeding 2.5 inches. Remove all grass clippings during or immediately after mowing.
5. Make periodic tests during the maintenance period to determine the degree of compaction existing in all lawn areas. If soil is compacted to a degree that water and air penetration is impaired, the Contractor shall aerate these areas to the satisfaction of the LANDSCAPE ARCHITECT.
6. Maintenance shall also include all temporary protection fences, barriers and signs and all other work incidentally to proper maintenance.
7. Upon completion and inspection of all repairs or renewals necessary in the judgment of the LANDSCAPE ARCHITECT, the LANDSCAPE ARCHITECT shall certify in writing to the clients.

### 9.16 PLANT MATERIAL-TREES, SHRUBS, GROUND COVERS, CREEPERS, VINES, ETC.

1. Plant List - Plants are listed in the drawings, the plant list is enclosed herein.
2. Nomenclature - The names of the plants confirm to standardized botanical names.
3. Quality and General Requirements of Plants.
  - I. Plants shall be typical of their species and variety, have normal growth habits, well developed branches, densely foliated with vigorous and fibrous root systems.
  - II. Plants shall be free from defects and injuries Bark shall be free from abrasion.
  - III. Plants shall be freshly dug and nursery grown. Plants shall have been grown under climatic conditions similar to those in locality of project, or have been acclimated for at least 2 years to conditions of project location. Nursery grown plants shall have been at least once transplanted.
  - IV. Each bundle of plants an all separate plants shall be properly identified by weather-proof labels securely attached there to before delivery to project site.
  - V. No. of plants shall be delivered to the project site, except for required samples, until inspection has been made in the field or at the nursery, or unless specifically authorized in writing by the LANDSCAPE ARCHITECT.
  - VI. B & B (Balled and Burlap) plants must be moved with the root system as solid units in balls of each firmly wrapped with burlap, The diameter and depth of the balls of

earth must be sufficient to encompass the fibrous and feeding root system necessary for the healthy development of the plant. No plant shall be used when the ball of earth surrounding its roots have been badly cracked or broken preparatory to or during the process of planting or after the equipment required in connection with its transplanting has been removed. The plant and ball shall remain intact as one unit during all operations.

- VII. Container grown stock shall have been grown in container long enough for the root system to have developed sufficiently to hold its soil together, firm and whole. No plant shall be loose in container.
- VIII. All plants shall be hardy under climatic conditions similar to those in the locality of the project. When plants of kinds or sizes specified are not available substitution may be made upon request by the Contractor if approved by the LANDSCAPE ARCHITECT.
- IX. All trees, soon after planting shall be properly supported to ensure their safety against wind or other factory which may effect it adversely. A minimum of 3 stakes per tree shall be provided by the contractor.

#### 9.17 Size of Plants

1. All plant shall be equal to or exceed the sizes given in the plant list, which are minimum acceptable sizes. Plants shall be measured before planting, with branches in normal position.
2. Trees shall be minimum length as specified and shall be straight and symmetrical with a crown and having a persistent main stem. The size of the crown shall be in good overall proportion to the height of the tree shall be measured from the top of the root ball or pot. In case of palms, ht. will be measured from top of root bell to the point of branching of leaves.
3. Shrubs shall be well formed with a crown typical of the species and variety. Shrub height dimension shall be the average height of the all stems and not of longest stem.
4. Ground cover plants shall be least one year old and shall be supplied in 8 inch earthen or other suitable posts.
5. Creepers and vines shall have at least 4 runners, and shall be supplied in 8 inch earthen or other suitable posts.

#### 9.18 TOP SOIL MIXTURE

1. Soil - Topsoil shall be friable foam material, fertile, typical or the cultivated topsoils of the locality, containing at least 2% of decay organic matter. Topsoil shall be taken from a well-drained arable site, shall be reasonably free of subsoil, stones, weeds, earth, clods, sticks, roots or other objectionable extraneous matter or debris and shall contain no toxic materials.

2. Representative samples shall be tested for fertility and general texture by the Contractor or by a recognized commercial or government agency. No topsoil shall be delivered in frozen or muddy condition.
3. Manure - Shall be well-rooted unleached ('Okhla Khad) free of harmful chemicals and other substances which may effect plan life. Manure shall be free of weeds, straw leaves or inorganic debris. It shall not be less than 8 months and more than 24 months old.
4. Sand - Coarse and taken from a dry river or sandy area shall be well washed and leached, and shall not contain any toxic chemical harmful to plants. Sand must be free of cobbles, stones, earth, roots, weeds and other foreign material. Sand will be incorporated and mixed with topsoil.
5. Compost Mixture - The ratio of the mixture of the topsoil to manure shall be :
  - i. 70% topsoil
  - ii. 30% manure
6. Fertilizer shall be complete fertilizer consisting of nitrogen, phosphorous and potash. It shall be applied by weight in two applications. The first application shall be within one week before planting at the rate of 35 lbs. per 100 square feet harrowed into the top 6 inches of soil. The second application shall be done, as the LANDSCAPE ARCHITECT will think is needed at the rate of 16 lbs. per 100 square feet.

#### 9.19 PLANTING OPERATIONS

1. Time of planting - Planting operations shall be conducted under favorable weather conditions, the Contractor will be notified by the LANDSCAPE ARCHITECT's representative when areas of work are sufficiently clear of construction work for the Contractor to commence work on planting.
2. Planting shall be done by experienced workmen familiar with planting procedures under the supervision of a qualified foreman.
3. Plants Pits shall be excavated with vertical sides, except for those designation to be planted in beds. Plant pits shall be of the following sizes.
  - a. Trees - 0.9m dia, 0.9m depth. min. for small trees, for large trees as specified in tender, tree pits shall be large enough to accommodate the root ball + 1/3 root depth on all sides.
  - b. Large Shrubs and climbers - 0.6m dia and 0.6m depth.
  - c. Medium & small shrubs bed - 0.45m depth of bed and in case of individual shrubs, 0.45 dia and 0.45 depth.
  - d. Ground Cover bed - The bed shall be dug a depth of 30 cms,
  - e. LANDSCAPE ARCHITECT shall inspect and approve plant pits before the contractor proceeds with placing of plants.
  - f. Topsoil shall be made ready for planting before plants are delivered to the site. The pits/beds shall be given antitermite treatment before backfilling.
4. Placing of plants - Plants shall be centre of pits plumb and straight.

- a. The LANDSCAPE ARCHITECTS shall inspect and approve placing of plants before the contractor proceeds with further operations.
  - b. Final Considerations - Topsoil shall be compacted around basin of balls to fill all voids. Roots shall be properly spread out and topsoil carefully worked in among them.
5. Watering - Immediately after plant pit is backfilled, a shallow base slightly larger than pit shall be formed with a ridge of soil to facilitate and contain watering. After planting, cultivate the soil between plant pit and rake smooth. Spray the soil with water to settle.
  6. Guying and staking - All plants shall be inspected for injury to trunks, evidence of insects infestation and improper pruning, staking shall be done immediately after planting. Trees shall stand straight after staking. A minimum of 3 stakes per tree shall be provided by contractor.
  7. LANDSCAPE ARCHITECTS shall inspect and approve plant pits before the contractor proceeds with placing of plants.

#### 9.20 DAFTER PLANTING CARE

1. Watering - Water trees and other plants by flooding twice within first 24 hours of the time of planting. Tree requires 6 gallons per plant per day for first 45 days from the date of planting and subsequently every alternate day for the next 6 months. Thereafter watering twice, a week at the rate of 10 gallons per plant.

#### 9.21 GUARANTEE

1. Period - all plants and lawns shall be guaranteed by the contractor for 12 (twelve) months after the certified date of completion.
2. Conditions: - During this period, any plant that missing, dead not true to name or size as specified, or not in satisfactory growth shall be replaced immediately of approved size and shape.
3. Replacement - All replacements shall be plants of the same species, variety and size as specified in the plant list. The cost of replacement resulting from removal, loss or damage due to the occupancy of the project in any part, or vandalism or acts of neglect on the part of others, in which case the cost will be borne by the clients.

**Note: The Code given are indicative however the contractor before procuring & executing the work shall ascertain & determine the applicable Japanese codes, which are required to be complied with Osaka Japan, and only there after the respective material should be used.**

## Technical Specifications of Audio/Video System

### 10 Chapter J

#### VIDEO SYSTEM

Sr no	Description
<b>Video System</b>	
<b>Hall of Color</b>	
1	<p>Supply of DLP Laser Phosphor projector with complete dust protection as per IP60 standards, Min. 13,000 ISO Lumens, Dual Laser for highly accurate color and saturated &amp; realistic images, Laser light source having 20,000 hrs. life, WUXGA (1920 x 1200) display resolution, Contrast ratio (Dynamic) min. 10,000:1, Having Mosquito function, 24 x 7 operation, Filter less operation with liquid cooled technology, PC configurable OEM software for control &amp; monitoring of projector from control room. Inputs: 1 x Display port, 1 x HDMI, 1 x HD BaseT, 3G-SDI in/out Controls: 3D sync in/out, RS232, Control: Crestron Room View, UST Straight down firing lens 0.39/0.38/0.37. Approved OEM Makes: Digital Projection, NEC, Panasonic or equivalent.</p>
2	<p>Supply of 3-Chip DLP RGB Modular Laser Light Source 20,000 Lumens or higher brightness Projection system, Sealed Optics, WUXGA (1920 X 1200) Display resolutions or better, Contrast Ratio: 2,000:1, 24/7 operation, Color Correction 7 point or higher, Support 10 bits per Color or higher, Robust lens mount with memorized position, Typical illumination Life: 20,000 hours or better, Projection cabinet size should not be more than H:32cm W:30cm L:35cm or less for compact and most unobtrusive installation on. Projection cabinet weight should be 20kg or less. Inputs: Display port, HDMI, HD BaseT, Controls: RS232, Control: Ethernet, Pjlink along with Suitable Lens as per site. Approved OEM Makes: Digital Projection, NEC, Panasonic or equivalent.</p>
3	<p>SITC of Media Server complete with Including Lifetime license for blending/ geometry correction, edge blending, color correction and 2D/3D mapping and hardware with following specs: The Media server should support 7680 x 4320@60px resolution. It should have 32GB DDR5 RAM, and i9 Processor, min. 2TB NVME Gen 5 storage, 10Gbps Ethernet and 6 x USB 3.2 ports and 7.1 Surround output, rack rail mountable chassis, with Integrated Graphic Card having min. 16GB Video Memory. It should be preloaded with Windows 10 enterprise. The server should have dedicated remote OS recovery functionality, with BIS Certification. Approved OEM makes: Dataton/ Vioso/ Delta or equivalent.</p>
4	<p>Supply of Equipment Rack - 19" standard Rack with all required accessories. Earthing community kit, mounting bracket, cable manager, support angle, equipment shelf, mounting hardware, fan housing units etc., Ventilated top and bottom covers with attractive styling. It has Removable side panels with slam latches for easy access.</p>



5	Supply of Video Transmitter and Receiver Set, Resolution Range Up to 4K (4096x2160) @ 60 Hz, Low power consumption, compliances CE, c-UL UL, CE**, C-tick, FCC Class A**, ICES Makes: Kramer/ Extron/ Lightware or equivalent.
6	Supply of 24port 10G Ethernet Network Switch Make: D-Link/ Cisco/ Netgear or equivalent.
7	Supply of Active DP to HDMI Adapter Make: Kramer/ Extron/ Startech or equivalent.
8	Supply of HDMI to HDMI Patch Cords 1.8MM Make: Kramer/ Extron/ Startech
9	Connectors and other accessories
10	Cables
11	Cost of Installation, Testing and Mapping
12	SITC of Show Control Software, Capable to Make 300 DPI GUI Panel, 2x1g Ethernet, Dual 512 DMX, Low Voltage I/O Controls,1x Video Sync and MIDI Out. with robust embedded OS. Make: Dataton/ Medialon / SCS
13	SITC of Multi-Channel Audio Player, Including 2 × RJ45 Dante ethernet ports. Up to 128 channels of 44.1 – 96 kHz / 16- or 24-bit digital audio on a Gigabit ethernet network. 2x 1G Ethernet, Make: Medialon / Soundman / Motu
14	SITC of 7" Touch Panel Compatible with web SSL, and WIFI 6E, 6000Mah Battery, Including Multitouch 400nits brightness, Make: Apple/ Samsung/ Crestron
15	SITC Support WIFI 6E wireless access point with seamless connectivity device to device. Make: Cisco / D-Link / Tp-link
<b>Auditorium</b>	
1	SITC of LED Wall with 1.25 pitch for 12.8x8.8meter Screen Dimensions, 600nits brightness with BIS Certification. Approved makes Samsung /Delta / LG
2	SITC of LED flexible led Wall with 1.25-2.2 pitch for 4000sq feet Screen Dimensions, 600nits brightness with BIS Certification. Approved makes Samsung /Delta / LG
2	3-Chip DLP Laser projector Min. 37,000 ISO Lumen, Support 4K-UHD (3840x2160) display resolution, Contrast ratio (Dynamic) min. 18000:1 or higher, 24 x 7 operation, Color Correction seven points, Selectable EDID, IP60 Rated sealed optics complete dust protection and filter less operation with liquid cooled technology and min. 0.06mm Conformal Coating on all critical PCBs for protection against environment and corrosion. Typical illumination Life: 20,000 hours or better. Inputs :1 x Display port, 2 x HDMI, 1 x HDBaseT, 3G-SDI in/out Controls: 3D sync in/out, Crestron Room View Connected, LAN, RS-232, AMX, DMX Art-Net. along with suitable lens. approved OEM make: Digital Projection, NEC, Panasonic or equivalent.

4	SITC of Media Server complete with Including software including Lifetime license for blending/ mapping geometry correction, edge blending, color correction and 2D/3D mapping and hardware with following specs: The Media server should support 7680 x 4320@60px resolution. It should have 32GB RAM, i9 Processor, min. 2TB NVME Gen 5 storage, 10GBP/S Ethernet and 6 x USB 3.2 ports, 7.1 Surround output, rack rail mountable chassis, with Integrated Graphic Card having min. 24GB Video Memory. It should be preloaded with Windows 10 enterprise. The server should have dedicated remote OS recovery functionality, with BIS Certification. Approved makes Dataton/ Vioso/ Delta
5	Supply of Equipment Rack - 19 " standard Rack with all required accessories. Earthing community kit, mounting bracket, cable manager, support angle, equipment shelf, mounting hardware, fan housing units etc., Ventilated top and bottom covers with attractive styling. It has Removable side panels with slam latches for easy access.
6	SITC of Wireless Presentation System, Support 4K-UHD Output Resolution, with Plug and Play USB type C Dongle with button press screen mirror. Make: Barco / Delta /Crestron
7	Supply of 10G Ethernet Network Switch Make: D-Link/ Cisco/ Netgear
8	Supply of active 1.4a DP to DP Patch Cords 3meter Make: Kramer/ Extron/ Startech
9	Connectors and other accessories
10	Cables
11	Cost of Installation, Testing and Mapping
<b>Conference Hall x2</b>	
1	SITC AIO with 1.38 pitch, 120" Diagonal, should have 3840 refresh rate, Contrast 10,000:1, Should have 160/160 Viewing angle, integrated Scaller, up to 4 Simultaneous Source Display, Control: 3x HDMI 2.0, Audio out 3.5mm, 1x Type C, 1x USB 3.0 1x USB 2.0. Make: Samsung / Delta / LG
2	Supply of Equipment Rack - 19 " standard Rack with all required accessories. Earthing community kit, mounting bracket, cable manager, support angle, equipment shelf, mounting hardware, fan housing units etc., Ventilated top and bottom covers with attractive styling. It has Removable side panels with slam latches for easy access.
3	SITC of Wireless Presentation System, Support 4K-UHD Output Resolution, with Plug and Play USB type C Dongle with button press screen mirror. Make: Barco / Delta /Crestron

4	Supply of Network Switch Make: D-Link/ Cisco/ Netgear
5	Cables
6	Connectors and other accessories
7	Cost of Installation, Testing and Mapping
<b>Conference Hall x2</b>	
1	SITC of 55" O-LED TV, Native 4k-UHD 120hz screen resolution

**NOTE: All equipment should support AC 100V 50/60Hz**

### AUDIO SYSTEM

S NO.	DESCRIPTION	SPECIFICATION
<b>Zone 1: Chat Pit</b>		
1	Dual 8" Line Array Loudspeaker With 110-Degree Dispersion	Dual 8" Line Array Loudspeaker With 110-Degree Dispersion, Frequency Range (-10 dB): 49 Hz - 19 kHz, Coverage Pattern (-6dB): Horizontal:110 degrees nominal (300 Hz - 18 kHz), Vertical: varies with array size and configuration, System Input Power Rating LF : 600W, MF/HF : 390W, Maximum Peak Output: 139 dB, System Impedance 8 Ohms, Low Frequency Driver: 2 x 8", Mid Frequency Driver: 4 x 3", High Frequency Driver: 2 x 2", IP Rating: IP55, Grill : Powder-coated 14-gauge hex-perforated steel with acoustically transparent black cloth backing,
2	Single 18" Subwoofer Loudspeaker	Single 18" Subwoofer, Frequency Response (-10dB) :28Hz - 80Hz, Coverage Pattern Omni-directional, Power Rating: 1300W Continuous, Max SPL :135dB, IP Rating: IP55, Nominal Impedance: 8ohms, LF Driver: Arrayable Single 18" Subwoofer
3	Array Frame	Array Frame for FOH Loudspeaker, Support for up to (24) enclosures, Compatible with line array and same format subwoofer, Several pick-point options, 0.5-degree pick-point resolution, Built-in storage position for extension bar, Support for 3rd-party laser inclinometers, Compatible shackle size: 5/8 in

4	Dual 10" Professional Stage Monitor	Dual 10" Professional Stage Monitor, Frequency Range (-10 dB): 55 Hz - 19.5 kHz, Coverage Pattern (-6dB) Horizontal: 60 x Vertical:60, Power Rating Passive: Active:1250 W Continuous, LF: 1250 W Continuous, HF: 100 W Continuous, Maximum Peak Output: 136dB, System Latency3: 3.33ms, System Impedance Passive: Active: 4 ohms, LF: 4 ohms, HF: 8 ohms, Monitor Angle:: 30 degrees, 2 x 10" LF Driver, 1 x 2" HF Driver
5	Four-channel x4000W @ 4Ω Power Amplifier	Four-channel x4000W @ 4Ω Power Amplifier, True Ethernet backbone – fast, reliable and scalable, Color LCD provides users with diagnostics and presets for easy setup, Sweep Load Monitoring, one USB port, Damping Factor :(10Hz to 100Hz) >5000, Signal to Noise Ratio ( 20Hz to 20kHz, A Weighted) :> -108dB, (THD) (full rated power, 20Hz to 20kHz) :0.35%, Intermodulation Distortion (from 9dB down to -40dB): 0.06%, Frequency Response (20Hz to 20kHz at 1W into 4/8Ω) :+/- 0.25dB, Crosstalk (below rated power 20Hz to 1kHz): >80dB
6	High-performance drum microphone set	<p>High performance drum microphone set and the ideal all-in-one starter kit that delivers an impressive combination of performance and value. With seven microphones and accessories packed in a durable aluminum carrying case, it provides all the essentials needed to capture a complete drum set. It can also be used for micing percussion, bass and guitar amps, brass, woodwinds and other instruments</p> <p>1 x Bass Drum Microphone , Audio frequency bandwidth :20 - 16000 Hz , Sensitivity :2.5 mV/Pa , Electrical impedance :400 Ohms , Recommended load impedance :2000 Ohms ,Polar Pattern : Cardioid , Reject EMC Noise</p> <p>2 x Microphones for overheads , Switchable attenuation pad For high SPL applications up to 155 dB SP, lightweight 1/2-inch true condenser transducer diaphragm, Audio frequency bandwidth: 20 - 20000 Hz, Equivalent noise level:19 dB-A, Sensitivity:1 5 mV/Pa, Signal to Noise :75 dB-A, Pre-attenuation Pad :-20 dB, Electrical impedance: &lt;= 200 Ohms, Recommended load impedance :&gt;=1000 Ohms, Polar Pattern: Cardioid</p> <p>4 x Microphones For Toms And Snare, High-performance dynamic instrument microphone, Humbucking coil rejects EMC noises, SPL up to 152dB, Audio frequency bandwidth: 40 - 18000 Hz, Sensitivity: 2.5 mV/Pa, Electrical impedance: 500 Ohms, Recommended load impedance: 2000 Ohms, Polar Pattern: Cardioid</p>

7	Wired Dynamic Vocal Microphone	Wired Dynamic Vocal Microphone, Dual shock mount microphone capsule, Super cardioid vocal microphone, Audio frequency bandwidth :70 - 20000 Hz, Sensitivity 2.6 mV/Pa, Electrical impedance: 600 Ohms, Recommended load impedance: 2000 Ohms, XLR Connector,
8	Wired Dynamic Instrument Microphone	Wired Dynamic Instrument Microphone, Cardioid Dynamic Instrument Microphone, Audio frequency bandwidth 50 - 20000 Hz, Sensitivity at 1000 Hz 2.5 mV/Pa (-52 dBV re 1 V/Pa), Equivalent noise level 18 dBA, Max. SPL for 1 % THD 147 dB SPL, electrical impedance ≥ 600 Ohms, Recommended load impedance ≥ 2000 ohms, XLR Connector,
9	Wireless Handheld Microphone System	Wireless Handheld Microphone System, Wireless Microphone system with MHz carrier frequency band, Up to 16 pre-programmed frequencies within the same frequency band, Audio bandwidth 35 - 20,000 Hz, THD at 1 kHz: <0.3% (Receiver) , Signal-to-noise: 120 dB(A) ( Receiver), Wideband FM Modulation, Up to 48 Simultaneous channels , Up to 14 hours operation with one single AA battery or better, Pilot Tone, transmission to know the transmitter battery status, Receiver should have microphone level and line level output, Transmitter should have display to show the battery and LED to show the Muted /Unmuted status, Sensitivity 6.3 dB V / - 100 dBm, Should have Microprocessor-controlled diversity, T.H.D.: 0.7 % (Transmitter), Infrared programmable, RF output power: 10 or 50 mW
10	Wireless Lavalier Microphone System	Wireless Lavalier Microphone System, Wireless Microphone system with MHz carrier frequency band, Up to 16 pre-programmed frequencies within the same frequency band, Audio bandwidth 35 - 20,000 Hz, THD at 1 kHz: <0.3% (Receiver), Signal-to-noise: 120 dB(A) ( Receiver), Wideband FM Modulation, Up to 48 Simultaneous channels, Up to 14 hours operation with one single AA battery or better, Pilot Tone transmission to know the transmitter battery status, Receiver should have microphone level and line level output, Transmitter should have display to show the battery and LED to show the Muted /Unmuted status, Sensitivity 6.3 dB V / - 100 dBm, Should have Microprocessor-controlled diversity, T.H.D. 0.7 % (Transmitter), Infrared programmable, RF output power: 10 or 50 mW

11	12 x 8 Networked Digital Signal Processor	12 x 8 Networked Digital Signal Processor ,DSP with 12 inputs and 8 outputs, 12 Control Inputs and 6 Logic Outputs for GPIO Integration, 48V phantom power on all analog inputs, THD: <0.01% 20Hz to 20KHz, +10dBu output, Crosstalk: <-75dB, Open architecture software configurable, Separate logic Processing power, 2 digital audio bus RJ 45 Port ,1 Ethernet port for Monitoring and configuration, Capable to handle +5V unloaded logic output voltage , at-least 6 ,Should have speech sense engine ,Capable to control 3rd party devices with TCP IP and RS 232 ,Should have 1nos of RS 232 port for integration with control System, Should have Bi-Directional Locate Functionality, Should have 48 or more digital audio Channel Bus, Should have monitoring LED for COM, STAT, ERR and PWR
12	8 analog output Expander	Eight Output channel Expansion unit, Output Expander; 8 Analog Output, SWL Digital Audio Bus 256, DIP Switches for Channel Range Selection, 1RU Chassis
13	32 Channel Digital mixing consoles	32 Channel Digital mixing console, 32-in/32-out USB Interface, iPad Control, 40-input Mic/Line, 31 Output busses, 8 VCAs + 8 Mute groups, 26 motorized faders (24 input + LR/Mono), 5" touchscreen display, Should Support MADi/Dante/cobranet Cards, 20 sub-group / aux busses, Multi-Color LCD Channel Displays on each input fader, 4 studio-grade Effects engines and dedicated FX busses, 4 mono/stereo matrix busses, Up to 80 channels to mix
14	32 Channel digital Stage Box	32 Channel Stage box Stage box 2 analogue inputs and 8-line outputs making 32 x 8 matrix. Should also have MADi output compatible with main mixer to run all the signals over CAT5 "
<b>Zone 2: Hall of Color</b>		
1	High Power 2-Way Loudspeaker with 1 x 15" LF & Rotatable Horn 120° x 60°, rotatable waveguide	High Power 2-Way Loudspeaker with 1 x 15" LF & Rotatable Horn, 1 x 15" LF full range two-way speaker Coverage Pattern: 120° x 60°, rotatable waveguide, Frequency Range: 34 Hz – 20 kHz, Frequency Response (±3 dB): 40 Hz – 20 kHz, Maximum SPL: 130 dB Peak (Passive mode), Passive Crossover Frequency: 1.4 kHz, Sensitivity: 96 dB SPL(Passive mode), 2400W peak at Passive mode, Should have Bi-amp mode, High Frequency Driver: 1.5 in
2	Custom Mounting Arrangement	

3	Dual 15-inch subwoofer	Flying, dual 15" LF or more subwoofer; Frequency Range 32 Hz – 1 kHz (-10 dB); Frequency Response 38 Hz – 1 kHz ( $\pm$ 3 dB); System Sensitivity (dB-SPL, 1W @ 1m)-100 dB; Maximum SPL-132 dB-SPL; Long-Term System Power Rating: 1350 W
4	Multichannel Digital Network Based Power Amplifier with Power output 4 x 1250W @ 4 Ohms / 8 Ohms	Multichannel Digital Network Based Power Amplifier with Power output 4 x 1250W @ 4 Ohms / 8 Ohms, Four-channel Audio amplifier , 4x 1250W at 4 and 8 Ohm, 70Vrms and 100Vrms output on all Four channels, THD (at full rated power, 20Hz - 20kHz) =0.35%, Cooling Continuously variable speed forced air, Voltage Gain Max level= 34dB, Audio Digital channel bus compatibility up to 8 channel, bridgeable channels - even in 100Vrms mode, 2 digital audio bus RJ 45 port, 1 Ethernet R 45 port for monitoring and configuration, Should have Limiters , Input/output EQ , Delay ,Matrix Mixer ,Speaker Line impedance Monitoring, Damping Factor (20 Hz to 100 Hz) : >1500
5	2 x 2400W Digital Network Based Power Amplifier	Dual Channel Digital Network Based Power Amplifier with Power output 2 x 2400W @ 4 Ohms / 8 Ohms, THD (at full rated power, 20Hz - 20kHz) =0.35%, Cooling Continuously variable speed forced air, Voltage Gain Max level= 34dB, Audio Digital channel bus compatibility up to 8 channel, bridgeable channels - even in 100Vrms mode, 2 digital audio bus RJ 45 port, 1 Ethernet R 45 port for monitoring and configuration, Should have Limiters, Input/output EQ , Delay, Matrix Mixer ,Speaker Line impedance Monitoring, Damping Factor (20 Hz to 100 Hz) : >1500
6	High Power Cinema Surround Loudspeaker 2-Way Passive 1" HF, 10" Woofer	High Power Cinema Surround Loudspeaker 2-Way Passive 1" HF, 10" Woofer, 300-watt power rating, Frequency Range ( $\pm$ 3 dB) :60 Hz – 20 kHz (2pi), Coverage Pattern: 110 <sup>o</sup> x 60 <sup>o</sup> asymmetric, >1 kHz, Half-Field (2pi) Sensitivity 99 dB SPL, 1 W @ 1m, Calculated Maximum dB SPL: 124 dB continuous, 130 dB peak, Rated Impedance :8 ohms, Minimum Impedance: 7 ohms @ 200 Hz, Crossover Frequency: 2600 Hz
7	Quick Mount Surround Bracket	Quick Mount Surround Bracket
8	Multichannel Digital Network Based Power Amplifier with Power output 8 x 600W @ 4 Ohms / 8 Ohms	Multichannel Digital Network Based Power Amplifier with Power output 8 x 600W @ 4 Ohms / 8 Ohms, Eight-channel Audio amplifier , 8x 600W at 4 and 8 Ohm, 70Vrms and 100Vrms output on all Eight channels, THD (at full rated power, 20Hz - 20kHz) =0.35%, Cooling Continuously variable speed forced air, Voltage Gain Max level= 34dB, Audio Digital channel bus compatibility up to 8 channel, bridgeable channels - even in 100Vrms mode, 2 digital audio bus RJ 45 port, 1 Ethernet R 45 port for monitoring and configuration, Should have Limiters, Input/output EQ, Delay, Matrix Mixer,

		Speaker Line Monitoring, Damping Factor (20 Hz to 100 Hz) : >1000
9	Compact full-range, pendant-type loudspeaker	Compact full-range, pendant-type loudspeaker , Frequency Response (-10 dB): 65 Hz - 15 kHz, Frequency Response (+/-3 dB) : 85Hz - 14 kHz ,Power Rating: 100 W Continuous Program ,Nominal Sensitivity: 88 dB Nominal, Coverage Angle3: 120°, Rated Maximum SPL @ 1m: 111 dB peak ,Rated Impedance: 8Ω, Transformer Taps: 70V: 30W, 15W, 7.5W & 3.7W/ 100V: 30W, 15W, 7.5W, Driver: 100 mm (4 in) polypropylene-coated paper with cloth surround, 20 mm (0.8 in) copper voice coil, Enclosure Material: High impact polystyrene, Grille: Zinc-plated steel grille with powder-coat finish, foam backing (removable for painting)Suspension: Two identical suspension systems (one as main suspension cable and the other as safety cable), each consisting of 4.5 m (15 ft) , long 2 mm (0.077 in) , Shall be UL Rated
10	7.1 AVR	7.1 AVR with Atmos Effect
11	12 x 8 Networked Digital Signal Processor	12 x 8 Networked Digital Signal Processor ,DSP with 12 inputs and 8 outputs, 12 Control Inputs and 6 Logic Outputs for GPIO Integration, 48V phantom power on all analog inputs, THD: <0.01% 20Hz to 20KHz, +10dBu output, Crosstalk: <-75dB, Open architecture software configurable, Separate logic Processing power, 2 digital audio bus RJ 45 Port ,1 Ethernet port for Monitoring and configuration, Capable to handle +5V unloaded logic output voltage , at-least 6 ,Should have speech sense engine ,Capable to control 3rd party devices with TCP IP and RS 232 ,Should have 1nos of RS 232 port for integration with control System, Should have Bi-Directional Locate Functionality, Should have 48 or more digital audio Channel Bus, Should have monitoring LED for COM, STAT, ERR and PWR
12	Wireless Lavalier Microphone System	Wireless Lavalier Microphone System, Wireless Microphone system with MHZ carrier frequency band, Up to 16 pre-programmed frequencies within the same frequency band, Audio bandwidth 35 - 20,000 Hz, THD at 1 kHz: <0.3% (Receiver), Signal-to-noise: 120 dB(A) ( Receiver), Wideband FM Modulation, Up to 48 Simultaneous channels, Up to 14 hours operation with one single AA battery or better, Pilot Tone transmission to know the transmitter battery status, Receiver should have microphone level and line level output, Transmitter should have display to show the battery and LED to show the Muted /Unmuted status, Sensitivity 6.3 dB V / - 100 dBm, Should have Microprocessor-controlled diversity, T.H.D. 0.7 % (Transmitter), Infrared programmable, RF output power: 10 or 50 mW
<b>Zone 3: Ramp Slope</b>		



1	In-Wall Loudspeaker-8-inch subwoofer Loudspeaker	50 W, In-Wall Loudspeaker-8 in cone woofer and 1 in tweeter, Frequency Range 38 Hz - 20 kHz (-10 dB), Transformer Taps 70 V & 100V: 50 W, 25 W, 12 W & 6 W. (S6), Power Capacity 200 W Peak, Nominal Impedance 8 ohms, Crossover Network 2nd order Low Pass
2	Eight-channel, 125W @ 4Ω Power Amplifier	Eight-channel 125W @ 4Ω Power Amplifier, Sensitivity :1.4 V , Rated Power Output (all channels driven): 125W per CH @ 4 ohms, 125W per CH @ 8 ohms, Signal to Noise Ratio (below rated power 20 Hz to 20 kHz, A-Weighted) 110 dB, THD (full rated power, 20 Hz - 20 kHz) : < 0.05% , Intermodulation Distortion (from 0 dB down to -30 dB) : < 0.05% , Frequency Response (at 1W, 4/8 ohms) : +/- 0.5 dB, Crosstalk (below rated power) 20 Hz to 1 kHz : > 70 dB , Common Mode Rejection (20 Hz to 1 kHz) >: 55 dB, typically :> 70 dB , Voltage Gain : 27 dB , IEC Power Connector 15A
3	Digital Signal Processor with 64x64 Dante/AES 67	DSP with 64x64 Dante/AES 67, Four Input / Output Card Slots ( 4 I/O card ), 12 Control Inputs and 6 Logic Outputs for GPIO Integration, 48V phantom power on all analog inputs, 256 Channel, Low Latency, Fault Tolerant Digital Audio Bus, Clear Front Panel LED Indication, Dante 4.0 firmware for integration with Dante Domain Manager, Signal Processing (MHz) :800, Open architecture software configurable, Separate logic processing power, 2 digital audio bus RJ 45 Port, 1 Ethernet port for Monitoring and configuration, Capable to handle +5V unloaded logic output voltage, at-least 6, Should have speech sense engine, Capable to control 3rd party devices with TCP IP and RS 232, Should have 1nos of RS 232 port for integration with control System, Should have Bi-Directional Locate Functionality, Should have 48 or more digital audio Channel Bus
4	Analog Input Card	Analog Input Card
5	Analog Output Card	Analog Output Card
6	8 analog output Expander	Eight Output channel Expansion unit, Output Expander; 8 Analog Output, SWL Digital Audio Bus 256, DIP Switches for Channel Range Selection, 1RU Chassis
<b>Zone 4: Auditorium</b>		
<b>Loudspeaker (# 6 Left Array &amp; # 6 Right Array)</b>		

1	Dual 8" Line Array Loudspeaker With 110-Degree Dispersion	Dual 8" Line Array Loudspeaker With 110-Degree Dispersion, Frequency Range (-10 dB): 49 Hz - 19 kHz, Coverage Pattern (-6dB): Horizontal:110 degrees nominal (300 Hz - 18 kHz), Vertical: varies with array size and configuration, System Input Power Rating LF : 600W, MF/HF : 390W, Maximum Peak Output: 139 dB, System Impedance 8 Ohms, Low Frequency Driver: 2 x 8", Mid Frequency Driver: 4 x 3", High Frequency Driver: 2 x 2", IP Rating: IP55, Grill : Powder-coated 14-gauge hex-perforated steel with acoustically transparent black cloth backing,
2	Single 18" Subwoofer Loudspeaker	Single 18" Subwoofer, Frequency Response (-10dB) :28Hz - 80Hz, Coverage Pattern Omni-directional, Power Rating: 1300W Continuous, Max SPL :135dB, IP Rating: IP55, Nominal Impedance: 8ohms, LF Driver: Arrayable Single 18" Subwoofer
3	Array Frame	Array Frame for FOH Loudspeaker, Support for up to (24) enclosures, Compatible with line array and same format subwoofer, Several pick-point options, 0.5-degree pick-point resolution, Built-in storage position for extension bar, Support for 3rd-party laser inclinometers, Compatible shackle size: 5/8 in
4	Four-channel x4000W @ 4Ω Power Amplifier	Four-channel x4000W @ 4Ω Power Amplifier, True Ethernet backbone – fast, reliable and scalable, Color LCD provides users with diagnostics and presets for easy setup, Sweep Load Monitoring, one USB port, Damping Factor :(10Hz to 100Hz) >5000, Signal to Noise Ratio ( 20Hz to 20kHz, A Weighted) :> -108dB, (THD) (full rated power, 20Hz to 20kHz) :0.35%, Intermodulation Distortion (from 9dB down to -40dB): 0.06%, Frequency Response (20Hz to 20kHz at 1W into 4/8Ω) :+/- 0.25dB, Crosstalk (below rated power 20Hz to 1kHz): >80dB
<b>Front Fill Loudspeaker</b>		
5	Compact 2-way Loudspeaker with 1 x 8" LF with Coverage Pattern- 120° x 60°	2-Way Loudspeaker, shall have Frequency Range: 58 Hz - 20 kHz (-10 dB), Frequency Response: 68 Hz – 19 kHz (±3 dB), Coverage Pattern- 120° x 60°, System Sensitivity (dB-SPL, 1W @ 1m)-92 dB, Maximum SPL: 113 dB, Nominal Impedance: 8 Ohms, Power Handling (Program):500W
6	Wall Mount Bracket	Wall Mount Bracket for above Loudspeaker, Wall Mount kit should be made by same speaker OEM, should have powder coting

7	Four Channel Digital Power Amplifier, 300W@4 Ohms	<p>Four Channel Digital Power Amplifier, 300W@4 Ohms, On-board Digital Signal Processor and includes these integrated features: Input Router, Input Delay – Up to 1000ms, Input Parametric EQ – 8 band, Crossover, Output Parametric EQ – 8 band, Output Delay – Up to 100ms, Limiter, should be controllable, configurable and monitorable through standard TCP/IQ network, each output channel should be capable of providing either 70V or 100V for high impedance applications. Completely configure the amplifier using an intuitive front-panel interface. Should have GPIO/AUX Port to Recall presets, mute channels, monitor faults, power on/off the amplifier, and more through a combined, Digital Signal Processing :96kHz, 32-bit floating point, Voltage Gain (at maximum level setting) 4/8Ω, 70Vrms and 100Vrms Operation : 34dB, Frequency Response (8Ω, 20Hz - 20kHz): +/-0.25dB, Total Harmonic Distortion (at full rated power, from 20Hz - 20kHz) : 0.35%, Analog Input Signal to Noise Ratio (ref. rated power, 100V,20Hz - 20kHz): &gt;104dB, Damping Factor (20Hz to 100Hz) : &gt;1000, Crosstalk (below rated power, 20Hz to 1kHz) : &gt;80Db</p>
<b>Stage Monitor Loudspeaker</b>		
8	12" Two-Way Self-Powered Stage Monitor Loudspeaker System	<p>12" Two-Way Self-Powered Stage Monitor Loudspeaker System, Frequency Range= 46 Hz – 19 kHz                      Class- D 1500W amplification, SPL = 134 dB peak, Coverage Pattern 90° x 50° nominal, Wi-Fi IOS app control to select the user preset, Crossover Frequency: 1.85 KHZ, User selectable presets for Main or Monitor position, Powder coated Grill, 100V - 240V ~ 50/60 Hz Operation, 2 x Balanced XLR and 2 x unbalanced RCA input, 8-band parametric EQ and up to 50ms of speaker delay</p>
9	Advanced Feedback Suppression	<p>Advanced Feedback Suppression, Stereo or Dual Independent Channel Processing, Max input line level = +20 dB, A/D Conversion =24-bit, THD+Noise 0.003%, Should have Wizard Setup Function, should have Full LCD Display, 24 Programmable Filters per Channel, Live and Fixed Filter Modes, 24 LED per Channel Filter Metering, Input Impedance: Balanced 50kΩ, Unbalanced 25kΩ, Frequency Response: 20Hz – 20kHz, +/- 0.5dB, Crosstalk input to output: &gt;80 dB</p>
<b>Microphone</b>		
10	High-performance drum microphone set	<p>High performance drum microphone set and the ideal all-in-one starter kit that delivers an impressive combination of performance and value. With seven microphones and accessories packed in a durable aluminum carrying case, it provides all the essentials needed to capture a complete drum set. It can also be used for miking percussion, bass and guitar amps, brass, woodwinds and other instruments</p> <p>1 x Bass Drum Microphone , Audio frequency bandwidth :20 -</p>

		<p>16000 Hz , Sensitivity :2.5 mV/Pa , Electrical impedance :400 Ohms , Recommended load impedance :2000 Ohms ,Polar Pattern : Cardioid , Reject EMC Noise</p> <p>2 x Microphones for overheads , Switchable attenuation pad For high SPL applications up to 155 dB SP, lightweight 1/2-inch true condenser transducer diaphragm, Audio frequency bandwidth: 20 - 20000 Hz, Equivalent noise level:19 dB-A, Sensitivity:1 5 mV/Pa, Signal to Noise :75 dB-A, Pre-attenuation Pad :-20 dB, Electrical impedance: &lt;= 200 Ohms, Recommended load impedance :&gt;=1000 Ohms, Polar Pattern: Cardioid</p> <p>4 x Microphones For Toms And Snare, High-performance dynamic instrument microphone, Humbucking coil rejects EMC noises, SPL up to 152dB, Audio frequency bandwidth: 40 - 18000 Hz, Sensitivity: 2.5 mV/Pa, Electrical impedance: 500 Ohms, Recommended load impedance: 2000 Ohms, Polar Pattern: Cardioid</p>
11	Wired Dynamic Vocal Microphone	Wired Dynamic Vocal Microphone, Dual shock mount microphone capsule, Super cardioid vocal microphone, Audio frequency bandwidth :70 - 20000 Hz, Sensitivity2.6 mV/Pa, Electrical impedance: 600 Ohms, Recommended load impedance: 2000 Ohms, XLR Connector,
12	Wired Dynamic Instrument Microphone	Wired Dynamic Instrument Microphone, Cardioid Dynamic Instrument Microphone, Audio frequency bandwidth 50 - 20000 Hz, Sensitivity at 1000 Hz 2.5 mV/Pa (-52 dBV re 1 V/Pa), Equivalent noise level 18 dBA, Max. SPL for 1 % THD 147 dB SPL, electrical impedance ≥ 600 Ohms, Recommended load impedance ≥2000 ohms, XLR Connector,
13	Wireless Handheld Microphone System	Wireless Handheld Microphone System, Wireless Microphone system with MHZ carrier frequency band, Up to 16 pre-programmed frequencies within the same frequency band, Audio bandwidth 35 - 20,000 Hz, THD at 1 kHz: <0.3% (Receiver) , Signal-to-noise: 120 dB(A) ( Receiver), Wideband FM Modulation, Up to 48 Simultaneous channels , Up to 14 hours operation with one single AA battery or better, Pilot Tone, transmission to know the transmitter battery status, Receiver should have microphone level and line level output, Transmitter should have display to show the battery and LED to show the Muted /Unmuted status, Sensitivity 6.3 dB V / - 100 dBm, Should have Microprocessor-controlled diversity, T.H.D.: 0.7 % (Transmitter), Infrared programmable, RF output power: 10 or 50 mW

14	Wireless Lavalier Microphone System	Wireless Lavalier Microphone System, Wireless Microphone system with MHz carrier frequency band, Up to 16 pre-programmed frequencies within the same frequency band, Audio bandwidth 35 - 20,000 Hz, THD at 1 kHz: <0.3% (Receiver), Signal-to-noise: 120 dB(A) ( Receiver), Wideband FM Modulation, Up to 48 Simultaneous channels, Up to 14 hours operation with one single AA battery or better, Pilot Tone transmission to know the transmitter battery status, Receiver should have microphone level and line level output, Transmitter should have display to show the battery and LED to show the Muted /Unmuted status, Sensitivity 6.3 dB V / -100 dBm, Should have Microprocessor-controlled diversity, T.H.D. 0.7 % (Transmitter), Infrared programmable, RF output power: 10 or 50 mW
15	Wired Gooseneck Microphone with Desktop base unit and on/off switch for Podium	Wired Gooseneck Microphone with Desktop base unit and on/off switch for Podium, Desktop gooseneck Mic with programmable Function push to talk, push to mute, push on/off, low cut on/off, Audio frequency bandwidth 70 - 18000 Hz, Polar pattern Cardioid, Max. SPL 125 dB (for 1% THD), Equivalent noise level <21 dB-A, Signal to Noise: >73 dB, Impedance <=600 ohms, Recommended load impedance >=2,000 ohms, Length 500 mm, Voltage 9V to 52V Power Interface, Current 3mA, Connector 3-pin male XLR
16	12 x 8 Networked Digital Signal Processor	12 x 8 Networked Digital Signal Processor ,DSP with 12 inputs and 8 outputs, 12 Control Inputs and 6 Logic Outputs for GPIO Integration, 48V phantom power on all analog inputs, THD: <0.01% 20Hz to 20KHz, +10dBu output, Crosstalk: <-75dB, Open architecture software configurable, Separate logic Processing power, 2 digital audio bus RJ 45 Port ,1 Ethernet port for Monitoring and configuration, Capable to handle +5V unloaded logic output voltage , at-least 6 ,Should have speech sense engine ,Capable to control 3rd party devices with TCP IP and RS 232 ,Should have 1nos of RS 232 port for integration with control System, Should have Bi-Directional Locate Functionality, Should have 48 or more digital audio Channel Bus, Should have monitoring LED for COM, STAT, ERR and PWR
17	8 analog output Expander	Eight Output channel Expansion unit, Output Expander; 8 Analog Output, SWL Digital Audio Bus 256, DIP Switches for Channel Range Selection, 1RU Chassis

18	Active DI Box for audio connectivity	Active DI Box for audio connectivity Frequency Response: 30Hz to 20kHz, +0dB/-1dB, Input Impedance: 1 MOhm (pad at 0dB), 47 kOhm (pad at -20dB or -40dB), Max Input: +9dBu (pad at 0dB), +29dBu (pad at -20dB), +49dBu (pad at -40dB), Input Connectors: Two Parallel 1/4" jack connectors (Tip Hot +ve, Sleeve ground), and a parallel XLR connector (unbalanced) (Pin 2 Hot +ve, Pin 1 & 3 ground), Output: Transformer Balanced, Max Output: +8dBu into 600 Ohms or greater, Output Connectors: XLR3-32 or equivalent, THD < 0.005% at 1kHz, 0dbu output, Noise: < -105db unweighted, 22hz-22khz,
19	32 Channel Digital mixing consoles	32 Channel Digital mixing console, 32-in/32-out USB Interface, iPad Control, 40-input Mic/Line, 31 Output busses, 8 VCAs + 8 Mute groups, 26 motorized faders (24 input + LR/Mono), 5" touchscreen display, Should Support MADi/Dante/cobranet Cards, 20 sub-group / aux busses, Multi-Color LCD Channel Displays on each input fader, 4 studio-grade Effects engines and dedicated FX busses, 4 mono/stereo matrix busses, Up to 80 channels to mix
20	32 Channel digital Stage Box	32 Channel Stage box Stage box 2 analogue inputs and 8-line outputs making 32 x 8 matrix. Should also have MADi output compatible with main mixer to run all the signals over CAT5 "
21	8 Language Interpretation System	SITC of 7 Channel, Integrated eight relay languages in addition to the floor. The unit also supports multiple Interlocking modes. A large color display shows both relay and outgoing language channels. The relay 'quality' of each pre-selected language is shown, indicating if the monitored language is original from the talker, a direct interpretation, or relay interpretation,
22	Delegate Unit	SITC of Conference System is able to cover of functions: discussion, dual discussion, identification, dual identification, voting, dual voting, simultaneous interpreting and language selection, multi-language selection.
23	Chairman Unit	SITC of Conference System is able to cover of functions: discussion, dual discussion, identification, dual identification, voting, dual voting, simultaneous interpreting and language selection, multi-language selection.
<b>Zone 5 Conference Hall X 2</b>		

1	Two-Way 4" Coaxial Ceiling Loudspeaker	Two-Way 4" Coaxial Ceiling Loudspeaker, Frequency Range :74 Hz – 20 kHz, Power Capacity: 60 Watts, should have 70/100V Transformer taps, Nominal Coverage Angle: 120° conical, Rated Maximum SPL:108 Peak, HF Driver: 19 mm or better, Materials: ABS baffle with UL94-V0 and UL94-5VB flame class fire rating, Safety Agency: UL1480, UL2043, NFPA90 & NFPA70; S7232/UL Listed
2	2 x 120 W @ 8 Ohm, Power Amplifier	Dual Channel Power Amplifier 120W @ 4 ohm/ 8 ohm per channel, "Audio Amplifier with Power Output: 2 x 120W at 100V/70V and 8/4 ohm", Input Sensitivity: 1.4Vrms for 8-ohms, Input Impedance 20K ohms, should have one RJ45 port
3	Wireless Handheld Microphone System	Wireless Handheld Microphone System, Wireless Microphone system with MHZ carrier frequency band, Up to 16 pre-programmed frequencies within the same frequency band, Audio bandwidth 35 - 20,000 Hz, THD at 1 kHz: <0.3% (Receiver) , Signal-to-noise: 120 dB(A) ( Receiver), Wideband FM Modulation, Up to 48 Simultaneous channels , Up to 14 hours operation with one single AA battery or better, Pilot Tone, transmission to know the transmitter battery status, Receiver should have microphone level and line level output, Transmitter should have display to show the battery and LED to show the Muted /Unmuted status, Sensitivity 6.3 dB V / - 100 dBm, Should have Microprocessor-controlled diversity, T.H.D.: 0.7 % (Transmitter), Infrared programmable, RF output power: 10 or 50 mW
4	Wireless Lavalier Microphone System	Wireless Lavalier Microphone System, Wireless Microphone system with MHZ carrier frequency band, Up to 16 pre-programmed frequencies within the same frequency band, Audio bandwidth 35 - 20,000 Hz, THD at 1 kHz: <0.3% (Receiver), Signal-to-noise: 120 dB(A) ( Receiver), Wideband FM Modulation, Up to 48 Simultaneous channels, Up to 14 hours operation with one single AA battery or better, Pilot Tone transmission to know the transmitter battery status, Receiver should have microphone level and line level output, Transmitter should have display to show the battery and LED to show the Muted /Unmuted status, Sensitivity 6.3 dB V / - 100 dBm, Should have Microprocessor-controlled diversity, T.H.D. 0.7 % (Transmitter), Infrared programmable, RF output power: 10 or 50 mW

5	Boundary Layer Microphones	Boundary Layer Microphones, shall have Cardioid polar pattern reduces background noise and provides an impressive gain before feedback, shall have 12-48 V phantom power operation, Capable of withstanding up to 120 dB SPL with-out distortion, shall have RFI suppression, shall have a three-position BASS-TILT switch: FLAT, CUT, and BOOST. Low-frequency response is adjustable, Polar pattern: cardioid, Frequency range: 50 to 20,000 Hz, Impedance: 150 ohms, Sensitivity: 22 mV/Pa (-30 dBV), Equivalent noise level: 22 dB-A, shall have silent-operating programmable membrane switch that can be configured for touch ON/OFF, Momentary ON or momentary OFF. A high-intensity LED lights when the unit is on.
6	12 x 8 Networked Digital Signal Processor	12 x 8 Networked Digital Signal Processor ,DSP with 12 inputs and 8 outputs, 12 Control Inputs and 6 Logic Outputs for GPIO Integration, 48V phantom power on all analog inputs, THD: <0.01% 20Hz to 20KHz, +10dBu output, Crosstalk: <-75dB, Open architecture software configurable, Separate logic Processing power, 2 digital audio bus RJ 45 Port ,1 Ethernet port for Monitoring and configuration, Capable to handle +5V unloaded logic output voltage , at-least 6 ,Should have speech sense engine ,Capable to control 3rd party devices with TCP IP and RS 232 ,Should have 1nos of RS 232 port for integration with control System, Should have Bi-Directional Locate Functionality, Should have 48 or more digital audio Channel Bus, Should have monitoring LED for COM, STAT, ERR and PWR
7	6 Module Connection Ports	6 Module Connection Ports, 1 x Power Outlet (IN) Module, 1 x HDMI Port, 2 x RJ45 Port, 2 x USB Charging Port, 1 M Blank Panel



8	4K60 Twisted Pair Transmitter	<p>4K60 Twisted Pair Transmitter, shall have 4K60 4:4:4 transmitter which supports up to four sources via traditional HDBaseT, shall have onboard USB 2.0 available on the HDBT allows for easy distribution of USB signals between the transmitter and receiver. A USB device, such as conferencing soundbar, can be mounted at the display and connected to a receiver. A laptop can then connect to the transmitter at the table, with USB and video distributed over category cable.</p> <p>4K60 4:4:4 and HDCP 2.2 Support over HDBaseT with Display Stream Compression (DSC)– Visually lossless compression and future-proof support , Power over HDBaseT – Can be powered from HDBaseT inputs which means there is no need for an additional power source at the table ,Twisted Pair Cable Type Shielded Cat6, Cat6A and Cat7 / Shielded Cat6A and Cat7, Twisted Pair Cable Length Up to 328 ft. (100 m) ,HDBaseT Layer Throughput (Max) 10.2 Gbps, Shall have 1xHDMI , 1x HDBT Output , Shall serial port , Shall have IR TX and RX ports , Input Signal Type HDMI, HDCP DVI , Data Rate (Max) :18 Gbps ,Pixel Clock (Max) Up to 600 MHz, Regulatory Compliance CE, FCC, NRTL, RoHS, WEEE</p>
9	4K twisted pair receiver	<p>4K twisted pair receiver , shall be capable to receive Ultra High Definition (UHD) and 4K60 4:4:4 signal without modifying the color space or reducing the frame rate ,HDMI 2.0 and HDCP 2.2 Support , USB 2.0 – Utilize for a convenient way to connect USB 2.0 devices such as HID compliant , keyboard and mouse, monitors, and projectors, as well as web cameras, microphones and storage devices, shall support Standard Twisted Pair Cable ,Transport Layer Throughput (Max) :10.2 Gbps ,Twisted Pair Cable Length: Up to 262 ft. (80 m) for full 4K format support and Up to 328 ft. (100 m) for 1080p and below format support , shall have Bidirectional RS-232 serial port to control the devices , Compatible Formats : HDMI , HDCP, DVI, Output Re-clocking : Yes , Propagation Delay (Typical) : 5 microseconds , Video Data Rate (max) : 18 Gbps (Max) , Video Pixel Clock (max): Up to 600 MHz , Output Format Matched to incoming video resolution up to 4K60 4:4:4 HDMI 2.0, HDCP 2.2 ,HDCP Support: Yes, including HDCP 1.x and HDCP 2.2</p>

<p>10</p>	<p>4x2 4K60 HDMI Switcher</p>	<p>4x2 4K60 HDMI Switcher, HDMI 2.0 4K60 4:4:4 Video, High Dynamic Range (HDR) and Deep Color Support, HDCP 2.2 EDID Management, Audio De-Embedding, firmware re-writing via USB, Open API Control over IP and Serial, full Web GUI console, and front panel buttons, Video Inputs: (4) HDMI; supports HDMI/HDCP, Video Outputs: (2) HDMI; supports HDMI/HDCP, Video Resolution Support Various up to 4096 x 2160@ 60 Hz, Audio Inputs Embedded audio on HDMI; supports 2 CH L-PCM de-embedding and pass-through of PCM 2-Channel, PCM Multi-Channel, Dolby Digital, Dolby Digital Plus, Dolby Atmos, Dolby TrueHD, DTS, &amp; DTS HD MA, Audio Outputs: (2) 3 Position 3.5mm pluggable Phoenix Terminal Block; supports Unbalanced Analog Stereo, 12V Power: (1) Screw Down Locking Power Connector, Ethernet: (1) RJ45 Connector, Analog Stereo Output: (2) 3 Position 3.5mm pluggable Phoenix Terminal Block, RS-232: (1) 3 Position 3.5 mm pluggable Phoenix Terminal Block, Regulatory Compliance FCC, EN, UL, RoHS</p>
<p>11</p>	<p>4K60 4:4:4 single input/output configurable scaler</p>	<p>4K60 4:4:4 single input/output configurable scaler, 4K60 4:4:4 and HDCP 2.2 Support, Single Input/Output, Automatic Scaling Option , HDMI Input (1) HDMI Type A female connector, HDMI Output (1) HDMI Type A female connector, 4K Format Support 3840x2160p@24/25/30/60 Hz, 4:4:4, 4096x2160p@24/25/30/60 Hz, 4:4:4, 3840x2160p@50/60 Hz, 4:2:0, 4096x2160p@50/60 Hz, 4:2:0, Audio Format Support 2 CH L-PCM, HDCP Support Yes HDCP 1.4, 2.2, CEC Support Yes, Auto or Manual, Data Rate (Max) 18 Gbps Pixel Clock (Max) Up to 600 MHz</p>
<p>12</p>	<p>Integrated Controller</p>	<p>Integrated Controller, Dual Network Interface card, Should support IPv6 , Shall Supports IEEE Standard for Port-based Network Access Control with the ability to grant or deny network access to devices wishing to attach to a LAN based on credentials tied to the device rather than to a user, Should have High Performance Architecture, Flexible Programming Platform Java, Should have ability to manage secure port TLS and SSH communications with a remote device or server, Enhanced Diagnostics On Serial and IR Ports , Hardware / Software should be Built for 24/7/365 Operation, Should have Ultra-Fast 1600 MIPS processor , 512 MB Onboard RAM , 1 M Non-Volatile Memory, 8 GB SDHC FLASH Memory ,1 RU Rack Space ,10/100 LAN Interface ,4 Digital I/O Ports , 1 RS-232/422/485 Port , 3 RS-232-Only Ports , 4 IR/Serial Output Ports , 4 Relay Ports, Shall be supplied with OEM recommended power supply , Regulatory Compliance :RoHS ,WEEE</p>

13	10.1" Professional-Grade, Persona-Defined Touch Panel	10.1" Professional-Grade, Persona-Defined Touch Panel, Pre-loaded Web Kiosk, Zoom Rooms Controller, stand-alone room scheduling touch panel. customizable panel to serve the unique needs of any user, Mounting Flexibility, Advanced Security – Supports HTTPS, 802.1X, TLS 1.3, Modern Authentication or OAuth 2.0, and FIPS 140-3, Over 1 million programmatically selectable colors, Communication-enabling Technologies- Speakers, microphone, and Front-facing HD camera, Intelligence-enhancing Technologies – NFC Read/Write, Proximity Sensor, Ambient Light Sensor, Display Type TFT-LCD, IPS, Resolution 1920x1200, Aspect Ratio 16:10 Landscape, Brightness 350 nits (cd/m2), Contrast Ratio >800:1, Viewing Angle >80°/80°/80°/80°, RAM 4GB, LPDDR4, Storage 16 GB eMMC, Ethernet RJ-45, USB Type C OTG, USB Type 2.0, Speakers 2 x 2W, Microphone Dual, Power POE RJ-45, POE 802.3af, 15.4W, Compliance UL, CE, CB, FCC Class B
----	---	---

**NOTE:** All equipment should support AC 100V 50/60Hz

### LIGHTING SYSTEM

S No.	Description
<b>Zone 1 Chat Pit</b>	
1	SITC of Moving Head with 400-watt LED Light source, Smooth electronic dimming and fast strobe effects, 3 Faceted Prism, Lux Level < 10,000 LUX, Angle: Pan/Tilt rotation: 540°/260°, Rotating Gobo: 7Gobos, Static gobo wheel 9 gobos, Colors: CMY independently variable 0-100%, RDM, DMX512, IP67 rated. Approved make: DTS / martain / Claypacky
2	SITC of LED Wash: 100W RGBL/A, AC100~240V, 6°/15°/22°/30° Standard Optics, 16-bit, IK10, IP67 Approved make: DTS / martain / Claypacky
3	SITC of LED Wash: 400W RGBL/A, AC100~240V, 6°/15°/22°/30° Standard Optics, 16-bit, IK10, IP67 Approved make: DTS / martain / Claypacky
4	SITC of Signal Amplifier and Splitter: 8 Channel, Supports RDM and DMX 512, IP20, Din Rail Mounting. Approved make: DTS / martain / Claypacky
5	SITC of Lighting Console, controller of different DMX system from RGB/RGBW to more advanced moving and color mixing luminaries. The quad channel DMX 512 controller including RTC/calendar, Ethernet facilities, dry contact port triggering, multi-zone programming from panel itself can run from internal memory. The lighting levels, colors and effects can be programmed from a PC using the DMX software including following additional accessories etc. as required. approved make: malighting / Avolight / obsidian
<b>Hall of Color</b>	

1	SITC of Animation Laser: Source - Laser Diode: 5w RGB/RGBY, Power Consumption ≤ 400w, Scanner - 40kpps, Scan Angle - ±30°, Linearity Distortion <2%, Beam Diameter and Divergence: 9x6.5mm, 1.2mrad, Control modes - Integrated Hardware to Support Animation Software Over ILDA or CAT6, Ingress Protection - IP65 Approved make: DTS / martain / Claypacky
2	SITC of Moving Head with 400-watt LED Light source, Smooth electronic dimming and fast strobe effects, 3 Faceted Prism, Lux Level < 10,000 LUX, Angle: Pan/Tilt rotation: 540°/260°, Rotating Gobo: 7Gobos, Static gobo wheel 9 gobos, Colors: CMY independently variable 0-100%, RDM, DMX512, IP67 rated Approved make: DTS / martain / Claypacky
3	SITC of Water Based Haze Machine approved make: Martain / Antari / LBT PRO
4	SITC of & 7 Channel Fragrance Aroma, DMX Controlled, approved make: Aroma-sent / We9 or equivalent
5	SITC of CAT6 To DMX Converter or Artnet: 2 Universe, Supports RDM and DMX 512, IP20, DIN RAIL Mounting Available. approved make: Martain / Antari / LBT PRO
6	SITC of Signal Amplifier and Splitter: 8 Channel, Supports RDM and DMX 512, IP20, Din Rail Mounting. Approved make: DTS / martain / Claypacky
<b>Auditorium</b>	
1	SITC of Moving Head with 400-watt LED Light source, Smooth electronic dimming and fast strobe effects, 3 Faceted Prism, Lux Level < 10,000 LUX, Angle: Pan/Tilt rotation: 540°/260°, Rotating Gobo: 7Gobos, Static gobo wheel 9 gobos, Colors: CMY independently variable 0-100%, RDM, DMX512, IP67 rated. Approved make: DTS / martain / Claypacky
2	SITC of LED Wash: 100W RGBL/A, AC100~240V, 6°/15°/22°/30° Standard Optics, 16-bit, IK10, IP67 Approved make: DTS / martain / Claypacky
3	SITC of LED PAR 280W all led based light, IP 67 rated, Standard Optics pass throw, AC 100V Approved make: DTS / martain / Claypacky
4	SITC of LED Wash: 400W RGBL/A, AC100~240V, 6°/15°/22°/30° Standard Optics, 16-bit, IK10, IP67 Approved make: DTS / martain / Claypacky
5	SITC of CAT6 To DMX Converter or Artnet: 2 Universe, Supports RDM and DMX 512, IP20, DIN RAIL Mounting Available. Approved make: DTS / martain / Claypacky
6	SITC of Signal Amplifier and Splitter: 8 Channel, Supports RDM and DMX 512, IP20, Din Rail Mounting. Approved make: DTS / martain / Claypacky
7	SITC of Lighting Console, controller of different DMX system from RGB/RGBW to more advanced moving and color mixing luminaries. The quad channel DMX 512 controller including RTC/calendar, Ethernet facilities, dry contact port triggering, multi-zone programming from panel itself can run from internal memory. The lighting levels, colors and effects can be programmed from a PC using the DMX

	software including following additional accessories etc. as required. approved make: malighting / Avolight / obsidian
<b>Façade Lighting</b>	
1	SITC of Moving Head with 400-watt LED Light source, Smooth electronic dimming and fast strobe effects, 3 Faceted Prism, Lux Level < 10,000 LUX, Angle: Pan/Tilt rotation: 540°/260°, Rotating Gobo: 7Gobos, Static gobo wheel 9 gobos, Colors: CMY independently variable 0-100%, RDM, DMX512, IP67 rated. Approved make: DTS / martain / Claypacky
2	SITC of LED Batten: 200W RGBW, AC100~240V, 6°/15°/22°/30° tilt function, 16-bit, IP67 Approved make: DTS / martain / Claypacky
3	SITC of LED PAR 280W all led based light, IP 67 rated, Standard Optics pass throw, AC 100V Approved make: DTS / martain / Claypacky
4	SITC of Signal Amplifier and Splitter: 8 Channel, Supports RDM and DMX 512, IP20, Din Rail Mounting. Approved make: DTS / martain / Claypacky

**NOTE: All equipment should support AC 100V 50/60Hz**

All the codes and compliances irrespective of what is mention, shall be the codes and compliances as applicable in Osaka, Japan.

## MAKES OF EQUIPMENT

### 11 Chapter K

Note:

The tendered must indicate the makes he has used to cost his tender. An alternate make may be indicated as a substitute to be used if the offered make become unavailable. More than (2) two makes are Not to be indicated.

**Makes:** If the makes of the material mentioned here in are not available or single then the contractor may propose the equivalent product of the “make”/manufacturers which is available in Japan fulfilling the local laws and compliances suitable the functions for which is meant and decisions of Engineer in Charge/ ITPO shall be final.

<b>LIST OF APPROVED MAKES FOR CIVIL WORKS</b>		
<b>S.No.</b>	<b>Details of equipment/ material</b>	<b>Make/Manufacturer</b>
1	Cement	Taiheiyo Cement, Denka, Sumitomo Osaka Cement
2	Chlorpyriphios	DE-NOCIL, Cyanamide or approved equivalent
3	Structural Sealant	Wacker, Dow Corning, GE, Shin-Etsu Chemical
4	Structural Steel	Nippon steel corporation, JSW
5	M.S. Pipe, Tubes, Bar, Flats, Angle Tee Sections	Sail, Nippon steel or approved equivalent
6	Concrete admixture	Mitsubishi Materials Corporation, Sumitomo Metal Mining Co.Ltd, Sekisui Chemical Co. Ltd, Tosoh Corporation
7	Polysulphide sealant	Torayfine Chemicals, Kouei or approved equivalent
8	Bitumen Impregnated Board	Cellflex, Sdjinhonyao or approved equivalent
9	Polyethylene back up rod	Japan Polyethylene, Arindustries, Japan Polychem or approved equivalent
10	PVC water stops	CI Takiron, Jp Specialties or approved equivalent
11	White Cement	Taiheiyo Cement, Denka, Sumitomo Osaka Cement
12	Water proofing membrane	Sumitomo bakelite co. ltd, Ozeki-Chemical co. ltd, Nisshin Kogyo
13	Water proofing compound	Sumitomo bakelite co. ltd, Ozeki-Chemical co. ltd, Nisshin Kogyo
14	White washing lime	Yoshizawa, Kotegawa Sangyo or approved equivalent

15	Paints	Nippon, Kansai, Chugoku Marine, SK Kaken
16	Fire Retardant paint	Kansai Paint, Sekisuichemical or approved equivalent
17	Epoxy	Kaneka Corporation, Dic Corporation, Schenker Seino co.ltd, Adeka Corporation
18	Waterproof Ply	Qiansheng International, Linyi Yonghong, Hanwa, ike trading
19	Glulam and other timber products	Shelter, Rubner, Wiehag or equivalent
20	APP Polymeric Polyethylene Felt	'BITUMAT' or approved equivalent
21	Expanded Polystyrene (Thermocole) Extruded Polystyrene	Beardshell or approved equivalent Iso board ND or approved equivalent
22	Hessian Based Felt	'BITUMAwT' or approved equivalent
23	Commercial Quality White Glazed Ceramic Tiles	Orient or approved equivalent
24	PVC strips	LIN-YANG or approved equivalent
25	Welding rod	Nippon Welding Rod, Shinwa Corporation
26	Coupler	DEXTRA, ARISE

**LIST OF APPROVED MAKES FOR EQUIPMENT & MATERIALS PLUMBING SYSTEM**

S. No.	Details of Materials / Equipment	Manufacturer's Name
1.	VITREOUS CHINA SANITARYWARE	TOTO ACQUAVIVA/KOHLER/ROCA/
2.	WC PAN CONNECTOR	MC ALPINE/ STUDOR
3.	CP BRASS BATH FITTINGS	ACQUAVIVA/KOHLER/ROCA/TOTO
4.	STAINLESS STEEL SINK	PARYWARE /EQUIVALENT
5.	AUTO URINAL FLUSH SYSTEM	EURONICS /ROCA/EQUIVALENT



6.	HAND DRIER	EURONICS/CMR/BHARAT PHOTON
7.	CISTERN	VIEGA/GEBRIT
8.	GEYSER	RACOLD/AO SMITH
9.	FLOOR DRAIN FIXTURE RAIN WATER OUTLETS	VIEGA/ GEBRIT
10.	CP GRATING FOR FLOOR TRAP	VIEGA/GMGR/NEER
11.	UPVC PIPE	SUREME /AKG/EQUIVALENT
12.	UPVC FITTINGS	SUREME /AKG/EQUIVALENT
13.	SUSPENDED MANHOLE & GULLY TRAP	
14.	GI / MS PIPE	Nadong materials or equivalent
15.	GI PIPE FITTINGS	NVR/MAC/UNIK
16.	GI PIPE SEALANT	HENKEL- LOCTITE 55/EQUIVALENT
17.	PIPE CLAMP & SUPPORT	CHILLY EURO CLAMP
18.	UPVC PIPE	SUPREME /EQUIVALENT
19.	CPVC PIPES	SUPREME/EQUIVALENT
20.	PP-r PE 80 (ML5) AND FITTINGS	POLOPLAST- GERMANY/PESTAN-SERBIA
21.	PEX PIPE AND BRASS FITTINGS	GIACOMINI/VIEGA/REHAU/HULIOT
22.	PVC-U PIPE	SUPREME/LOCAL BS APPROVED
23.	GULLEY TRAP	LOCAL BS APPROVED
24.	GM /FORGED BRASS BALL VALVES	/AUDCO/NEW/EQUIVALENT
25.	SLUICE VALVE	AUDCO/NEW/EQUIVALENT
26.	BUTTERFLY VALVE	AUDCO/NEW/EQUIVALENT
27.	CHECK VALVE-WAFER TYPE	AUDCO/NEW/EQUIVALENT
28.	CHECK VALVE-DUAL PLATE	AUDCO/NEW/EQUIVALENT
29.	CHECK VALVE-FORGED SCREWED	AUDCO/NEW/EQUIVALENT

30.	PRESSURE REDUCING VALVE	HONEYWELL/ WATTS/
31.	SOLENOID VALVE	DANFOS/ HONEYWELL
32.	THERMOSTATIC VALVE	OVENTROP/EQUIVALENT
33.	AIR RELEASE VALVE	ADVANCE/AIP
34.	BALL FLOAT VALVE	SAWAMURA VALVE
35.	NRV-BALL TYPE-SEWAGE APPLICATION	DANFOS
36.	Y STRAINER CI	AUDCO/KITZ
37.	HYDROPNEUMATIC SYSTEM	GRUNDFOS/XYLEM/WILLO-MATHER & PLATT/XYLEM
38.	STORM WATER DRAINAGE & SEWAGE SUMP PUMPS	GRUNDFOS/XYLEM/WILLO-MATHER & PLATT
39.	TRANSFER PUMPS	GRUNDFOS/XYLEM/WILLO-MATHER & PLATT
40.	SELF PRIMING PUMP	GRUNDFOS/XYLEM/WILLO-MATHER & PLATT
41.	MECHANICAL SEAL	BURGMANN/ Torishima
42.	COUPLINGS	LOVE JOY/EQUIVALENT
43.	ANTYVIBRATION MOUNTING & FLEXIBLE CONNECTION	DUNLOP
44.	PRESSURE GAUGE	FIEBIG/EMERALD
45.	WATER METER (MECHANICAL TYPE)	ACTARIS/TOSHIN
46.	ELECTRONIC FLOW METER	KROHNE/TOFLO
47.	LEVEL CONTROLLER & INDICATOR WATER	SENSEZ / TAKUWA
48.	PAINTS	Nippon Paints/ Kansai Paint
49.	MH/WATER TANK PLASTIC STEP	Sekisui

50.	INSULATION FOR HOT WATER PIPE	ARMACELL-ARMAFLEX/K-FLEX/THERMAFLEX
51.	THREE WAY MOTORISED VALVE	DANFOSS/HONEYWELL/SIEMENS
52.	GREASE TRAP	ACO/WADE/EQUIVALENT
53.	WELDING RODS	NIPPON/ADOR/ESSAB/EQUIVALENT
54.	FASTENER	FISHER/HILTI/EQUIVALENT
55.	FIRE SEALANT	3M/HILTI
56.	MANHOLE(PREFABRICATED)	NIPPON/CRESCENT FOUNDARY/LOCAL BS APPROVED
57.	TEMPERATURE SENSOR/GAUGE	WIKA
58.	DOSING PUMPS	LMI/PULSER FEEDER
59.	FLANGES	CLASS 150 TABLE H
60.	U.V STERLIZER	EUREKA
61.	FLOW CONTROL DEVICES	JAQUAR/RST
64.	IRRIGATION SYSTEM	RAIN BIRD/EQUIVALENT
65.	MIRROR	MURAKAMI, EMIRATES
66.	PRESSURE REDUCING VALVE	HONEYWELL/EQUIVALENT
67.	PTRAP	MC ALPINE/ STUDOR
68.	WATER COOLER	YUZAMASHI, West brass

<b>ELECTRICAL ACCESSORIES</b>		
69.	MOTOR CONTROL CENTER	ADLEC CONTROL SYSTEM
70.	VARIABLE SPEED DRIVES	DANFOS/ABB/SIEMENS
71.	MOULDED CASE CIRCUIT BREAKER(MCB)	SCHNEIDER ELECTRIC/SIEMENS
72.	STARTER CONTACTOR	

73.	MINIATURE CIRCUIT BREAKER(MCB)	HAGER/ SCHNEIDER ELECTRIC/SIEMENS
74.	OVERLOAD RELAYS WITH BUILT-IN SINGLE-PHASE PREVENTER	SCHNEIDER ELECTRIC/SIEMENS
75.	CURRENT TRANSFORMER	GILBERT & MAXWELL/ AUTOMATIC ELECTRIC
76.	ROTARY SWITCH	SCHNEIDER ELECTRIC/SIEMENS
77.	TIMER DELAY RELAY	SCHNEIDER ELECTRIC/SIEMENS
78.	TIMER	ASIA BROWN/SIEMENS/GE POWER
79.	SELECTOR SWITCH, TOGGLE SWITCH	KAYCEE/EQUIVALENT
80.	CHANGE OVER SWITCH	HPL-SOCOMEK
81.	ELECTRONIC DIGITAL METER	SCHNEIDER ELECTRIC/SIEMENS
82.	INDICATING LAMPS LED TYPE, PUSH BUTTON	L SCHNEIDER ELECTRIC/SIEMENS
83.	PVC INSULATED ALUMINIUM/ COPPER CONDUCTOR, ARMURED MV CABLE (1100 V GRADE)	HITACHI/NEXANS
84.	METALIC CONDUIT	EQUIVALENT
85.	PVC CONDUIT & ACCESSARIS	ASAHI YUKIZAI CORPORATION
86.	SANDWITCHED CONSTRUCTION BUS DUCTS	CONTROL & SWITCHGEAR-HENIKWON/ SCHNEIDER ELECTRIC
87.	CABLE TRAY (FACTORY FABRICATED)	BRILLTECH
88.	LT JOINTING KIT/TERMINATION	BRILLTECH
89.	BIMETTALIC CABLE LUGS	COMET
90.	NUMERIC TYPE	SIEMENS/WOODWORD
9.	B. ELECTROMAGNETIC TYPE	ABB/AREVA

**LIST OF APPROVED MAKES FOR EQUIPMENT & MATERIALS FIRE FIGHTING SYSTEM**

S. No.	Details of Materials / Equipment	Manufacturer's Name
1.	BUTTERFLY VALVE	AUDCO/ CRANE/KITZ
2.	GATE VALVE	LEADER/ TYCO
3.	NON-RETURN VALVE	ADVANCE/ AUDCO
4.	BALL VALVE	DANFOSS
5.	M.S. FORGED FITTINGS	V.S
6.	DASH FASTENERS	HILTI/ FISHER
7.	AUTOMATIC AIR VENT	CIM
8.	PIPE HANGERS/CLAMPS/SUPPORT	EURO CLAMP/ /GRIPPLE
9.	PAINT	NEROLAC
10.	FIRE HOSE	MINIMAX/EQUIVANT
11.	FIRE HYDRANT VALVE	MINIMAX/EQUIVANT
12.	FIRST AID HOSE REEL DRUM & TUBING	MINIMAX/EQUIVANT
13.	BRANCH PIPE	MINIMAX/EQUIVANT
14.	DOUBLE/SINGLE HEADED LANDING VALVES	MINIMAX/EQUIVANT
15.	FIRE MAN AXE	MINIMAX/EQUIVANT
16.	FIRE BRIGADE INLET CONNECTION	MINIMAX/EQUIVANT
17.	FIRE /SPRINKLER MAIN PUMP/JOCKEY PUMPS	GRUNDFOS/WILLO-MATHER & PLATT/ KSB/EQUIVANT
18.	DIESEL ENGINE	CUMMINES / GRUNDFOS/EQUIVANT
19..	MOTOR	ABB / CUMMINS /EQUIVANT

20.	BATTERY	AUDCO/NEW/EQUIVALENT
21.	BATTERY CHARGER	BCH/HBL/KINETIC
22.	MS PIPE	NIPPON
23.	SPRINKLER HEAD	TYCO/VIKING/NEWAGE/OMEX/EQUIVANT
24.	ALARM CONTROL VALVE	TYCO/VIKING/MINIMAX/EQUIVANT
25.	FLOW SWITCH	SYSTEM SENSOR/HONEYWELL/POTTER
26.	WELDING ROD	ESAB/ ADOR/ SUPERON OERLIKON
27.	PRESSURE SWITCH	SYSTEM SENSOR/HONEYWELL/POTTER
28.	CONTROLS	HONEYWELL/ SIEMENS/ DANFOSS
29.	VIBRATION ELIMINATOR	RESISTOFLEX/ KANWEL
30.	DI FITTINGS & COUPLINGS	NEW/TYCO
31.	HOOTER	HONEYWELL/ SIEMENS/ DANFOSS
32.	SLUICE VALVE	LEADER/ AUDCO
33.	Y STRAINER	KITZ/ AUDCO
34.	NRV VALVE	VIKING/TYCO/HD
35.	WATER CURTAIN NOZZLE	VIKING/TYCO/HD
36.	FIRE EXTINGUISHERS	MINIMAX/EQUIVANT
37.	FLEXIBLE DROP CONNECTION	MINIMAX/EQUIVANT
38.	ELECTRICAL PANNEL DECTION & SUPPERSSION SYSTEM	AVEC /FIRE TREX
39.	PIPE PROTECTION WRAPPING	COATEK
40.	INSPECTOR TEST ASSEMBLY	TYCO/VIKING/VICTAULIC
41.	FIRE BUCKETS	MINIMAX
42.	FOOT VALVE	SMOLENSKY / EMERSON
43.	MECHANICAL SEAL	BURGMANN/SEALOL

44.	PRESSURE GAUGE	SEALOL /EMERALD/FIEBIG
<b>ELECTRICAL ACCESSORIES</b>		
45.	MOTOR CONTROL CENTER	TRICOLITE ELECTRICAL/ADLEC CONTROL SYSTEM
46.	VARIABLE SPEED DRIVES	DANFOS/ABB/SIEMENS
47.	MOULDED CASE CIRCUIT BREAKER(MCB)	SCHNEIDER ELECTRIC/SIEMENS
48.	STARTER CONTACTOR	OSAKA SHOJI KAISHA LTD.
49.	MINIATURE CIRCUIT BREAKER(MCB)	HAGER/ SCHNEIDER ELECTRIC/SIEMENS
50.	OVERLOAD RELAYS WITH BUILT-IN SINGLE-PHASE PREVENTER	SCHNEIDER ELECTRIC/SIEMENS
51.	CURRENT TRANSFORMER	GILBERT & MAXWELL/AUTOMATIC ELECTRIC
52.	ROTARY SWITCH	SCHNEIDER ELECTRIC/SIEMENS
53.	TIMER DELAY RELAY	SCHNEIDER ELECTRIC/SIEMENS
54.	TIMER	SIEMENS/GE POWER
55.	SELECTOR SWITCH, TOGGLE SWITCH	MARUYASU DENGYO
57.	CHANGE OVER SWITCH	MARUYASU DENGYO
56.	ELECTRONIC DIGITAL METER	SCHNEIDER ELECTRIC/SIEMENS
57.	INDICATING LAMPS LED TYPE, PUSH BUTTON	SCHNEIDER ELECTRIC/SIEMENS
58.	PVC INSULATED ALUMINIUM/ COPPER CONDUCTOR, AURMERED MV CABLE (1100 V GRADE)	NIPPON
59.	METALIC CONDUIT	KANSAI/ TOYO
60.	PVC CONDUIT & ACCESSARIS	SUMITOMO/CANTEX
61.	SANDWITCHED CONSTRUCTION BUS DUCTS	CONTROL & SWITCHGEAR-HENIKWON/ SCHNEIDER ELECTRIC

62.	CABLE TRAY (FACTORY FABRICATED)	SLLOTCO/NEEEDO/MEM
63.	LT JOINTING KIT/TERMINATION	RAYCHEM
64.	BIMETTALIC CABLE LUGS	COMET/DOWELLS
65.	NUMERIC TYPE	SIEMENS/WOODWORD
66.	B. ELECTROMAGNETIC TYPE	ABB/AREVA

**NOTE:** All the codes and compliances irrespective of what is mention, shall be the codes and compliances as applicable in Osaka, Japan.

**Makes:** If the makes of the material mentioned here in are not available or single then the contractor may propose the equivalent product of the “make”/manufacturers which is available in Japan fulfilling the local laws and compliances suitable the functions for which is meant and decisions of Engineer in Charge/ ITPO shall be final.

### HVAC

1	<b>Air Handling Units</b>	
1.1	Air Handling Units (High Static)	Daikin/ Mitsubishi/ Midea/Toshiba
1.2	Air Handling Units (Ceiling Suspended)	Daikin/ Mitsubishi/ Midea/Toshiba
1.3	<b>PHI/ Ultra Violet Germicidal Irradiation/BPI</b>	RUKS / Trimed / Ultrapure
1.4	Fan Coil Units	Daikin/ Mitsubishi/ Midea/SINCO
	Chilled water Cassette/Hi-Wall	Samsung/LG/Carrier
1.5	Air-washer/Dry Scrubber/ Wet Scrubber	Trion/
2.	Axial Flow Fans	Kruger/ Nicotra
	HVAC	Daikin, Mitsubishi, Hitachi



	Mechanical ventilation:	Panasonic, Mitsubishi, Toshiba
--	-------------------------	--------------------------------

<b>3.</b>	<b>Ducting &amp; Grilles</b>	
3.1	<i>Factory fabricated duct</i>	Dustech/ Eqra
3.2	Pre-insulated Duct	Mecheasy
3.4	Grilles/Fire Dampers/ Diffusers	TROX/AIR MASTER/GELNSTROM
3.5	Fire Dampers motors	Belimo/Siemens/Danfoss/flowcon

<b>4.</b>	<b>Valves</b>	
4.1	Butterfly Valves	ONDA /Caliphi / Takasago
4.2	Non-Return Valve	ONDA /Caliphi / Takasago
4.3	Balancing Valves/ Control valves	ONDA /Caliphi / Takasago
4.4	Gate/Globe Valves	ONDA /Caliphi / Takasago
4.5	Ball Valves with Strainers	ONDA /Caliphi / Takasago

<b>5.</b>	<b>Chilled Water Pipes</b>	
5.1	Chilled Water Pipes	Nippon/ JFE / ONDA

**BMS**

S. No	Items	Approved Makes
A	Controller/Software	
1	Central Control BMS Server	IBM/HP/DELL
2	Printer	HP/Canon/EPSON
3	Building management System	Siemens- Desigo/Honeywell-TREND / Schneider- Struxureware/ Azbil

4	Building Management Web Based Server Software	Siemens- Desigo/Honeywell-TREND / Schneider- Struxureware / Azbil
5	Programmable & Application Specifier Controller (DDC)	Siemens- Desigo/Honeywell-TREND / Schneider- Struxureware/ Azbil
6	Web Server Engines (Network/Supervisory Controller)	Siemens- Desigo/Honeywell-TREND / Schneider- Struxureware/ Azbil
7	System Intergration Units for 3RD Party software Integration	Siemens- Desigo/Honeywell-TREND / Schneider- Struxureware/ Azbil
8	Enclosure for DDC Controller	Rittal/Adhunik/Schneider/ Azbil
B	Sensor & Field Devices	
1	Immersion type temperature sensors	Azbil/ Honeywell/ Schneider
2	Ultrasonic Thermal Energy Meter/Flow Meter	Envix/ Kamstrup/ Azbil
3	Outside T+RH Sensor	Azbil/ / Schneider
4	Differential pressure Switch Air	Azbil/ / Schneider
5	Differential pressure Switch Water	Azbil/ / Schneider
6	Water Level Switches	Kele/Veskler/Flipro/ABB
7	Flame Proof Level Switches	Kele/Veskler/Flipro/ABB
8	Current Relay	L&T/ABB/Siemens/Situ
9	Room/Duct Type Temp Sensor	Azbil/ / Schneider
10	CO2 Sensor	Azbil/ / Schneider
11	Energy Meter	Schneider/ Azbil/ / Schneider /ABB
12	CO Sensor	Dwyer/Kele/MSR Germany/Greystone
13	Pressure Transmitter Water	Azbil/ / Schneider
14	Differential Pressure Sensor-Air	Azbil/ / Schneider

C	Wiring & Conduiting	
1	Signal Cable, PVC Insulated, tinned Copper	Batra Henley /Polycab/Finolex/Skytone
2	Communication Cable, PVC Insulated, tinned	Batra Henley /Polycab/Finolex/Skytone
3	MS Conduit of 20 & 25 mm dia	BEC/AKG
4	Lan Cable & Switches	D-Link/Belden/Delton/Netgare/CISCO

**Miscellaneous**

<b>List of Approved Makes of Materials</b>		
<b>S.No.</b>	<b>Details of equipment/ material</b>	<b>Make/Manufacturer</b>
1	Lighting fixtures:	Daiko, Koizumi, Hitachi, Endo
2	Sanitary fixtures	toto, inax, panasonic
3	Greasetrap:	Chubum, Kaneso, Hokos
4	Switchboards:	Panasonic, Toshiba, Hitachi, Switches, outlets: Panasonic, Jimbo, Elpa
5	Concrete floor finishing	ABC Shokai, SK KAKen, Aica
6	Floor tiles:	Lixil, Nagoya Mosaic, Advan, vynil floor, tile carpet: Sangetsu, Toli, Lilycolor
7	Water based paint:	SK kaken, Nittoko, Shikoku kasei
8	Pumps:	Iwaki, Tomei Engineering, sem corporation
9	Plasterboard:	Yoshino sekko, Taki Kagaku, Chiyoda ute
10	Railings:	Naka Kogyo, Izumi, Qnet
11	UPS:	Fecorage, Adobanet, Denken Seiki

Note: For any item whose make is not mentioned here prior approval of consultants shall be taken.

All the codes and compliances irrespective of what is mention, shall be the codes and compliances as applicable in Osaka, Japan.

**Makes:** If the makes of the material mentioned here in are not available or single then the contractor may propose the equivalent product of the “make”/manufacturers which is available in Japan fulfilling the local laws and compliances suitable the functions for which is meant and decisions of Engineer in Charge/ ITPO shall be final.

**Note:** The Code given are indicative however the contractor before procuring & executing the work shall ascertain & determine the applicable Japanese codes, which are required to be complied with Osaka Japan, and only there after the respective material should be used.

**END OF TECHNICAL specifications**